

Algebra-Based College Physics: Part II

Electricity to Nuclear Physics

Ulrich Zürcher



Download free books at

Ulrich Zürcher

Algebra-Based College Physics: Part II

Electricity to Nuclear Physics

Algebra-Based College Physics: Part II – Electricity to Nuclear Physics

1st edition

© 2013 Ulrich Zürcher & bookboon.com

ISBN 978-87-403-0426-8

Contents

13	Electricity	6
13.1	Electric charges and forces	6
13.2	Electric Field	10
13.3	Work and Electrostatic Potential	15
13.4	Capacitor and Dielectric Material	19
13.5	Capacitors in Series and Parallel	22
14	DC-circuits	25
14.1	Electric Circuits	27
14.2	RC-circuit	35
15	Magnetic Fields	37
15.1	Magnetic forces and magnetic fields	38
15.2	Electromagnetic Induction	46
16	Electromagnetic Waves	51

www.sylvania.com

**We do not reinvent
the wheel we reinvent
light.**

Fascinating lighting offers an infinite spectrum of possibilities: Innovative technologies and new markets provide both opportunities and challenges. An environment in which your expertise is in high demand. Enjoy the supportive working atmosphere within our global group and benefit from international career paths. Implement sustainable ideas in close cooperation with other specialists and contribute to influencing our future. Come and join us in reinventing light every day.

Light is OSRAM

**OSRAM
SYLVANIA**

17	Geometric Optics	55
17.1	Mirrors	59
17.2	Lenses	64
18	Physical Optics	70
19	Special Relativity	75
20	Quantum Physics	78
20.1	Photons	78
20.2	Wave nature of particles	83
20.3	Atomic Physics	86
21	Nuclear Physics	89



Discover the truth at www.deloitte.ca/careers

Deloitte.

© Deloitte & Touche LLP and affiliated entities.



Click on the ad to read more

13 Electricity

13.1 Electric charges and forces

Some particles have a separate quality that is called “charge.” Charge and mass are completely unrelated. The origin of electric charge is microscopic: electrons are negatively charged and protons are positively charged, the magnitude of the charge is the same:

$$Q_e = -e \quad Q_p = +e, \quad (43)$$

where

$$e = 1.602 \times 10^{-19} \text{ C} \quad (44)$$

is the elementary charge. The notion of positive and negative charge is a convention [proposed by B. Franklin who was also a founding father of the U.S.].

There is no simple way to relate the unit of charge C for ‘Coulomb’ to other units. The other building block of an atom is the neutron, which carries no charge. If N_e is the number of electron and N_p is the number of protons, then $Q = N_e(-e) + N_p e = (N_p - N_e)e$ is the net charge: we say that the charge is quantized. If an object is uncharged, the number of electrons and protons are the same so that $Q = (N_p - N_e)e = 0 \cdot e = 0$. For a macroscopic object, e.g., a glass rod “charged” by rubbing with a cat [or rabbit] felt, the number $N = N_p - N_e$ is enormous, typically a fraction of the Avogadro number, so that the charge $Q = Ne$ is macroscopic and the addition or subtraction of a few electrons does no change the total charge. As a result the quantized nature of charge can usually be ignored in macroscopic measurements.

Example 1: Calculate the excess number of electron in a sample of 1 g of carbon ^{12}C that has a net charge of 0.5 nC.

Solution: We have the number of moles $n = 1/12$ so that $N_A/12$. Since every (neutral) carbon has 6 electrons and protons [and 6 neutrons], we have

$$N_e^0 = N_p^0 = 6N = \frac{N_A}{2} = 3.0 \times 10^{22}.$$

The number of excess electrons is

$$N = \frac{Q}{e} = \frac{0.5 \times 10^{-9} \text{ C}}{1.602 \times 10^{-19} \text{ C}} = 3.1 \times 10^9.$$

Thus the fraction of excess electrons is

$$f = \frac{N}{N_e^0} = \frac{3.1 \times 10^9}{3.0 \times 10^{22}} \simeq 1 \times 10^{-13};$$

Discussion: The fraction of excess electrons is very small.

Electric charge is conserved and charges cannot be created or destroyed. Good heat conductors are usually also good conductors of electricity (such as metals); electrons are tightly bound to insulators. An object can be charged by adding or removing electrons [‘charging by contact’]. If a charged object [say, positively] is brought close to an uncharged metal, the electrons of the metal move towards the charged rod, so that there is a depletion of electrons at the other end. We say that the metal is charged by ‘induction.’

Coulomb’s Law: It is found that like charges repel and unlike charges attract. Coulomb’s law states that the magnitude of the force between charges Q_1 and Q_2 is proportional to the charges and inversely proportional to distance (radius) between them:

$$F = |\vec{F}| = k \frac{|Q_1||Q_2|}{r^2}, \quad (45)$$

where

$$k = 8.99 \times 10^9 \frac{\text{N} \cdot \text{m}^2}{\text{C}^2}. \quad (46)$$

We use the notation that \vec{F}_{12} is the force on the charge Q_1 due to the charge Q_2 .

We can also write Coulomb’s law in terms of the electric permittivity of vacuum $\epsilon_0 = 8.85 \times 10^{-12} \text{ C}^2/\text{N} \cdot \text{m}^2$ such that $k = 1/4\pi\epsilon_0$. In *dielectric* material

$$F_{12} = |\vec{F}_{12}| = \frac{k}{\kappa} \frac{|Q_1||Q_2|}{r^2},$$

where k is the dielectric constant. We have $k = 1$ for free space (or vacuum) [definition] and $k \simeq 80.4$ for liquid water.

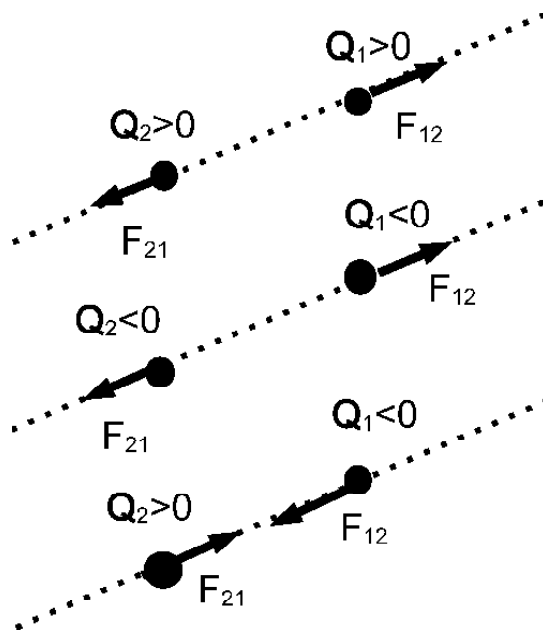

The force \vec{F}_{12} on the charge Q_1 due to charge Q_2 is equal and opposite to the force \vec{F}_{21} on the charge Q_2 due to the charge Q_1 , $\vec{F}_{12} = -\vec{F}_{21}$; [this is Newton's third law], and are directed along the line connecting Q_1 and Q_2 .

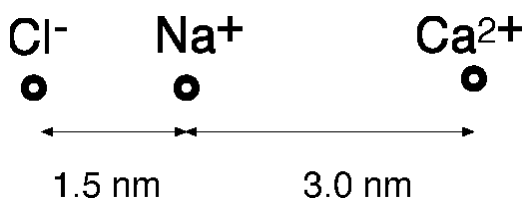

Example 2: A chlorine atom [Cl^-], sodium atom [Na^+], and a calcium atom [Ca^{2+}] are suspended in liquid water as shown. Find total electric force on sodium ion.

Solution: Force due to Cl^- :

$$F_1 = \frac{9.0 \times 10^9 \text{ N} \cdot \text{m}^2/\text{C}^2}{80.4} \cdot \frac{1.6 \times 10^{-19} \text{ C} \cdot 1.6 \times 10^{-19} \text{ C}}{(1.5 \times 10^{-9})^2} = 1.27 \times 10^{-12} \text{ N},$$

directed towards the Cl^- atom, and force due to Ca^{2+} :

$$F_2 = \frac{9.0 \times 10^9 \text{ N} \cdot \text{m}^2/\text{C}^2}{80.4} \cdot \frac{1.6 \times 10^{-19} \text{ C} \cdot 3.2 \times 10^{-19} \text{ C}}{(3.5 \times 10^{-9})^2} = 6.4 \times 10^{-13} \text{ N},$$

directed away from the Ca^{2+} . Thus the two forces point in the same direction and

$$F_{\text{total}} = F_1 + F_2 = 1.9 \times 10^{-12} \text{ N}.$$

If charges are not along a line, the forces must be added using vector addition:

$$\vec{F}_1 = \vec{F}_{12} + \vec{F}_{13}. \quad (47)$$

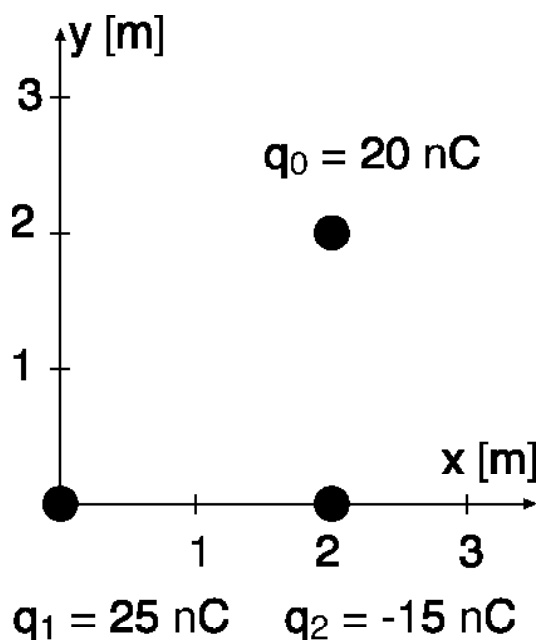

Example 3: Charges $q_1 = 25 \text{ nC}$ and $q_2 = -15 \text{ nC}$ are placed at $(x_1 = 0, y_1 = 0)$ and $(x_2 = 2.0 \text{ m}, y_2 = 0)$, respectively. Calculate the force on the charge q_0 at $(x_0 = 2.0 \text{ m}, y_0 = 2.0 \text{ m})$.

Solution: We calculate use vector sum: $\vec{F} = \vec{F}_1 + \vec{F}_2$, by adding the components. We first calculate the magnitudes of the forces. Since $r_{10} = \sqrt{2} \cdot 2.0 \text{ m}$, we find $|\vec{F}_{1,0}| = 5.62 \times 10^{-7} \text{ N}$. Similarly, $r_{20} = 2.0 \text{ m}$ and $|F_{20}| = 6.74 \times 10^{-7} \text{ N}$. Now compute the x and y components of the two forces:

$$F_{10,x} = F_{10} \cos 45^\circ = 3.97 \times 10^{-7} \text{ N}, \quad F_{10,y} = F_{10} \sin 45^\circ = 3.97 \times 10^{-7} \text{ N},$$

and

$$F_{20,x} = 0, \quad F_{20,y} = -6.74 \times 10^{-7} \text{ N}.$$

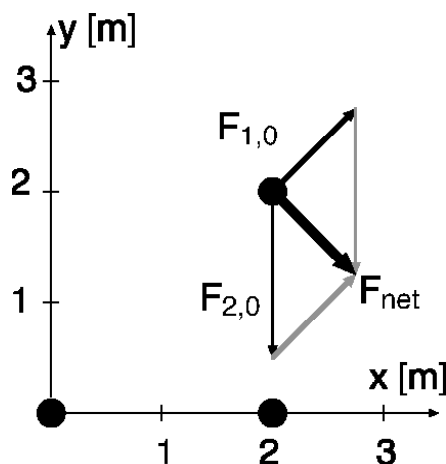

We get for the total force $\vec{F} = \vec{F}_{10} + \vec{F}_{20}$ in component form,

$$\begin{aligned} F_x &= F_{10,x} + F_{20,x} \\ &= 3.97 \times 10^{-7} \text{ N} + 0 = 3.97 \times 10^{-7} \text{ N} \\ F_y &= F_{10,y} + F_{20,y} \\ &= 3.97 \times 10^{-7} \text{ N} - 6.74 \times 10^{-7} \text{ N} = -2.8 \times 10^{-7} \text{ N}. \end{aligned}$$

We get for the magnitude

$$|\vec{F}| = \sqrt{F_x^2 + F_y^2} = \sqrt{(3.97 \times 10^{-7} \text{ N})^2 + (-2.8 \times 10^{-7} \text{ N})^2} = 4.84 \times 10^{-7},$$

and direction

$$\tan \theta = \frac{F_y}{F_x} = \frac{-2.8 \times 10^{-7} \text{ N}}{3.97 \times 10^{-7} \text{ N}} = -0.698, \quad \rightarrow \quad \theta = -34.9^\circ.$$

13.2 Electric Field

The gravitational force on an object with mass m in the Earth gravitational field is given by $F = mg = GmM_E/R_E^2$. We define the gravitational field $F/m = GM_E/R_E^2$ and we say that the gravitational field is produced by the Earth $g = GM_E/R_E^2$. We use the analogous definition for static electric forces. We consider a ‘test charge’ q_0 [corresponding to the object with mass m] and a charge q [corresponding to the Earth with mass M_E]. We use \vec{F} that the charge q is exerting on q_0 . The electric field “felt” by the test charge is defined:

$$\vec{E} = \frac{\vec{F}}{q_0}, \tag{48}$$

with unit $[E] = \text{N/C}$. The magnitude of the electric field produced by the charge q at a distance r :

$$|\vec{E}| = \frac{kq}{r^2}.$$

For a point charge, the electric field is in radial direction. The electric field points away from a positive charge and towards a negative charge.

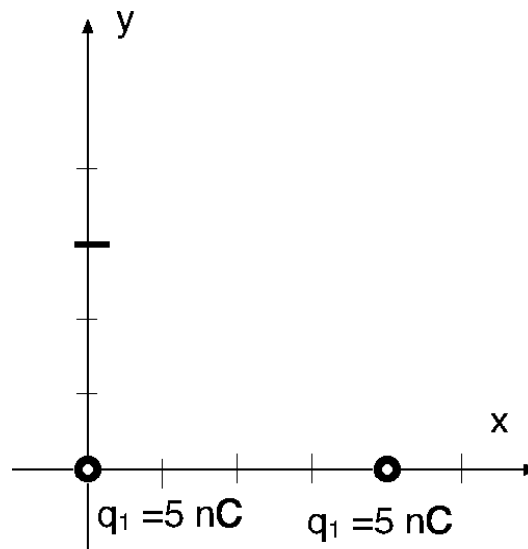

SIMPLY CLEVER

ŠKODA



We will turn your CV into
an opportunity of a lifetime



Do you like cars? Would you like to be a part of a successful brand?
We will appreciate and reward both your enthusiasm and talent.
Send us your CV. You will be surprised where it can take you.

Send us your CV on
www.employerforlife.com



Click on the ad to read more

Example 4 : Charge $q_1 = 5 \text{ nC}$ at origin and the charge $q_2 = 5 \text{ nC}$ at $x = 8 \text{ cm}$. Find electric field at P_2 at $y = 6 \text{ cm}$.

Solution: We calculate the strength of the two electric fields:

$$|\vec{E}_1| = 8.99 \times 10^9 \frac{\text{N} \cdot \text{m}^2}{\text{C}^2} \cdot \frac{5 \times 10^{-9} \text{ C}}{(6 \times 10^{-2} \text{ m})^2} = 1.25 \times 10^3 \frac{\text{N}}{\text{C}}$$

$$|\vec{E}_2| = 8.99 \times 10^9 \frac{\text{N} \cdot \text{m}^2}{\text{C}^2} \cdot \frac{5 \times 10^{-9} \text{ C}}{(1 \times 10^{-1} \text{ m})^2} = 4.5 \times 10^3 \frac{\text{N}}{\text{C}}$$

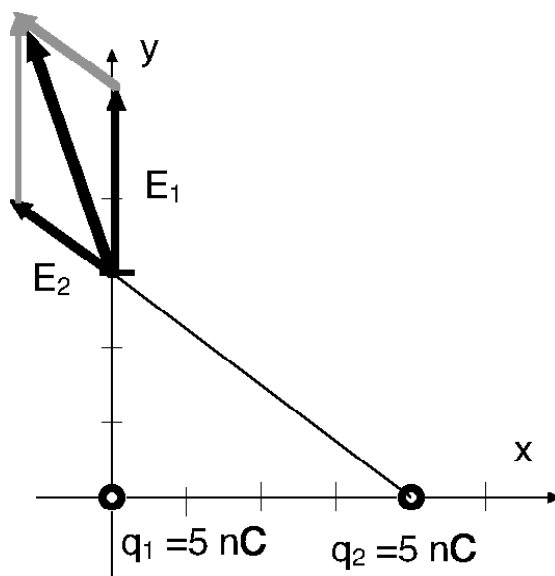

Now for the components

$$E_{1,x} = 0, \quad E_{1,y} = 1.25 \times 10^4 \frac{\text{N}}{\text{C}}$$

Note that $\cos \theta_2 = -0.8$ and $\sin \theta_2 = 0.6$ and

$$E_{2,x} = -3.6 \times 10^3 \frac{\text{N}}{\text{C}} \quad E_{2,y} = +2.7 \times 10^3 \frac{\text{N}}{\text{C}}$$

The total electric field follows:

$$E_x = E_{1,x} + E_{2,x} = -3.6 \frac{\text{kN}}{\text{C}}, \quad E_y = E_{1,y} + E_{2,y} = 15.2 \frac{\text{kN}}{\text{C}}$$

We thus find the magnitude:

$$E = \sqrt{E_x^2 + E_y^2} = \sqrt{\left(-3.6 \frac{\text{kN}}{\text{C}}\right)^2 + \left(15.2 \frac{\text{kN}}{\text{C}}\right)^2} = 15.6 \frac{\text{kN}}{\text{C}}$$

and the direction

$$\tan \theta = \frac{E_y}{E_x} = \frac{15.2 \text{ kN/C}}{(-3.6 \text{ kN/C})} \longrightarrow \theta = 103.3^\circ.$$

The product of electric field [or more precisely, the *normal* component of the electric field] and area is called *electric flux* $\Phi_E = EA$. For the spherical surface of radius r around the charge q , we find $\Phi_E = kq/r^2 \cdot 4\pi r^2 = q/\epsilon_0$, where we used $k^{-1} = 4\pi\epsilon_0$. That is, the total flux through the closed spherical surface is independent of the surface and only depends on the enclosed charge. This is called *Gauss' law*, and can be used to calculate the electric field in the case of symmetrical charge distributions.

The gravitational field near the Earth surface is very nearly uniform [i.e., it has the same magnitude and the same direction]. The electrostatic analog is a metal plate with area A that carries the charge Q . We define the *surface charge density*:

$$\sigma = \frac{Q}{A}, \quad (49)$$

with unit $[\sigma] = \text{C/m}^2$.

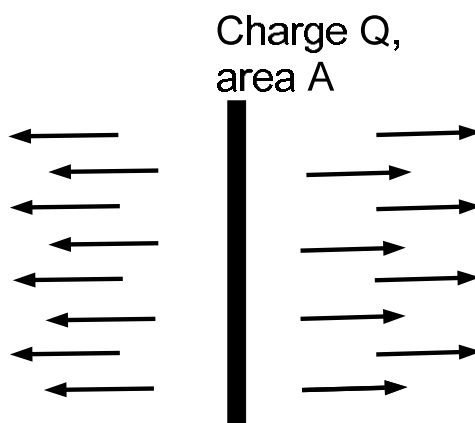

For a single plate, the magnitude of the electric field is given by

$$E = \frac{|\sigma|}{2\epsilon_0}.$$

In the figure, the plate is positively charged since the electric field points away from it. A (parallel-plate) capacitor is an arrangement of two identical plates one positively charged and the other negatively charged. The electric field inside the capacitor is given by

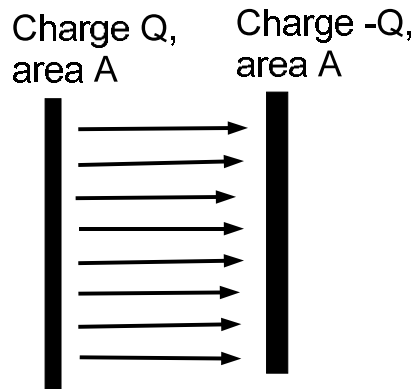

$$E = \frac{|\sigma|}{\epsilon_0}$$

and is zero outside.

Electric field lines are often drawn to visualize electric fields. The ‘density’ of lines is proportional to the strength [magnitude] of the electric field. The direction of the electric field is determined by the tangent line. Electric field lines start at positive charges and end at negative charges. If the total charge of the system is nonzero, some electric field lines extend to infinity.

I joined MITAS because
I wanted **real responsibility**

The Graduate Programme
for Engineers and Geoscientists
www.discovermitas.com



Month 16

I was a construction
supervisor in
the North Sea
advising and
helping foremen
solve problems

Real work
International opportunities
Three work placements



 **MAERSK**

13.3 Work and Electrostatic Potential

Work done by the force F is defined $W = F s \cos \theta$, where θ is the angle between force and displacement. For both the gravitational and electric force, the work is independent of the path and only depends on the initial and final position: Potential energy

$$W = - [EPE_f - EPE_i], \quad (50)$$

where EPE is the electrostatic potential energy.

In the case of the gravitational potential energy near the Earth's surface, we have $PE = mgy$; that is, it depends on the mass of the object. We define the gravitational potential as potential energy per mass, $V_{\text{gravity}} = PE/m = gh$, so that in a topographic map, lines of equal altitude $y = h = \text{const}$ are *equipotential lines*. In the context of electrostatic, we define electric potential V by the electrostatic potential energy of a test charge q_0 :

$$V = \frac{EPE}{q_0}, \quad (51)$$

with unit $[V] = J/C = V$ ["Volts"] (it is a unfortunate situation that the quantity and the unit use the same letter). Recall that the change in the potential energy is equal to *minus* the work done on the system: $\Delta PE = -W$. Thus

$$\Delta V = -\frac{W}{q}. \quad (52)$$

This relation is often used to calculate the work done on the charge q_0 from the potential difference ΔV . Since $W = F\Delta s$ and $F = qE$, we find $\Delta V = -F\Delta s/q_0 = -(q_0 E\Delta s)/q_0$ so that for the electric field

$$E = -\frac{\Delta V}{\Delta s}. \quad (53)$$

The expression on the RHS is called the negative gradient of the potential. This relation yields another unit for the electric field $[E] = V/m$. The electrostatic potential produced by a point charge a at the radius r follows

$$V = \frac{kq}{r}. \quad (54)$$

This expression assumes that the electrostatic potential is zero far away [at "infinity"]. The potential is positive [negative] depending on whether the charge q is positive [negative].

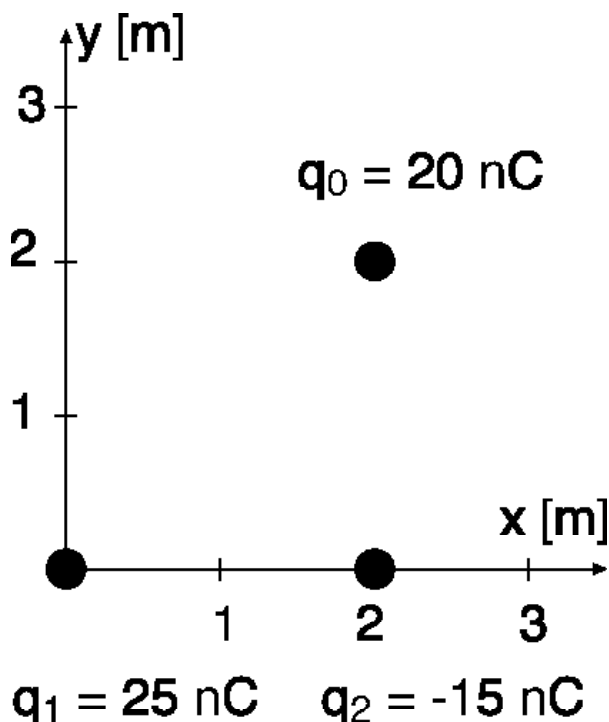

Example 5: Two charges q_1 and q_2 are placed on the xy -plane as shown. **a)** Calculate the electric potential at the location of the charge q_0 . **b)** Calculate the electrostatic potential energy of the charge q_0 and **c)** interpret your result.

Solution: We have $r_1 = 2.83 \text{ m}$ and $r_2 = 2.0 \text{ m}$. Then

$$V_1 = 8.99 \times 10^9 \frac{\text{Nm}^2}{\text{C}^2} \frac{25 \times 10^{-9} \text{ C}}{2.83 \text{ m}} = 79.5 \text{ V}$$

$$V_2 = 8.99 \times 10^9 \frac{\text{Nm}^2}{\text{C}^2} \frac{(-15 \times 10^{-9} \text{ C})}{2.83 \text{ m}} = -67.4 \text{ V}$$

The electrostatic potential at the location of the charge q_0 follows by addition:

$$V_{\text{total}} = V_1 + V_2 = 79.5 \text{ V} + (-67.4 \text{ V}) = 12.1 \text{ V}.$$

Thus the potential energy of the charge q_0 is

$$\text{EPE} = q_0 V_{\text{total}} = 20 \times 10^{-9} \text{ C} \cdot 12.1 \text{ V} = 2.4 \times 10^{-7} \text{ J}.$$

The electrostatic potential energy of the test charge is zero when it is far away from the charges q_1 and q_2 . That is, the electrostatic potential energy increases when the test charge is moved from far away to $(x_0 = 2.0 \text{ m}, y_0 = 2.0 \text{ m})$; this implies that work has to be done on the charge by an external ‘agent’ [e.g., “us”]. If the charge is released from rest at $(x_0 = 2.0 \text{ m}, y_0 = 2.0 \text{ m})$ it flies off to infinity so that it minimizes its electrostatic potential energy. If the test charge is located on an (dust) particle with mass $m = 1.5 \mu\text{g}$, it acquires a finite speed at infinity. We find from the conservation of energy $\text{KE}_0 + \text{EPE}_0 = \text{KE}_\infty + \text{EPE}_\infty$ so that $mv_\infty^2/2 = \text{EPE}_0$. We thus find the terminal speed

$$v_\infty = \sqrt{\frac{2 \text{EPE}_0}{m}} = \sqrt{\frac{2 \cdot 2.6 \times 10^{-7} \text{ J}}{1.5 \times 10^{-9} \text{ kg}}} = 18.6 \frac{\text{m}}{\text{s}}.$$

The relation between electrostatic potential and energy provides a convenient scale for energy. If $q = e$ [elementary charge] and $\Delta V = 1 \text{ m}$. The change in potential energy is

$$\Delta \text{EPE} = 1.602 \times 10^{-19} \text{ J} \equiv 1.0 \text{ eV}. \quad (55)$$

This unit of energy is called “electron volt.”

Example 6: Calculate the binding energy of the electron in the hydrogen atom. The radius of the electron orbit is equal to Bohr’s radius: $a_0 = 5.29 \times 10^{-11} \text{ m}$.

Solution: We find the electrostatic potential produced by the proton:

$$V = 8.99 \times 10^9 \frac{\text{N} \cdot \text{m}^2}{\text{C}^2} \cdot \frac{1.609 \times 10^{-19} \text{ C}}{5.29 \times 10^{-11} \text{ m}} = 27.2 \text{ V}.$$

We thus find the electrostatic potential energy of the electron:

$$\text{EPE} = -27.2 \text{ eV}.$$

Because the electron undergoes uniform circular motion, we have for the force $mv^2/r = ke^2/r^2$ or $mv^2/2 = ke^2/2r = |\text{EPE}|/2$. The total energy of the electron follows

$$E_{\text{total}} = \text{KE} + \text{EPE} = \frac{\text{EPE}}{2} = -13.6 \text{ eV}.$$

Discussion: The total energy is *negative*; the electron is *bound* to the proton, and the (neutral) hydrogen atom is stable.

Binding energy is the negative work required to disassemble a system (of charges) into constituents [e.g., the proton and electron of a hydrogen atom separated at great distances]. In thermodynamics, the heat vaporization quantifies the energy needed to move individual molecules far away; $L_{\text{vapor}} = 22.6 \times 10^5 \text{ J/kg}$ for water. Since $n = 1,000 \text{ g}/18 \text{ g} = 55.5$ is the number of moles in 1 kg, the vaporization energy per molecule follows $\text{BE} = (22.6 \times 10^5 \text{ J}) / (55.5 \cdot 6.02 \times 10^{23}) = 6.77 \times 10^{-20} \text{ J}$. We now convert this energy to unit of eV: $\text{BE} = (6.77 \times 10^{-20} \text{ J}) / (1.602 \times 10^{-19} \text{ C}) = 0.42 \text{ eV}$ [water].

Substance	L_{fusion} [eV/molecule]	L_{vapor} [eV/molecule]
Carbon dioxide (CO_2)	0.086	0
Chlorine (Cl_2)	0.067	0.21
Helium (He_2)	8.7×10^{-5}	8.7×10^{-4}
Iron	0.14	3.6
Mercury (Hg)	0.024	0.061
Nitrogen (N_2)	0.0075	0.058
Silver	0.12	2.6
Tungsten	0.37	8.5
Water (H_2O)	0.062	0.42

ie business school

#1 EUROPEAN BUSINESS SCHOOL
FINANCIAL TIMES 2013

#gobeyond

MASTER IN MANAGEMENT

Because achieving your dreams is your greatest challenge. IE Business School's Master in Management taught in English, Spanish or bilingually, trains young high performance professionals at the beginning of their career through an innovative and stimulating program that will help them reach their full potential.

- Choose your area of specialization.
- Customize your master through the different options offered.
- Global Immersion Weeks in locations such as London, Silicon Valley or Shanghai.

Because you change, we change with you.

www.ie.edu/master-management | mim.admissions@ie.edu | Facebook | Twitter | LinkedIn | YouTube | Instagram



Source: it AIP Handbook, 3rd ed, D.E. Gray [editor] (McGraw-Hill, New York, 1972). This shows that the macroscopic stability [i.e., cohesion] of matter is determined by electric forces. This is perhaps surprising since the molecules are neutral and have no net charge. We note that the centers of positive and negative charges can separate [the molecules become *polarized*].

13.4 Capacitor and Dielectric Material

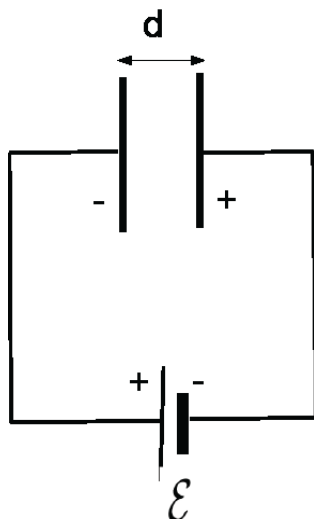

A battery is an electrochemical source of charge that keeps a constant voltage difference, called *electromotive force* \mathcal{E} . We only consider the case of *ideal* batteries for which the potential difference does not depend on the flow of charge. A (parallel plate) capacitor is an arrangement of two parallel plates with cross section A , separated by the distance d . The capacitor is connected to a battery \mathcal{E} and the two plates of the capacitor become positively and negatively charged $Q_+ = -Q_- = Q$ so that the total charge is zero. The voltage difference between the capacitor plates is equal to the electromotive force $V = \mathcal{E}$. We find the electric field from V and the distance between the plates: $E = V/d$. Since $E = \sigma/\epsilon_0 = (Q/\epsilon_0 A)$, where A is the area of the plates. It follows $V/d = Q/(\epsilon_0 A)$, or

$$Q = CV, \tag{56}$$

where we define the *capacitance*:

$$C = \frac{\epsilon_0 A}{d}. \tag{57}$$

The unit of capacitance is *Farad*: $[C] = C/V = F$.

If macroscopic material is inserted between the capacitor plates, the charges of the molecules can separate [“polarize”]. The electric field is reduced $E = E_0/k$, where $k \geq 1$ is a dimensionless material constant [“dielectric constant”]. It follows that more charge can flow on the capacitor plates for the same potential difference:

$$C = \frac{\kappa\epsilon_0 A}{d}. \quad (58)$$

Example 7: The cross-section of a capacitor plates is $A = 4.0 \text{ cm}^2$ [$= 2 \text{ cm} \times 2 \text{ cm}$] and are separated by $d = 2.5 \text{ mm}$. The capacitor is filled with water $k = 80.4$. Calculate the capacitance.

Solution: We find

$$C = 80.4 \cdot 8.85 \times 10^{-12} \frac{\text{C}^2}{\text{N} \cdot \text{m}^2} \frac{4.0 \times 10^{-4} \text{ m}^2}{2.5 \times 10^{-3} \text{ m}} = 1.1 \times 10^{-11} \text{ F} = 0.11 \text{ nF}.$$

Discussion: The Earth can also be considered as a *spherical* capacitor; its capacitance is roughly $C_{\text{Earth}} \simeq 700 \text{ nF}$. This also shows that $C = \text{F}$ would be a gigantic capacitor.

We can visualize the charging of a capacitor in terms of a transfer of positive charges from one side to the other side of the capacitor. If the charge δq is transferred through the voltage difference V' , the work $\delta W = \delta Q \cdot V'$ is done by the battery. This work is stored as (electrostatic) potential energy E_{PE} . When the capacitor is fully charged, the stored energy follows

$$U_E = \frac{1}{2} QV = \frac{1}{2} CV^2. \quad (59)$$

Since $V = E/d$, we find $U_E = \frac{1}{2} (\kappa\epsilon_0 A/d) (Ed)^2 = \frac{1}{2} (\kappa\epsilon_0 E^2) (Ad)$. We note that $\text{Vol} = Ad$ is the volume of the inside of the capacitor, we find the energy density,

$$\frac{U_E}{\text{Volume}} = \frac{1}{2} \kappa\epsilon_0 E^2. \quad (60)$$

Example 8: A parallel-plate capacitor has capacitance $C = 4.5 \text{ pF} = 4.5 \times 10^{-12} \text{ F}$. The plates are separated by the distance $d = 3.0 \text{ cm}$. **a)** The capacitor is charged by a 12 V -battery. Find the charge on the capacitor and the electrostatic potential energy stored in the capacitor! **b)** The battery is now removed. The distance between the capacitor plates is changed from $d = 3.0 \text{ cm}$ to $d = 3.2 \text{ cm}$. Calculate the new capacitance! **c)** What is the potential difference between the plates and find the electrostatic potential energy stored in the new configuration. **d)** Find the force between the two capacitor plates.

Solution: We have for the charge:

$$Q = CV = 4.5 \times 10^{-12} \text{ F} \cdot 12 \text{ V} = 5.4 \times 10^{-11} \text{ C} = 54 \text{ pC}.$$

We have for the energy stored in the capacitor:

$$U = \frac{Q^2}{2C} = \frac{(54 \times 10^{-12} \text{ C})^2}{2 \cdot 4.5 \times 10^{-12} \text{ F}} = 3.24 \times 10^{-10} \text{ J} = 0.324 \text{ nJ}.$$

We have $C \sim 1/d$ so that

$$\frac{C}{C'} = \frac{1/d}{1/d'} = \frac{d'}{d} \quad \rightarrow \quad C' = \frac{d}{d'}C = \frac{3.0 \text{ cm}}{3.2 \text{ cm}} \cdot 4.5 \text{ pF} = 4.2 \text{ pF}.$$

The charge remains constant. Thus

$$V' = \frac{Q}{C'} = \frac{54 \text{ pC}}{4.2 \text{ pF}} = 12.9 \text{ V}$$

and the energy:

$$U' = \frac{Q^2}{2C'} = \frac{(5.4 \times 10^{-11} \text{ C})^2}{2 \cdot 4.2 \times 10^{-12} \text{ F}} = 3.47 \times 10^{-10} \text{ J} = 0.347 \text{ nJ}.$$

Note that the electrostatic potential energy increases: this increase is due to the work done by us against the electrostatic force. We have $\Delta s = d' - d = 3.2 \text{ cm} - 3.0 \text{ cm} = 2 \text{ mm}$. The force then follows from the change in the (electrostatic) potential energy:

$$F_{\text{plates}} = \left| \frac{\Delta U}{\Delta s} \right| = \frac{3.74 \times 10^{-10} \text{ J} - 3.24 \times 10^{-10} \text{ J}}{2 \times 10^{-3} \text{ m}} = 2.5 \times 10^{-8} \text{ N} = 25 \text{ nN}.$$



no.1
nine years
in a row

Syeden
Stockholm

STUDY AT A TOP RANKED INTERNATIONAL BUSINESS SCHOOL

Reach your full potential at the Stockholm School of Economics, in one of the most innovative cities in the world. The School is ranked by the Financial Times as the number one business school in the Nordic and Baltic countries.

Visit us at www.hhs.se





13.5 Capacitors in Series and Parallel

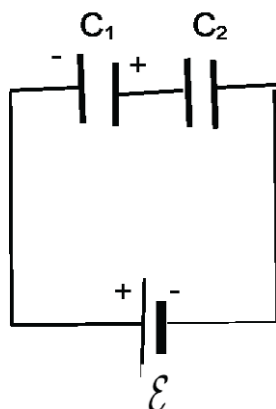

We consider two capacitors C_1 and C_2 connected in series, as shown. The charge on both capacitors are the same $Q_1 = Q_2 = Q$. We note that the voltage drops across the two capacitors add up to the electromotive force $\mathcal{E} = V = V_1 + V_2$. Since $V_1 = Q/C_1$ and $V_2 = Q/C_2$, we write $V = Q/C_{\text{eq}} = Q/C_1 + Q/C_2$, or

$$\frac{1}{C_{\text{eq}}} = \frac{1}{C_1} + \frac{1}{C_2}. \quad (61)$$

We say that C_{eq} is the *equivalent* capacitance of the two capacitors in series.

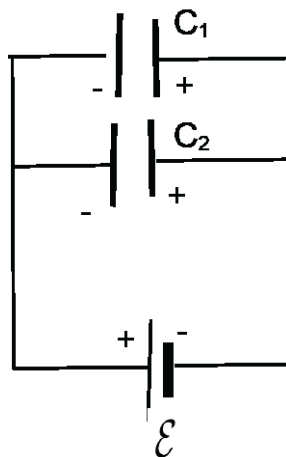

We consider two capacitors C_1 and C_2 connected in parallel, as shown. The two capacitors have the same voltage drop $\mathcal{E} = V = V_1 = V_2$ so that the charges on the two capacitors follow $Q_1 = C_1V$ and $Q_2 = C_2V$. The total charge $Q = Q_1 + Q_2$ determines the equivalent capacitance: $Q = Q_1 + Q_2 = C_1V + C_2V$, or

$$C_{\text{eq}} = C_1 + C_2. \quad (62)$$

We say that C_{eq} is the *equivalent* capacitance of the two capacitors in parallel.

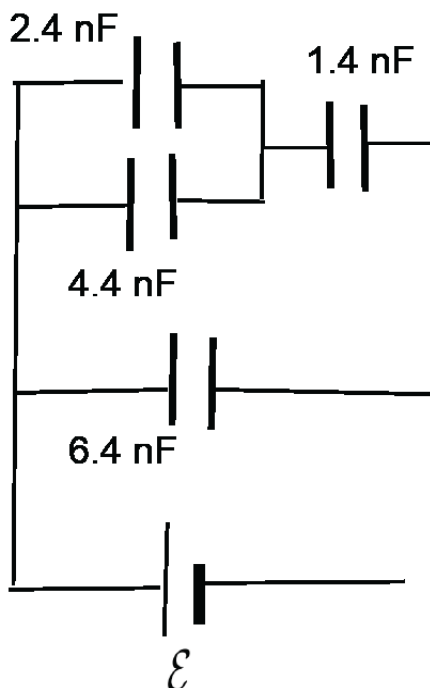

Example 9: Four capacitor $C_1 = 2.4 \text{ nF}$, $C_2 = 4.4 \text{ nF}$, $C_3 = 1.4 \text{ nF}$, and $C_4 = 6.4 \text{ nF}$ are connected as shown. **a)** Find the equivalent capacitance. **b)** If $\mathcal{E} = 12 \text{ V}$, find the voltages across each capacitor.

Solution: Strategy: go from the inside outward. Thus, the equivalent capacitance of C_1 and C_2 connected in parallel is

$$C_{\text{eq},1} = 2.4 \text{ nF} + 4.4 \text{ nF} = 6.8 \text{ nF},$$

so that $C_{\text{eq},1} = 6.8 \text{ nF}$. This capacitor is connected in series to C_3 so that

$$\frac{1}{C_{\text{eq},2}} = \frac{1}{6.8 \text{ nF}} + \frac{1}{1.4 \text{ nF}} = \frac{1}{1.2 \text{ nF}},$$

so that $C_{\text{eq},2} = 1.2 \text{ nF}$. Finally, this capacitor is connected in parallel to C_4 :

$$C_{\text{eq}} = 1.2 \text{ nF} + 6.4 \text{ nF} = 7.6 \text{ nF}.$$

Since $\mathcal{E} = V = 12 \text{ V}$, we have the total charge on all four capacitors

$$Q_{\text{total}} = C_{\text{eq}}V = 7.6 \text{ nF} \cdot 12 \text{ V} = 91.2 \text{ nC}.$$

The charge on the capacitor C_4 is given by

$$Q_4 = C_4 V = 6.4 \text{ nF} \cdot 12 \text{ V} = 76.8 \text{ nC}.$$

The charge on the capacitor $C_{\text{eq},2}$ follows

$$Q_{\text{eq},2} = C_{\text{eq},2} V = 1.2 \text{ nF} \cdot 12 \text{ V} = 14.4 \text{ nC}.$$

The charge on the equivalent capacitor $C_{\text{eq},1}$ and C_3 are the same $Q_{\text{eq},2} = Q_3 = 14.4 \text{ nC}$. We then have for the voltage drops

$$14.4 \text{ nC} = C_{\text{eq},1} V_1 \quad \longrightarrow \quad V_1 = \frac{14.4 \text{ nC}}{6.8 \text{ nF}} = 2.1 \text{ V},$$

and

$$14.4 \text{ nC} = C_3 V_3 \quad \longrightarrow \quad V_3 = \frac{14.4 \text{ nC}}{1.4 \text{ nF}} = 10 \text{ V},$$

We thus have $V_1 + V_3 = 12.0 \text{ V}$. The charge on the capacitors C_1 and C_2 follow:

$$Q_1 = C_1 V_1 = 2.4 \text{ nF} \cdot 2.1 \text{ V} = 5.1 \text{ nC},$$

$$Q_2 = C_2 V_1 = 4.4 \text{ nF} \cdot 2.1 \text{ V} = 9.1 \text{ nC},$$

so that $Q_{\text{eq}} = Q_1 + Q_2 = 5.1 \text{ nC} + 9.1 \text{ nC} = 14.2 \text{ nC}$. The (small) differences are due to round-off errors.

14 DC-circuits

Electric current is the flow of charge q ,

$$I = \frac{\Delta q}{\Delta t} \quad (63)$$

with unit $[I] = \text{C/s} = \text{A}$, or *Ampere*.

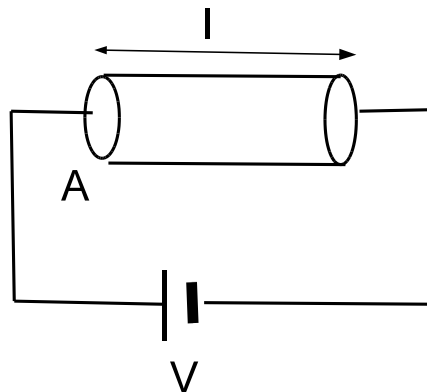

#1
in eco-friendly
attitude

**STUDY AT
LINKÖPING UNIVERSITY, SWEDEN**
RANKED AMONG TOP 50 UNIVERSITIES UNDER 50

Interested in Strategy and Management in International Organisations? Kick-start your career with a master's degree from Linköping University, Sweden.

→ **Click here!**

 **Linköping University**

The flow of charge is analogous to the flow of heat through material. The current is maintained by the the gradient $\Delta V/l$, where ΔV is the potential difference across the material and l is the length of the material. The current is proportional to the cross-sectional area A of the material. We introduce the electric conductivity σ , and write $\Delta q/\Delta t = \sigma A \cdot V/l$. The unit of conductivity is $[\sigma] = \text{A}/(\text{V} \cdot \text{m})$. This is usually written in the form $V = (\rho I/A)l$, or

$$V = RI, \quad (64)$$

where $\rho = \sigma^{-1}$ is the specific resistivity and we introduced the resistance

$$R = \frac{\rho l}{A}, \quad (65)$$

with unit $[R] = \text{V}/\text{A} = \Omega$, or *Ohm*. The unit of resistivity is $[\rho] = \Omega \cdot \text{m}$. The relation $V = RI$ is Ohm's law.

Example 1: The resistivity of silicon is $2.8 \times 10^{-3} \Omega \cdot \text{m}$. Calculate the number of electrons per second through a piece of silicone with length 3.0 cm and cross-sectional area $A = 1.0 \text{ mm}^2$ when the applied voltage is $V = 12.0 \text{ V}$.

Solution: We find the current

$$I = \frac{A}{\rho l} V = \frac{1.0 \times 10^{-6} \text{ m}^2}{2.8 \times 10^{-3} \Omega \cdot \text{m} \cdot 3.0 \times 10^{-2} \text{ m}} \cdot 12.0 \text{ V} = 0.14 \text{ A}.$$

We write $I = (\Delta n/\Delta t)e$ and find

$$\frac{\Delta n}{\Delta t} = \frac{I}{e} = \frac{0.14 \text{ A}}{1.6 \times 10^{-19} \text{ C}} = 9.0 \times 10^{17} \text{ s}^{-1}.$$

Discussion: While this result indicates an enormous number, it is a small fraction of the available electrons [of the order of Avogadro's number $N_A = 6.02 \times 10^{23}$].

Work is required to drive the charge Δq through the potential difference V , $W = \Delta q \cdot V$. Since power is the work by unit time, we find $P = W/\Delta t = (\Delta q \cdot V)/\Delta t$, or

$$P = IV. \quad (66)$$

The energy is dissipated in the form of heat. We use Ohm's law and find

$$P = RI^2 = \frac{V^2}{R}. \quad (67)$$

Example 2: An electric element is used to heat water. The element operates at $V = 120\text{ V}$ and $I = 5\text{ A}$. How long does it take to raise the temperature of 500-g of water from $T_0 = 20^\circ$ to $T_f = 90^\circ$?

Solution: We have the power delivered from the heating element to the water $P = 5\text{ A} \cdot 120\text{ V} = 600\text{ W}$. The heat necessary to raise the temperature:

$$Q = mc\Delta T = 0.5\text{ kg} \cdot 4186 \frac{\text{J}}{\text{kg} \cdot ^\circ\text{C}} \cdot 70^\circ = 1.45 \times 10^5\text{ J}.$$

We thus find the time:

$$t = \frac{Q}{P} = \frac{1.45 \times 10^5\text{ J}}{600\text{ J/s}} = 244\text{ s} \simeq 4.0\text{ min}.$$

Discussion: A convenient unit of work is kWh, or *kilowatt hour*; this is used, for example, as the billing unit by utility companies. Note that $1\text{ kWh} = 3.6 \times 10^6\text{ J}$.

14.1 Electric Circuits

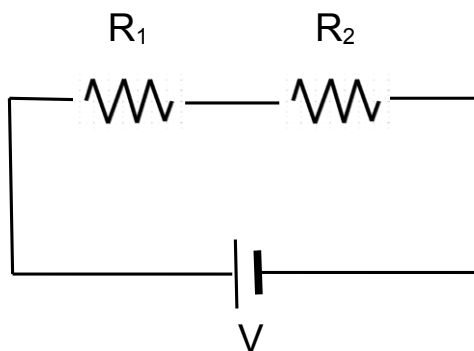

We consider two resistors R_1 and R_2 in series, as shown. The current through the two resistors is the same as the current through the battery I . The voltage drops across the two resistors $V_1 = R_1I$ and $V_2 = R_2I$ add up to the voltage of the battery: $V = V_1 + V_2$. We introduce the equivalent resistance $V = R_{\text{eq}}I$ and find

$$R_{\text{eq}} = R_1 + R_2, \quad (\text{series}). \tag{68}$$

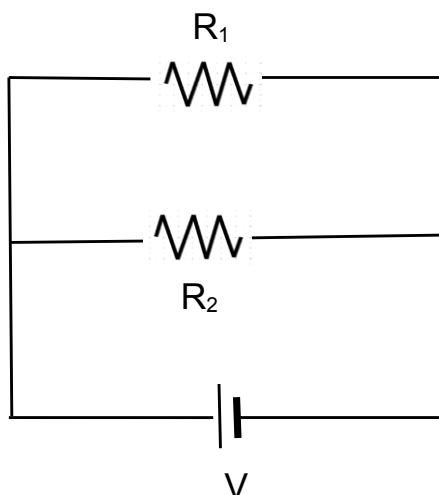

We consider two resistors R_1 and R_2 in parallel, as shown. The potential drops across the two resistors V_1 and V_2 is equal to the voltage of the battery: $V = V_1 = V_2$. Since $I_1 = V/R_1$ and $I_2 = V/R_2$ are the currents through the resistors R_1 and R_2 , respectively, the current through the battery is the sum $I = I_1 + I_2$. We introduce the equivalent resistance $I = V/R_{\text{eq}}$ and find

$$\frac{1}{R_{\text{eq}}} = \frac{1}{R_1} + \frac{1}{R_2}, \quad (\text{parallel}). \quad (69)$$

“I studied English for 16 years but...
...I finally learned to speak it in just six lessons”
Jane, Chinese architect

ENGLISH OUT THERE

Click to hear me talking before and after my unique course download

If several resistors and batteries are connected in a circuit, the currents and voltage drops are determined by *Kirchhoff's rules*. A junction is a point in a circuit where a number of wires are connected: The *Junction Rule* states that the sum of the magnitudes of the current directed into a junction equals the sum of the magnitudes of the current directed out of the junction. A loop is any closed path in a circuit. The *Loop Rule* states the the sum of the potential drops equals the sum of the potential rises. The junction rule is an expression of the conservation of charge: no charge is created or destroyed at a junction. The loop rule is an expression of conservation of energy: if a charge is carried around a closed loop, the net work on the charge is equal to zero.

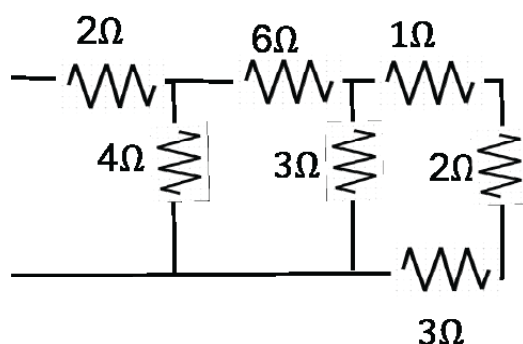

Example 3: a) Find the equivalent resistance of the circuit shown below. b) Find the currents through each resistor if a 14-V battery is connected to the circuit. c) Find the total power dissipated in the circuit.

Solution: We simplify the circuit step-by-step from the inside towards the outside.

Step 1: combine 1Ω, 2Ω and 3Ω resistors [*series*]: $1\ \Omega + 2\ \Omega + 3\ \Omega = 6\ \Omega$

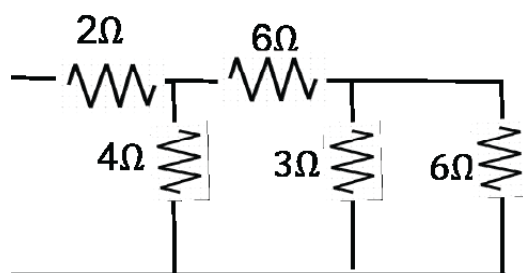

Step 2: combine 3Ω and 6Ω resistors [*parallel*]: $(1/3\Omega + 1/6\Omega)^{-1} = 2\Omega$

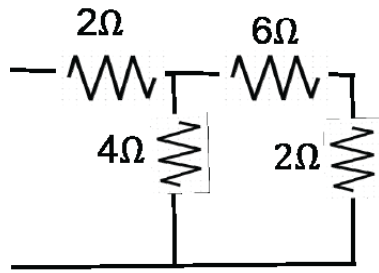

Step 3: combine 2Ω and 6Ω resistors [*series*]: $2\Omega + 6\Omega = 8\Omega$

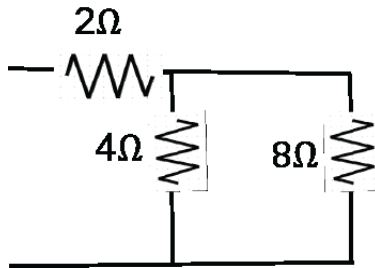

Step 4: combine 4Ω and 8Ω resistors [*parallel*]: $(1/4\Omega + 1/8\Omega)^{-1} = 8\Omega/3$

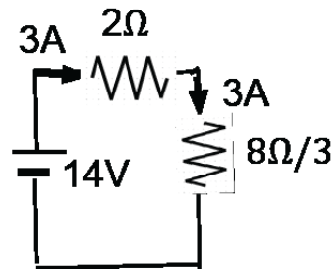

Thus the total resistance is $R_{tot} = 2\Omega + 8\Omega/3 = 14\Omega/3 = 4.67\Omega$

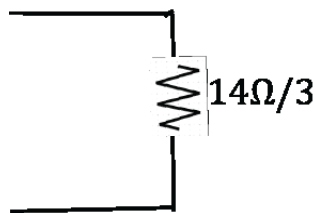

Now, we add a 14-V battery. We find the currents by “going backwards.” The current through the battery:

$$I_{\text{battery}} = 14 \text{ V} / (14/3 \Omega) = 3 \text{ A}:$$

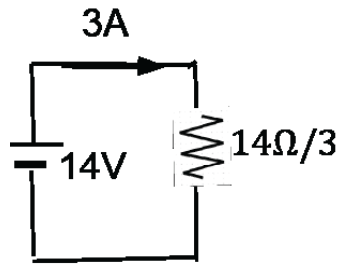

The same current goes through the 2Ω and $8 \Omega/3$ resistors:

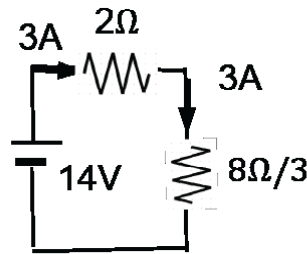

Excellent Economics and Business programmes at:



university of
 groningen



“The perfect start
 of a successful,
 international career.”

CLICK HERE
 to discover why both socially
 and academically the University
 of Groningen is one of the best
 places for a student to be

www.rug.nl/feb/education



The currents through the $4\ \Omega$ and $8\ \Omega$ resistors are determined by two equations: $I_{4\Omega} + I_{8\Omega} = 3\ \text{A}$ and $4\ \Omega \cdot I_{4\Omega} = 8\ \Omega \cdot I_{8\Omega}$, so that $I_{4\Omega} = 2\ \text{A}$ and $I_{8\Omega} = 1\ \text{A}$.

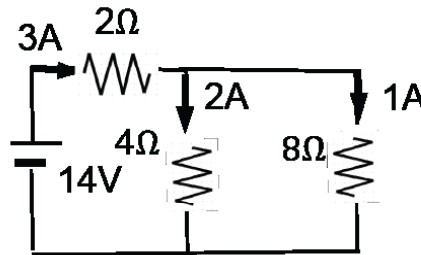

The same 1 A current goes through the $2\ \Omega$ and $6\ \Omega$ resistors.

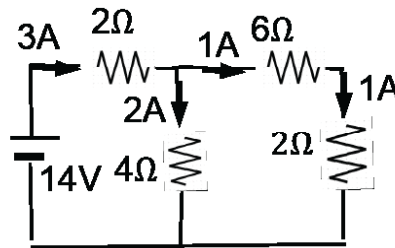

The currents through the $3\ \Omega$ and $6\ \Omega$ resistors are determined by $I_{3\Omega} + I_{6\Omega} = 1\ \text{A}$ and $3\ \Omega \cdot I_{3\Omega} = 6\ \Omega \cdot I_{6\Omega}$. We find $I_{3\Omega} = (2/3)\ \text{A}$ and $I_{6\Omega} = (1/3)\ \text{A}$.

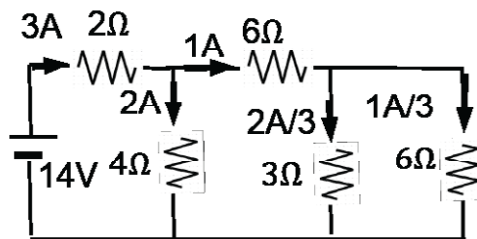

The same $(1/3)\ \text{A}$ current through $1\ \Omega$, $2\ \Omega$ and $3\ \Omega$ resistors:

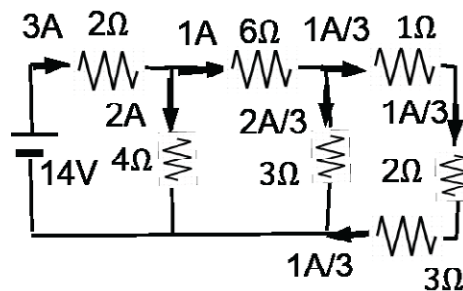

We now calculate the power dissipated in each resistor:

$$\begin{aligned}
 P_{\text{total}} &= [1\ \Omega + 2\ \Omega + 3\ \Omega] \left(\frac{1}{3}\ \text{A}\right)^2 + 3\ \Omega \cdot \left(\frac{2}{3}\ \text{A}\right)^2 + 6\ \Omega \cdot (1\ \text{A})^2 + 4\ \Omega (2\ \text{A})^2 + 2\ \Omega \cdot (3\ \text{A})^2 \\
 &= 0.67\ \text{W} + 1.33\ \text{W} + 6.0\ \text{W} + 16.0\ \text{W} + 18.0\ \text{W} = 42\ \text{W}
 \end{aligned}$$

Equivalently, the power can be calculated from the equivalent resistance:

$$P_{\text{total}} = \frac{V_{\text{battery}}^2}{R_{\text{eq}}} = \frac{(14.0\ \text{V})^2}{4.67\ \Omega} = 42\ \text{W}$$

Discussion: This method is limited to circuits with a single battery; however, there is no limit on the arrangement [and complexity] of resistors.

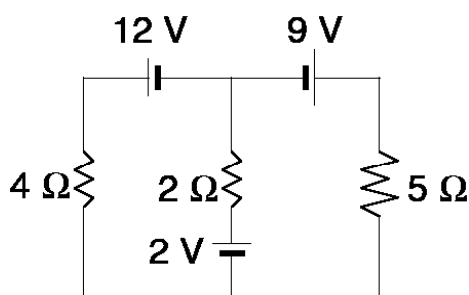

Example 4: The circuit consists of three batteries and three resistors as shown. **a)** Label the circuit and write down Kirchoff's loop and junction rules for the circuit. **b)** Find all the currents in the circuit! **c)** What is the total power dissipated in the circuit? **d)** What is the total power delivered by the three batteries in the circuit?

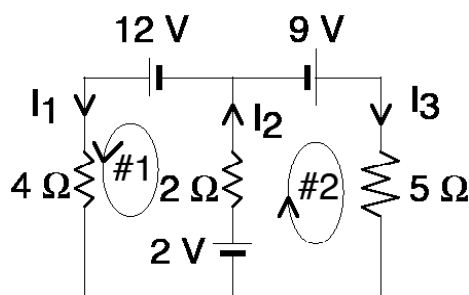

Solution: We have the three currents I_1 , I_2 , and I_3 as shown. We have for the two loops #1 and #2:

$$\#1 : 12 + 2 = 4I_1 + 2I_2$$

$$\#2 : 9 + 2 = 2I_2 + 5I_3$$

and the junction rule:

$$I_2 = I_1 + I_3.$$

Since $I_3 = I_2 - I_1$, we have

$$14 = 4I_1 + 2I_2$$

$$11 = 2I_2 + 5(I_2 - I_1) = 7I_2 - 5I_1$$

so that

$$70 = 20I_1 + 10I_2$$

$$44 = 28I_2 - 20I_1$$

We add these two equations and find $114 = 38I_2$ so that $I_2 = 3 \text{ A}$. Then $14 = 4I_1 + 2 \cdot 3$ so that $I_1 = 2 \text{ A}$ and $I_3 = 3 \text{ A} - 2 \text{ A} = 1 \text{ A}$. We have $P = RI^2$ so that

$$P_{4\Omega} = 4 \Omega \cdot (2 \text{ A})^2 = 16 \text{ W} \quad P_{2\Omega} = 2 \Omega \cdot (3 \text{ A})^2 = 18 \text{ W} \quad P_{5\Omega} = 5 \Omega \cdot (1 \text{ A})^2 = 5 \text{ W}.$$

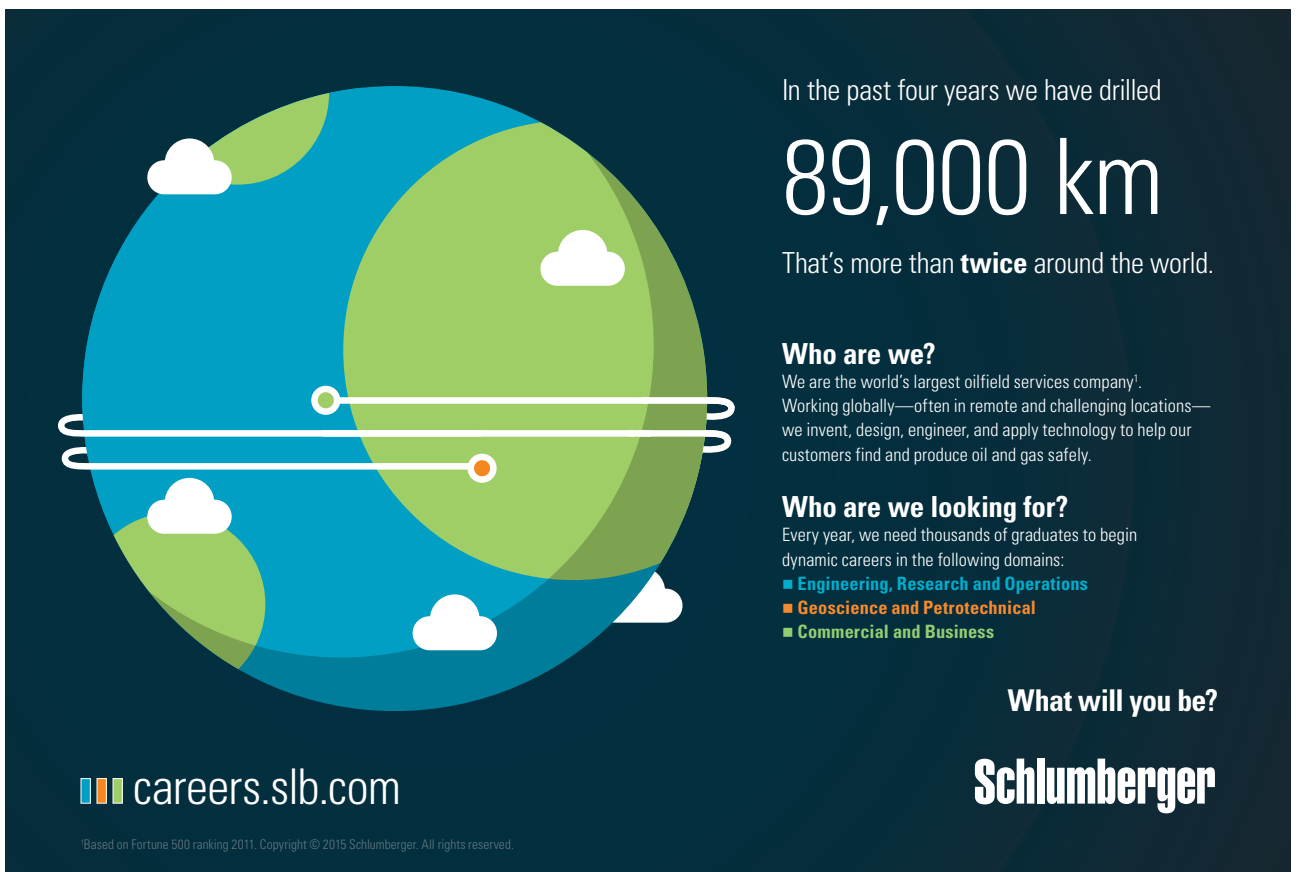

In the past four years we have drilled

89,000 km

That's more than **twice** around the world.

Who are we?
We are the world's largest oilfield services company¹. Working globally—often in remote and challenging locations—we invent, design, engineer, and apply technology to help our customers find and produce oil and gas safely.

Who are we looking for?
Every year, we need thousands of graduates to begin dynamic careers in the following domains:

- Engineering, Research and Operations
- Geoscience and Petrotechnical
- Commercial and Business

What will you be?

careers.slb.com

Schlumberger

¹Based on Fortune 500 ranking 2011. Copyright © 2015 Schlumberger. All rights reserved.

That is, the total power dissipated in the circuit is $P_{\text{tot}} = P_{4\Omega} + P_{2\Omega} + P_{5\Omega} = 39 \text{ W}$.

We have $P_{\text{batt}} = IV$ so that

$$P_{12\text{V}} = 2 \text{ A} \cdot 12 \text{ V} = 24 \text{ W}, \quad P_{2\text{V}} = 3 \text{ A} \cdot 2 \text{ V} = 6 \text{ W}, \quad P_{9\text{V}} = 1 \text{ A} \cdot 9 \text{ V} = 9 \text{ W}.$$

Thus, the total power is $P_{\text{tot}} = P_{12\text{V}} + P_{2\text{V}} + P_{9\text{V}} = 39 \text{ W}$.

Discussion: Note that the circuits may “look” different when they are in fact identical!

14.2 RC-circuit

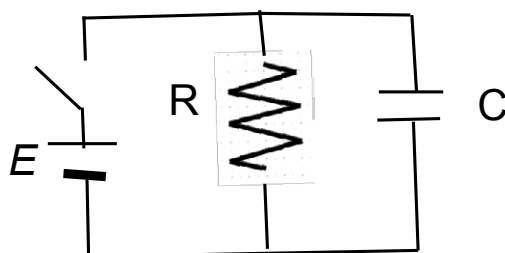

At $t = 0$, capacitor is fully charged by battery: $\mathcal{E} = V_0 = Q_0/C$. The battery is disconnected at $t = 0$. We use the loop rule for times $t > 0$:

$$0 = V_C + V_R = \frac{Q}{C} + RI = \frac{Q}{C} + R \frac{\Delta Q}{\Delta t}$$

and find

$$\frac{\Delta Q}{\Delta t} = -\frac{1}{RC}Q.$$

This shows that the rate of the change of the charge is proportional to the charge, i.e., $\Delta Q/\Delta t \sim Q$. In mathematical terminology, the charge on the capacitor is a *first-order* process, and the time dependence is described by exponential behavior:

$$Q(t) = Q_0 e^{-t/\tau}, \tag{70}$$

where the time constant is given by

$$\tau = RC \tag{71}$$

and $Q_0 = C\mathcal{E}$ is the charge on the capacitor at time $t = 0$.

Example 5: A RC-circuit consists of a resistor $R = 360 \text{ M}\Omega$, a capacitor $C = 12.5 \text{ pF}$, and a battery $\mathcal{E} = 6.0 \text{ V}$. Find the time when the charge on capacitor has dropped to half its original value.

Solution: We have the initial charge

$$Q_0 = \mathcal{E}C = 6.0 \text{ V} \cdot 12.5 \times 10^{-12} \text{ F} = 7.5 \times 10^{-11} \text{ C}.$$

We have $Q = Q_0/2 = 3.75 \times 10^{-11} \text{ C}$. We have the time constant

$$\tau = RC = 3.6 \times 10^8 \Omega \cdot 12.5 \times 10^{-12} \text{ F} = 4.5 \text{ ms}.$$

We then have

$$\ln\left(\frac{Q}{Q_0}\right) = -\ln 2 = -\frac{t}{\tau} \quad \longrightarrow \quad t = \ln 2 \cdot \tau = 3.1 \text{ ms}.$$

15 Magnetic Fields

The discussion of magnetism and magnetic fields mirrors that of electricity and electric fields. We first explore the nature of the magnetic force on electric charges and then we examine the source of magnetic fields.

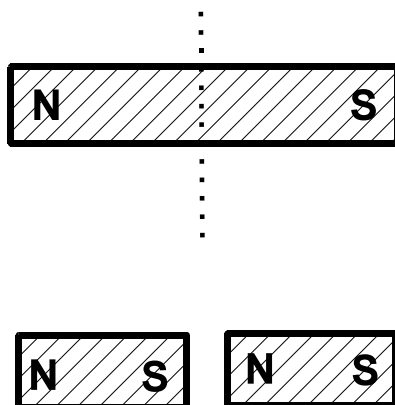

American online

LIGS University

is currently enrolling in the
Interactive Online **BBA, MBA, MSc,**
DBA and PhD programs:

- ▶ enroll **by September 30th, 2014** and
- ▶ **save up to 16%** on the tuition!
- ▶ pay in 10 installments / 2 years
- ▶ Interactive **Online** education
- ▶ visit www.ligsuniversity.com to find out more!

Note: LIGS University is not accredited by any nationally recognized accrediting agency listed by the US Secretary of Education. More info [here](#).



Some materials [copper (Co), nickel (Ni), and iron (Fe)] produce permanent magnetic fields; they are used for ‘refrigerator magnets.’ A magnet has a north and a south pole; however, the poles are not analogues to electric charges. Outside the bar magnet, the magnetic field points from the north to the south pole and they point from the south to the north pole inside the magnet. If a bar magnet is cut into two parts, two bar magnets – both with a north and south pole – are created. That is, magnetic poles cannot be isolated and are always created in pairs.

The Earth [and other planets] have a magnetic field. The magnetic north (south) pole is near the geographic south (north) pole. The polarity of the Earth magnetic field switches during dramatic events called *geomagnetic reversals*. These events are rare and occur in random events. The most recent reversal occurred 780,000 years ago.

15.1 Magnetic forces and magnetic fields

An electric charge is placed in a homogeneous magnetic field \vec{B} . Experiments reveal the following facts: (i) the force is zero, if the charge is at rest $v = 0$; (ii) the force is zero, when the charge moves parallel to the magnetic field $\vec{v} \parallel \vec{B}$; (iii) the force is non-zero, if the force is not parallel to magnetic field. The force is perpendicular to both the magnetic field and the velocity $\vec{F} \perp \vec{v}, \vec{B}$. Because the force is perpendicular to the velocity, the magnetic force is not doing work on the electric charge. Thus, the kinetic energy and the speed of the charged particle are constant.

The motion of the charged particle is described uniform circular motion characterized by the speed v , the radius r and the period $T = 2\pi r/v$. The magnetic force is equal to the ‘centripetal force’ $F_c = mv^2/r$. Experimentally, we observe that (i) the radius is inversely proportional to the magnetic field $r \sim B^{-1}$; (ii) the radius is inversely proportional to the charge, $r \sim q^{-1}$; and (iii) the radius is proportional to the speed $r \sim v$. This behavior can be summarized as

$$r = \frac{mv}{qB}.$$

We use Tesla for the unit of magnetic field:

$$[B] = \text{T} = \frac{\text{kg} \cdot \text{m/s}}{\text{C} \cdot \text{m}} = \frac{\text{N} \cdot \text{s}}{\text{C} \cdot \text{m}}.$$

The Lorentz force follows $F = mv^2/r = mv^2/(mv/qB) = qvB$. The force is perpendicular to both the velocity \vec{v} and \vec{B} . In the general case, the velocity makes the angle θ with the magnetic field, and

$$F = qvB \sin \theta.$$

The direction of the magnetic force is determined by the *right-hand* rule: the velocity is along the direction of the fingers of the right hand, the magnetic field is along the direction of the fingers; then the force on a positive charge is perpendicular to the palm of the hand.

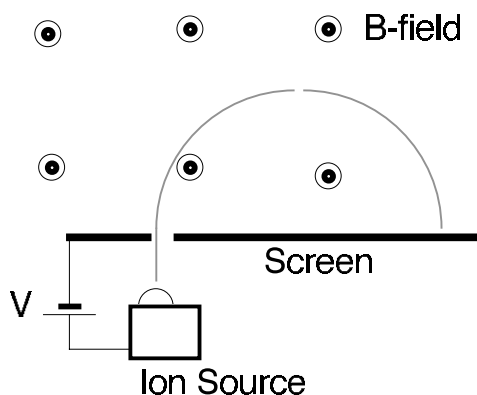

Example 1: A single-charged ion $^{16}\text{O}^+$ is emitted by the source of a mass spectrometer. **a)** The ion is accelerated by the electric field between the source and the metal plate held at the potential difference $V = 1.45 \text{ kV}$. The distance between source and metal plate is $\Delta s = 3.1 \text{ cm}$. Find the speed of the ion as it enters the region with a magnetic field. The mass of the $^{16}\text{O}^+$ -ion is $m = 16 \text{ u}$, where $1 \text{ u} = 1.66 \times 10^{-27} \text{ kg}$ (atomic mass unit). **b)** Find the time for the ion to travel through the electric field. **c)** The $^{16}\text{O}^+$ -ion enters the region with magnetic field. It hits the screen $2.0 \mu\text{s}$ after it was released by the ion source. Find the period of the uniform circular motion and the radius of the orbit. **d)** Find the strength of the magnetic field that produces the desired orbit of the $^{16}\text{O}^+$ -ion?

Solution: We use conservation of energy $e\Delta V = mv^2/2$:

$$v = \sqrt{\frac{2e\Delta V}{m}} = \sqrt{\frac{2 \cdot 1.602 \times 10^{-19} \text{ C} \cdot 1.45 \times 10^3 \text{ V}}{16 \cdot 1.66 \times 10^{-27} \text{ kg}}} = 1.32 \times 10^5 \frac{\text{m}}{\text{s}}$$

We have for the electric field: $E = \Delta V/\Delta s$. The acceleration is $a = eE/m = eV/m\Delta s$, and

$$\frac{1}{2}at^2 = \frac{e\Delta V}{2m\Delta s}t_1^2 = \Delta s,$$

so that

$$t_1 = \sqrt{\frac{2m}{eV}\Delta s} = \sqrt{\frac{2 \cdot 16 \cdot 1.66 \times 10^{-27} \text{ kg}}{1.602 \times 10^{-19} \text{ C} \cdot 1.45 \times 10^3 \text{ V}}} \cdot 3.1 \times 10^{-2} \text{ s} = 0.47 \mu\text{s}.$$

Or, use that the average velocity of the ion is $v_{\text{ave}} = v/2 = 6.6 \times 10^4 \text{ m/s}$. Then $t_1 = \Delta s/v_{\text{ave}}$.

Since $t_{\text{flight}} = t_1 + t_2$, we get for the time inside the magnetic field:

$t_2 = t_{\text{flight}} - t_1 = 2.0 \mu\text{s} - 0.53 \mu\text{s} = 1.53 \mu\text{s}$. Thus, we get for the period:

$$T = 2t_2 = 2 \cdot 1.53 \mu\text{s} = 3.06 \mu\text{s}.$$

Since the velocity is $v = 2\pi r/T$, we find the radius:

$$r = \frac{vT}{2\pi} = \frac{1.32 \times 10^5 \text{ m/s} \cdot 3.06 \times 10^{-6} \text{ s}}{2\pi} = 6.4 \times 10^{-2} \text{ m} = 6.4 \text{ cm}.$$

We find the force $evB = mv^2/r$ so that

$$B = \frac{m \cdot 2\pi r/T}{er} = \frac{2\pi m}{eT} = \frac{2\pi \cdot 16 \cdot 1.66 \times 10^{-27} \text{ kg}}{1.602 \times 10^{-19} \text{ C} \cdot 3.06 \times 10^{-6} \text{ s}} = 0.34 \text{ T}.$$

We note that the combination charge times velocity can be written in terms of an electric current $qv = (q/\Delta t) \cdot (v\Delta t) = I \cdot L$. Thus, the magnetic force can be written $F = I\ell B \sin \theta$, or in terms of force per unit length:

$$\frac{F}{L} = IB \sin \theta, \quad (72)$$

.....Alcatel-Lucent 

www.alcatel-lucent.com/careers

What if you could build your future and create the future?

One generation's transformation is the next's status quo. In the near future, people may soon think it's strange that devices ever had to be "plugged in." To obtain that status, there needs to be "The Shift".



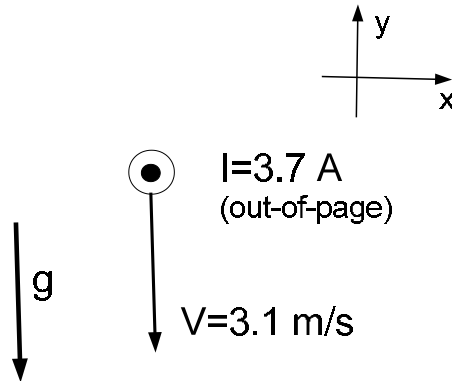

Click on the ad to read more

where θ is the angle between the wire and the direction of the magnetic field. The direction of the force follows from a right-hand rule: fingers in the direction of the fingers, the magnetic field in the direction of the thumb, and the force in the direction of the palm of the hand.

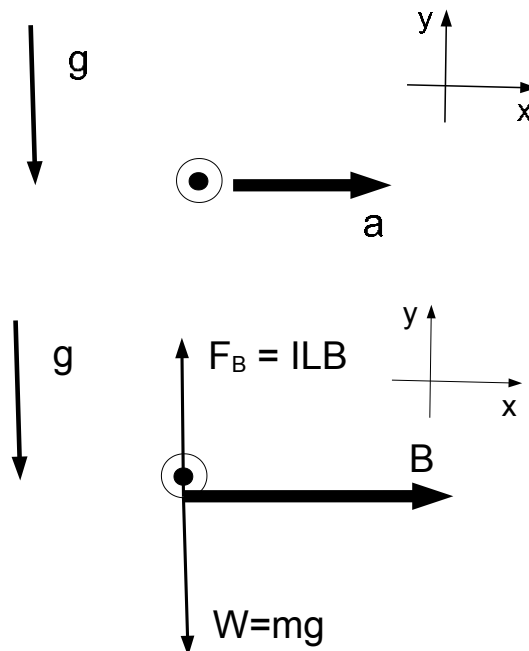

Example 2: A long thin wire with length $L = 23 \text{ cm}$ and mass $m = 4.3 \text{ g}$ carries the current $I = 3.7 \text{ A}$ as shown. The wire moves in the gravitational field of the Earth g . **a)** The rod falls with constant velocity $\vec{v} = -3.1\hat{j}$ [downward] in an unknown homogeneous magnetic field. Draw the free-body diagram for the rod! What is the direction of the magnetic field? **b)** Find the external magnetic field \vec{B} [vector!]. **c)** If the acceleration of the rod is $\vec{a} = 1.3 \text{ m/s}^2 \hat{x}$ [i.e., directed to the right], what is the external magnetic field \vec{B}' [vector!]?

Solution: We have the gravitational force [down] and the magnetic force [up].



We use the first right-hand-rule: $\vec{B} = B\hat{x}$. For the magnitude $mg = ILB$ so that

$$B = \frac{mg}{LI} = \frac{4.3 \times 10^{-3} \text{ kg} \cdot 9.8 \text{ m/s}^2}{0.23 \text{ m} \cdot 3.7 \text{ A}} = 49.5 \text{ mT}.$$

We have $\vec{B}' = B_x\hat{x} - B_y\hat{y}$ with $B_x = 49.5 \text{ mT}$. For the vertical component: $ma = ILB_y$ so that

$$B_y = \frac{ma}{IL} = \frac{4.3 \times 10^{-3} \text{ kg} \cdot 1.3 \text{ m/s}^2}{0.23 \text{ m} \cdot 3.7 \text{ A}} = 6.6 \text{ mT}.$$

An electric charge both “feels” and “produces” electric fields. Similarly, a moving charge both “feels” and “produces” magnetic fields. The general expression for the magnetic field produced by a moving charge [so-called *Biot-Savart* law] is too difficult for an introductory physics course, and we can only discuss two simple cases. (i) The magnetic field produced by a long straight wire has magnetic field lines that are circles in the plane perpendicular to the current. The magnitude of the magnetic field is

$$B = \frac{\mu_0 I}{2\pi r}, \quad (73)$$

with

$$\mu_0 = 4\pi 10^{-7} \frac{\text{T} \cdot \text{m}}{\text{A}}. \quad (74)$$

The orientation of the magnetic field is given by the second right-hand rule: the thumb is directed along the current and then the magnetic field lines are directed along the directions of the curved fingers [i.e., clockwise and counter-clockwise]. (ii) A loop of wire with radius R carries the current I . Then the magnetic field at the center of the loop has magnitude

$$B = \frac{\mu_0 I}{2R}, \quad (\text{dipole field}) \quad (75)$$

The direction of magnetic field is determined by another right-hand rule: the direction of the curved fingers follows the current and the direction of the thumb gives the direction of the magnetic field. (iii) A solenoid a collection of N current loops along the length L so that the number of loops per unit length is given by $n = N/L$. The magnetic field follows

$$B = \mu_0 n I = \mu_0 \frac{N}{L} I \quad (\text{uniform field}). \quad (76)$$

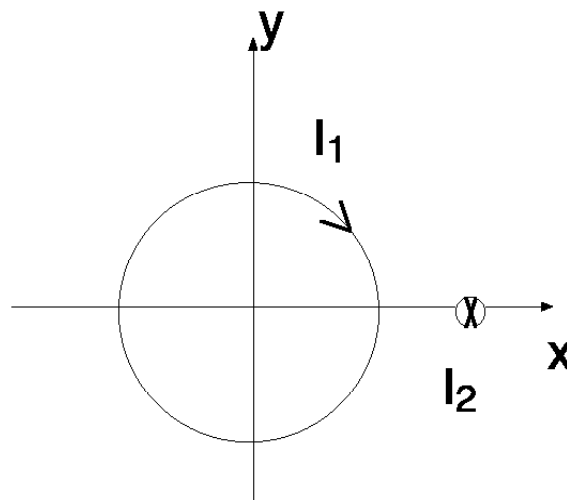

Example 3: A circular loop of wire with radius $r = 4.5$ cm is placed at the origin in the xy -plane, as shown. A long straight wire is placed at $x = 7.5$ cm and is parallel to z -axis. **a)** The current $I_1 = 1.5$ A in the loop is *clockwise*. Find the magnetic field from the current loop at the origin. **b)** The current $I_2 = 4.8$ A in the straight wire is pointed along the *negative* z direction. Find the magnetic field at the origin produced by I_2 . **c)** Find the magnitude and direction of the total magnetic field $\vec{B}_{\text{tot}} = \vec{B}_1 + \vec{B}_2$.



Join the best at
the Maastricht University
School of Business and
Economics!

Top master's programmes

- 33rd place Financial Times worldwide ranking: MSc International Business
- 1st place: MSc International Business
- 1st place: MSc Financial Economics
- 2nd place: MSc Management of Learning
- 2nd place: MSc Economics
- 2nd place: MSc Econometrics and Operations Research
- 2nd place: MSc Global Supply Chain Management and Change

Sources: Keuzegids Master ranking 2013; Elsevier 'Beste Studies' ranking 2012; Financial Times Global Masters in Management ranking 2012

Maastricht University is the best specialist university in the Netherlands (Elsevier)

Visit us and find out why we are the best!
Master's Open Day: 22 February 2014

www.mastersopenday.nl



Click on the ad to read more

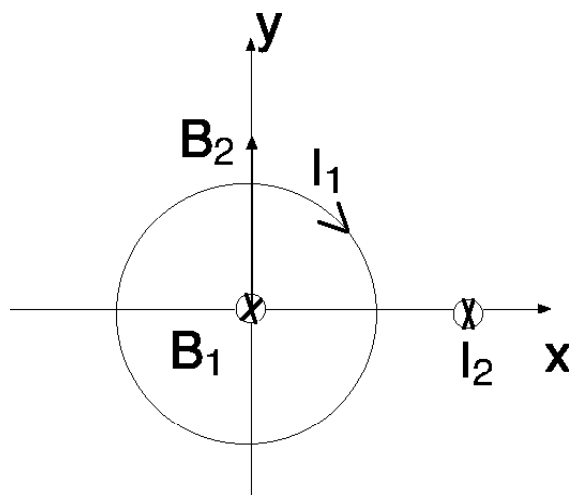

Solution: We have for the magnetic field produced by I_1 :

$$|\vec{B}_1| = \frac{\mu_0 I_1}{2r_1} = \frac{4\pi 10^{-7} \text{ T} \cdot \text{m/A} \cdot 1.5 \text{ A}}{2 \cdot 0.045 \text{ m}} = 2.1 \times 10^{-5} \text{ T.}$$

and use right-hand rule for direction: $\vec{B}_1 = -2.1 \times 10^{-5} \text{ T} \hat{z}$. We have for the magnetic field produced by I_2 :

$$|\vec{B}_2| = \frac{\mu_0 I_2}{2\pi r_2} = \frac{4\pi 10^{-7} \text{ T} \cdot \text{m/A} \cdot 4.8 \text{ A}}{2\pi \cdot 0.075 \text{ m}} = 1.3 \times 10^{-5} \text{ T.}$$

and use right-hand rule for direction: $\vec{B}_2 = 1.3 \times 10^{-5} \text{ T} \hat{y}$.

We have the total magnetic field:

$$|\vec{B}_{\text{tot}}| = \sqrt{B_1^2 + B_2^2} = \sqrt{(-2.1 \times 10^{-5} \text{ T})^2 + (1.3 \times 10^{-5} \text{ T})^2} = 2.5 \times 10^{-5} \text{ T.}$$

The total magnetic field \vec{B}_{tot} lies in the yz -plane. We calculate the angle θ of the magnetic field with respect to the $+y$ -axis:

$$\tan \theta = \frac{|\vec{B}_1|}{|\vec{B}_2|} = \frac{2.1 \times 10^{-5} \text{ T}}{1.3 \times 10^{-5} \text{ T}} = 1.6, \quad \rightarrow \quad \theta = 58.2^\circ.$$

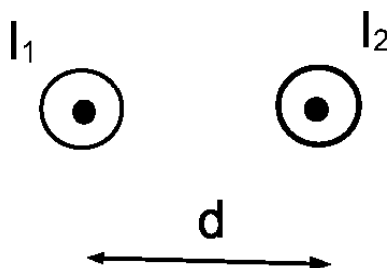

We consider a situation with two parallel wires with currents I_1 and I_2 [in the same direction] at a distance d . The current I_1 (I_2) produces the magnetic field \vec{B}_1 (\vec{B}_2) at the location of the current I_2 (I_1).

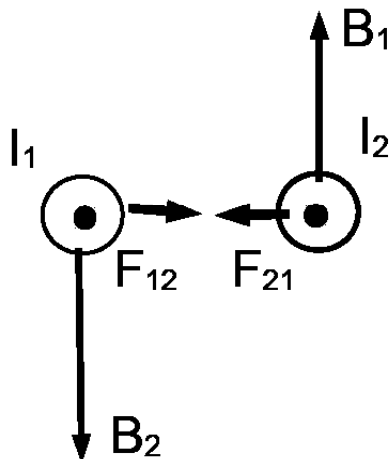

The right-hand rules then gives the forces \vec{F}_{12} (\vec{F}_{21}) on the current wires:

$$\frac{F_{12}}{L} = I_1 B_2 = I_1 \cdot \frac{\mu_0 I_2}{2\pi d} \quad (\text{to the right})$$

$$\frac{F_{21}}{L} = I_2 B_1 = I_2 \cdot \frac{\mu_0 I_1}{2\pi d} \quad (\text{to the left})$$

We thus have for the forces $\vec{F}_{12} = -\vec{F}_{21}$ – which is Newton’s third law i.e., forces appear in pairs:

$$\frac{|\vec{F}_{12}|}{L} = \frac{|\vec{F}_{21}|}{L} = \frac{\mu_0 I_1 I_2}{2\pi d} \quad (77)$$

Example 4: Two wires carry the current $I_1 = I_2 = 1.0$ A; the distance between wires is $d = 1.0$ m. Find the force per unit length between the wires.

Solution: We have

$$\frac{F}{L} = \frac{4\pi \times 10^{-7} \text{ T} \cdot \text{m/A} \cdot (1.0 \text{ A})^2}{2\pi \cdot 1.0 \text{ m}} = 2 \times 10^{-7} \frac{\text{N}}{\text{m}}$$

Discussion: This relationship is used to define the current: “A unit of electric current in the meter-kilogram-second system. It is the steady current that when flowing in straight parallel wires of infinite length and negligible cross section, separated by a distance of one meter in free space, produces a force between the wires of 2×10^{-7} newtons per meter of length. Then for the unit of charge: Coulomb $1 \text{ C} = 1 \text{ A} \cdot 1 \text{ s}$.”

15.2 Electromagnetic Induction

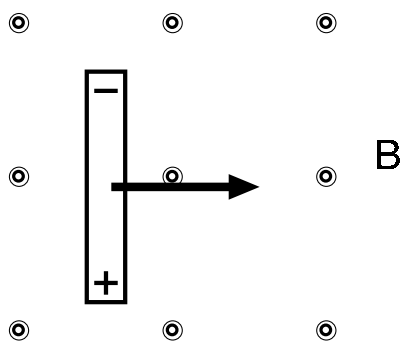

We consider the motion of an electric conductor in a uniform magnetic field. The field is uniform and points out-of-the page. A uncharged rod is moving to the right. The force on positive (negative) charges points downward (upward). Thus, a charge separation between the ends of the rod develops. The accumulation of charge is limited due to electric forces between the separated positive and negative charges. In the stationary state, the electric and magnetic forces cancel out each other: $qvB = qE$. We write the electric field inside the conductor in terms of the potential difference V between the tips: $E = V/L$ and arrive at the expression

$$V = \mathcal{E} = lvB.$$

 [Click on the ad to read more](#)

This voltage is called the motional “EMF” [electromotive force].

This motional EMF is a particular case of a fundamental principle: a changing magnetic field produces a (time-dependent) electric field.

$$\mathcal{E} = -\frac{\Delta\Phi_M}{\Delta t}, \quad \text{with } \Phi_M = BA.$$

B constant and $\Delta A/\Delta t = lv$ so that $|\mathcal{E}| = lvB$. Electric field lines produced by induced currents are closed: i.e., they have no beginning [positive pole] and end [negative pole].

Example 5: A circular loop of wire [radius $r = 5.0$ cm] is placed in a region of uniform magnetic field $B = 2.0$ T. The magnetic field is perpendicular to the plane of the loop. **a)** Calculate the magnitude of the magnetic flux through the area of the circle. **b)** The loop is rotated by 180° during a time interval $\Delta t = 0.5$ s. Find the (average) EMF induced in the wire loop. **c)** The wire loop has resistance $R = 0.1 \Omega$. Find the energy dissipated in the wire. Where does this energy come from?

Solution: We have for the area $A = \pi r^2 = \pi(5.0 \times 10^{-2} \text{ m})^2 = 7.9 \times 10^{-3} \text{ m}^2$ so that for the magnetic flux $|\Phi| = BA = 2.0 \text{ T} \cdot 7.9 \times 10^{-3} \text{ m}^2 = 1.6 \times 10^{-2} \text{ T} \cdot \text{m}^2$. The change in the magnetic flux follows $\Delta\Phi = 2BA$ and for the induced EMF:

$$EMF = \frac{\Delta\Phi}{\Delta t} = \frac{2 \cdot 1.6 \times 10^{-2} \text{ T} \cdot \text{m}^2}{0.5 \text{ s}} = 6.4 \times 10^{-2} \text{ V}.$$

We have for the power $P = V^2/R$ so that

$$P = \frac{(6.4 \times 10^{-2} \text{ V})^2}{0.1 \Omega} = 4.1 \times 10^{-2} \text{ W}.$$

The dissipated energy [‘heat’] Q follows

$$Q = P\Delta t = 4.1 \times 10^{-2} \text{ W} \cdot 0.5 \text{ s} = 2.1 \times 10^{-2} \text{ J}.$$

This energy is supplied by *us* as we twirl the loop!

This result implies that increasing the current through a circuit *induces* [“produces”] an electromotive force that opposes this change in current:

$$\mathcal{E} = -L \frac{\Delta I}{\Delta t}. \tag{78}$$

Here, the coefficient is the (self-) inductance with unit $[L] = \text{Vs/A} = \text{H}$, or Henry. The self inductance is (somewhat) analogous to mass, i.e., it describes the ‘resistance’ to change: resistance to a change in velocity for mass and a resistance to change in current for inductors. That is, the inductance is analogous to mass $L \sim m$ and the current is analogous to velocity $I \sim v$. When the velocity of an object changes, the force (the agent of change) does work on the object, which is stored as the kinetic energy. For inductors, the battery (the agent of change) does work on the inductor, which is stored in the form of magnetic energy.

$$U_B = \frac{1}{2}LI^2 = \frac{1}{2}L \left(\frac{\Delta Q}{\Delta t} \right)^2. \quad (79)$$

The magnetic energy density follows

$$\frac{U_B}{\text{Volume}} = \frac{1}{2\mu_0} B^2.$$

That is, both electric and magnetic fields are associated with energy densities.



Empowering People. Improving Business.

BI Norwegian Business School is one of Europe's largest business schools welcoming more than 20,000 students. Our programmes provide a stimulating and multi-cultural learning environment with an international outlook ultimately providing students with professional skills to meet the increasing needs of businesses.

BI offers four different two-year, full-time Master of Science (MSc) programmes that are taught entirely in English and have been designed to provide professional skills to meet the increasing need of businesses. The MSc programmes provide a stimulating and multi-cultural learning environment to give you the best platform to launch into your career.

- MSc in Business
- MSc in Financial Economics
- MSc in Strategic Marketing Management
- MSc in Leadership and Organisational Psychology

BI NORWEGIAN BUSINESS SCHOOL

EFMD **EQUIS ACCREDITED**

www.bi.edu/master

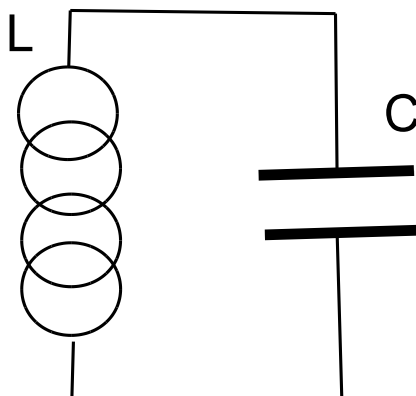

Example 6: A capacitor with $C = 4.6\text{ nF}$ is connected to an inductance with $L = 3.2\text{ mH}$. **a)** Show that the charge (and thus the current) in the circuit exhibits oscillatory time dependence. **b)** Determine the period of oscillation. **c)** If the capacitor is fully charged at time $t = 0$ with $Q_0 = 1.3\text{ pC}$, find the maximum value of the current in the circuit.

Solution: Since the current is equal to the flow of charges, we write the total energy of the system [capacitor and inductor] as

$$E_{\text{total}} = \frac{1}{2}L \left(\frac{\Delta Q}{\Delta t} \right)^2 + \frac{1}{2C}Q^2.$$

This is analogous to the expression for the energy of the spring-block system: $E_{\text{total}} = \frac{1}{2}m(\Delta x/\Delta t)^2 + \frac{1}{2}kx^2$, where we used $v = \Delta x/\Delta t$ for the velocity of the mass m . We thus have $m \sim L$ and $k \sim 1/C$. The period of the spring-block system is given by $T = 2\pi\sqrt{m/k}$ so that for the period of the oscillatory time-dependence in the electric circuit:

$$T = 2\pi\sqrt{LC} = 2\pi\sqrt{3.2 \times 10^{-3}\text{ H} \cdot 4.6 \times 10^{-9}\text{ F}} = 2.4 \times 10^{-5}\text{ s},$$

and the frequency is $f = 1/T = 41.5\text{ kHz}$. We have the maximum charge on the capacitor at time $t = 0$: $Q_{\text{max}} = Q_0$; this is analogous to the amplitude of the motion of the block. The maximum current through the circuit is established after a quarter period, i.e., $t = T/4 = 0.6\text{ ms}$:

$$I_{\text{max}} = \omega Q_{\text{max}} = \frac{2\pi}{T}Q_{\text{max}} = \frac{2\pi}{2.4 \times 10^{-6}\text{ s}} \cdot 1.3 \times 10^{-12}\text{ C} = 3.4 \times 10^{-6}\text{ A}.$$

Discussion: This relationship between the (maximum) charge and current is analogous to the relationship between amplitude and maximum speed.

The force on a charge in magnetic field depends on its velocity, $F = qvB$. This behavior is curious, since it different observers moving at different velocities would measure different velocities of the charges, and thus find different Lorentz forces acting on the charge. Such a dependence on the velocity of the *observer* would be in violation of Newton's first law [or, *Galilean invariance*].

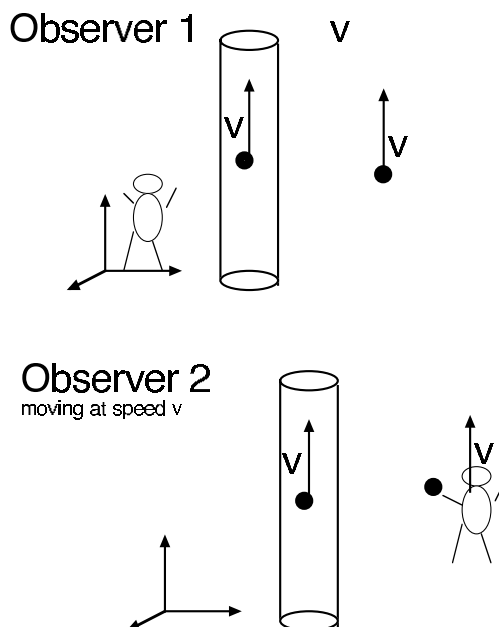

Consider two particles moving parallel to each other at constant speed.

Observer 1: at rest. Charged particle 1 [current] produces magnetic field B , the particle 2 feels the magnetic force $F_m = qvB$.

Observer 2: moving with particles. Particle 1 is now at rest, and thus produces an electric field E , the other particle 2 then feels the electric force $F_e = qE$. (Note that particle labelling 1 and 2 can be switched).

We conclude that different observers describe different situation: this violates a fundamental principle of physics. This shows that electric and magnetic phenomena are related to each other at a fundamental level. In many instances, magnetic fields are much weaker than electric fields – this is the case at small speeds. When charges [or objects] move at the speeds close to the speed of light: $v \sim c$, electric and magnetic fields have the same strength. This case is covered in Einstein's *Special Theory of Relativity* – “Zur Elektrodynamik bewegter Körper,” or “Electrodynamics of moving bodies,” *Annalen der Physik* 1905.

16 Electromagnetic Waves

The phenomena of motional EMF shows that a time-dependent magnetic field produces an electric field. James C. Maxwell proposed that a time-dependent electric field similarly produces a magnetic field. Thus, time-dependent electric and magnetic fields are intrinsically coupled to each other. The speed of a transverse elastic wave can be found by setting the kinetic and elastic potential energy equal to each other. The same idea can be applied to electric and magnetic fields: we set $U_E/V = U_B/V$, or $\epsilon_0 E^2/2 = B^2/2\mu_0$, so that

$$B = \sqrt{\epsilon_0\mu_0}E. \quad (1)$$

The physical meaning becomes transparent when we compare electric and magnetic forces: $F_E = qE$ and $F_B = qvB$ so that $F_E = F_B$ gives $B = E/v$. It follows that the combination $1/\sqrt{\epsilon_0\mu_0}$ is a speed:

$$c = \frac{1}{\sqrt{\epsilon_0\mu_0}} = \frac{1}{\sqrt{8.85 \times 10^{-12} \text{ C}^2/(\text{Nm}^2) \cdot 4\pi \times 10^{-7} \text{ Tm/A}}} = 3 \times 10^8 \frac{\text{m}}{\text{s}}. \quad (2)$$

Need help with your dissertation?

Get in-depth feedback & advice from experts in your topic area. Find out what you can do to improve the quality of your dissertation!

Get Help Now



Go to www.helpmyassignment.co.uk for more info



Helpmyassignment



Click on the ad to read more

This is the universal speed of light in vacuum, and establishes light as an electromagnetic phenomena. The frequency and wavelength are related,

$$c = \lambda f, \quad (3)$$

i.e., long wavelengths correspond to small frequencies and vice versa. For purely historical reasons, electromagnetic waves at different wavelengths (or frequencies) have different names:

Name	λ [m]	f [Hz]
Radio	$10^3 - 10^{-1}$	$10^3 - 10^9$
Microwave	$10^{-1} - 10^{-4}$	$10^9 - 10^{12}$
Infrared	$10^{-2} - 10^{-8}$	$10^{12} - 10^{14}$
Visible light	$7.5 \times 10^{-7} - 3.8 \times 10^{-7}$	$4.0 \times 10^{14} - 7.9 \times 10^{14}$
Ultraviolet	$10^{-8} - 10^{-9}$	$10^{15} - 10^{17}$
X-ray	$10^{-9} - 10^{-12}$	$10^{17} - 10^{20}$
Gamma rays	$10^{-12} - 10^{-16}$	$10^{20} - 10^{24}$

The spectrum of visible light is very narrow and ranges from red [long wavelength] to violet [short wavelength].

Wave phenomena are associated with transport of energy and momentum. The transport of momentum by electromagnetic waves is referred to as *radiation pressure*. Since the energy densities of the electric and magnetic fields are given by $u_E = \epsilon_0 E^2/2$ and $u_B = B^2/(2\mu_0)$, the intensity [power divided by area] follows

$$S = cu = \frac{P}{A} = c\epsilon_0 E^2 = \frac{c}{\mu_0^2} B^2. \quad (4)$$

Example 1: A 20-ounce [0.59 liter] coffee cup is heated for 3 minutes in a microwave oven. Coffee can be treated as water; use $\rho = 1000 \text{ kg/m}^3$ for the density and $c = 4186 \text{ J/(kg} \cdot ^\circ\text{C)}$ for the specific heat of water. **a)** The temperature raises from $T_i = 20^\circ\text{C}$ to $T_f = 52^\circ\text{C}$. Ignore vaporization of water. What is the power delivered to the water inside the cup? **b)** The cup is (approximately) cylindrical shape with diameter 9.0 cm and height 14.0 cm. Assume that radiation enters the cup through the top and the curved side of the cup [but not the bottom]. Assume for simplicity that the rays are perpendicular (normal) the surfaces. Find the intensity of the electromagnetic wave inside the microwave oven. **c)** Find the strength of the electric field produced by the microwave oven!

Solution: We have for the mass of water $m = 0.59 \text{ kg}$. We then have for the energy: $Q = mc\Delta T = 0.59 \text{ kg} \cdot 4186 \text{ J/(kg} \cdot ^\circ\text{C)} \cdot 32^\circ\text{C} = 7.9 \times 10^4 \text{ J}$, and thus for the power:

$$P = \frac{Q}{t} = \frac{7.9 \times 10^4 \text{ J}}{180 \text{ s}} = 440 \text{ W}.$$

We have for the surface area:

$$A = \pi \cdot (4.5 \times 10^{-2} \text{ m})^2 + 2\pi \cdot 4.5 \times 10^{-2} \text{ m} \cdot 1.4 \times 10^{-1} \text{ m} = 4.6 \times 10^{-2} \text{ m}^2.$$

Thus the intensity is

$$S = \frac{P}{A} = \frac{440 \text{ W}}{4.6 \times 10^{-2} \text{ m}^2} = 9.6 \times 10^3 \frac{\text{W}}{\text{m}^2}.$$

We have $S = cu$ so that for the energy density

$$u = \frac{S}{c} = \frac{9.6 \times 10^3 \text{ W/m}^2}{3.0 \times 10^8 \text{ m/s}} = 3.2 \times 10^{-5} \frac{\text{J}}{\text{m}^3}.$$

Since $u = \epsilon_0 E^2$ so that for the electric field:

$$E = \sqrt{\frac{u}{\epsilon_0}} = \sqrt{\frac{3.2 \times 10^{-5} \text{ J/m}^3}{8.85 \times 10^{-12} \text{ C}^2/(\text{N m}^2)}} = 1.9 \times 10^3 \frac{\text{N}}{\text{C}}.$$

Discussion: The solar constant is 1.4 kW/m^2 . The calculation is somewhat misleading since the electric field distribution is highly non-uniform; the electric field is much higher in some spots close to the coils in which the EM wave is produced. When the microwave oven is closed, most of the radiation is shielded from the outside.

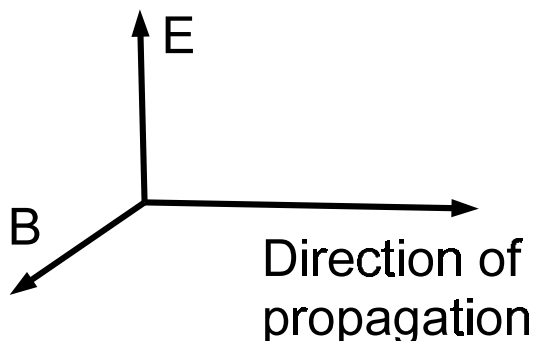

The electric and magnetic fields in an electromagnetic field are perpendicular to each other and the direction of propagation. If we choose the z -axis along the direction of propagation, then the electric field is described by a vector in the xy -plane: $\vec{E} = E_x \hat{i} + E_y \hat{j}$. This direction is referred to as the polarization of the light. Sunlight has no particular polarization, and thus is said to be *unpolarized*. Instead of specifying the electric field in terms of two components in perpendicular directions, light can also be described in terms of right- and left-handed circularly polarized light.

Example 2: A linear polarizer is used to produce linearly polarized light with intensity I_0 . A second linear polarizer is used to diminish the intensity to $I = I_0/3$. Find the angle between the two polarizers?

Solution: We choose the x -axis along the direction of the first polarizer. If θ is the angle between the two polarizers, the electric field after the second polarizer follows: $E = E_0 \cos \theta$. Since the intensity of light is proportional to the square of the electric field:

$$\frac{I}{I_0} = \frac{1}{3} = \cos^2 \theta \quad \rightarrow \quad \theta = \cos^{-1} \left(\frac{1}{\sqrt{3}} \right) = 54.7^\circ.$$

Blue sky is produced by the interaction of sun light with air molecules with diameter $D \sim 10^{-8}$, m. For light in the visible part of the spectrum, the wavelength is of the same order as the size of air molecules $\lambda \sim D$, in which case the intensity of scattered light depends on the frequency $I \sim f^4$ [so called Rayleigh scattering]. It follows that blue scatters more strongly than red. In principle, violet light is scattered even more strongly, however, human eyes are less sensitive to violet than they are to blue. Clouds are made of small ice crystals with diameters $D \simeq 1$ mm so that the wavelength is much smaller than the typical size $\lambda < D$. Therefore, all colors are scattered independent of the frequency $I \sim f^0$. This means that clouds reflect light independent of color so that clouds appear white.

The speed of light depends on the material: index of refraction n :

$$n = \frac{\text{speed of light in vacuum}}{\text{speed of light in material}} = \frac{c}{v} > 1.$$

For diamond $n = 2.419$; the index of refraction depends on the wavelength.



Brain power

By 2020, wind could provide one-tenth of our planet's electricity needs. Already today, SKF's innovative know-how is crucial to running a large proportion of the world's wind turbines.

Up to 25 % of the generating costs relate to maintenance. These can be reduced dramatically thanks to our systems for on-line condition monitoring and automatic lubrication. We help make it more economical to create cleaner, cheaper energy out of thin air.

By sharing our experience, expertise, and creativity, industries can boost performance beyond expectations. Therefore we need the best employees who can meet this challenge!

The Power of Knowledge Engineering

Plug into The Power of Knowledge Engineering.
Visit us at www.skf.com/knowledge

SKF

17 Geometric Optics

We use D for the ‘typical’ length of objects [opening, size of lenses, etc]. When this length is much bigger than the wavelength of light $D \gg \lambda$, the wave phenomena of light [interference and diffraction] disappear, and the propagation of light can be described by Huygen’s principle. The direction perpendicular to wave fronts define rays.

Geometric optics goes back to studies of Euclid and Al-Kindi who proposed that ‘everything in the world...emits rays in every direction, which fill the whole world’ [See, P. Adamson, *Al-Kindi – Great Medieval Thinkers Series* (Oxford University Press, New York, 2007)].

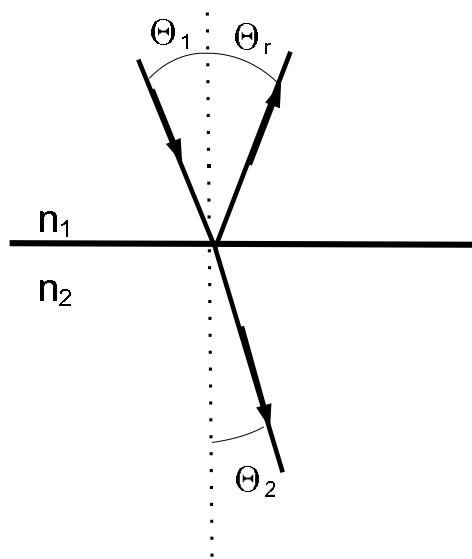

An interface exists between two media with different index of refraction $n_1 < n_2$. When incident ray at the angle θ_1 with respect to the normal strikes the interface, light is partially reflected at the angle $\theta_r = \theta_1$ and partially refracted at the angle $\theta_2 < \theta_1$, i.e., the ray is refracted towards the normal. In the case $n_1 > n_2$, one finds $\theta_2 > \theta_1$, i.e., the ray is refracted away from the normal.

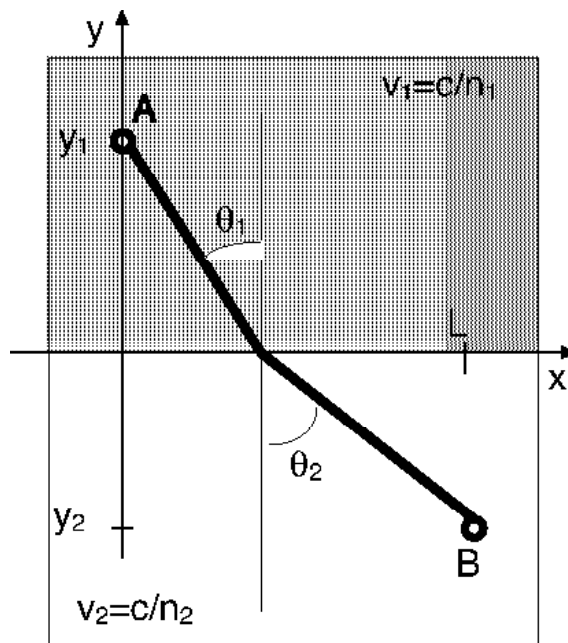

The phenomena of reflection and refraction can be explained by *Fermat's principle*; it states that the path taken by light in traveling from one point to another is such that the time of travel is a minimum. Fermat's principle can be used to qualitatively explain mirages and sunsets. Dispersion of light follows from the frequency dependence of the index of refraction $n = n(f)$: violet is bent more than red [*rainbow!*].

Fermat Principle

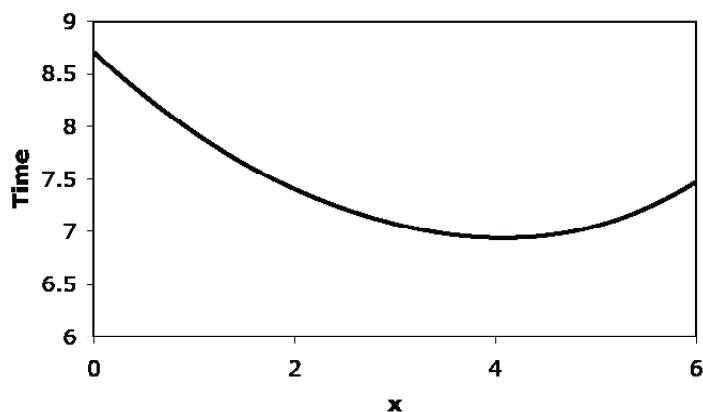

We assume that $n_1 > n_2$ so that $v_1 < v_2$. In this case, the straight path from A to B does not correspond to the shortest time. Rather, as shorter time can be found by shortening the path from A to the interface and thus lengthening the path from the interface to B. That is, the condition of shortest time between A and B produces the bending of the path away from the normal, just as in the case of refraction.

Snell's law describes the 'bending' of light at the interface between two materials with index of refraction

n_1 and n_2 , respectively,

$$n_1 \sin \theta_1 = n_2 \sin \theta_2. \quad (5)$$

When light enters from air into water $n_1 < n_2$, we find $\theta_1 > \theta_2$, and light rays bend towards the normal direction. When light enters from water into air, rays bend away from the normal direction. In the case $n_1 > n_2$ the maximum angle is $\theta_{2,\max} = 90^\circ$ so that $\sin \theta_{2,\max} = 1$. This happens when $n_1 \sin \theta_{i,\max} = n_2$, so that

$$\sin \theta_{i,\max} = \frac{n_2}{n_1}. \quad (\text{total internal reflection}). \quad (6)$$

We now use two extreme cases: (1) when all light rays are reflected (mirrors) and (2) when all light rays are refracted (lenses).

What do you want to do?

No matter what you want out of your future career, an employer with a broad range of operations in a load of countries will always be the ticket. Working within the Volvo Group means more than 100,000 friends and colleagues in more than 185 countries all over the world. We offer graduates great career opportunities – check out the Career section at our web site www.volvogroup.com. We look forward to getting to know you!

VOLVO
 AB Volvo (publ)
www.volvogroup.com

VOLVO TRUCKS | RENAULT TRUCKS | MACK TRUCKS | VOLVO BUSES | VOLVO CONSTRUCTION EQUIPMENT | VOLVO PENTA | VOLVO AERO | VOLVO IT
 VOLVO FINANCIAL SERVICES | VOLVO 3P | VOLVO POWERTRAIN | VOLVO PARTS | VOLVO TECHNOLOGY | VOLVO LOGISTICS | BUSINESS AREA ASIA



Example 3: A light ray travels from oil into water [refractive index 1.33]. The angle of incident ray is $\theta_i = 34^\circ$ and the angle of the refracted ray is $\theta_r = 38^\circ$. **a)** What is the index of refraction of the oil? **b)** What is the angle of the incident ray such that the entire ray is internally reflected at the interface? **c)** Water is replaced by ethyl alcohol [$n = 1.36$]. Does a refracted ray enter the alcohol if the incident ray is kept at the same angle as in part **b)**? If it does, calculate the angle of the refracted ray!

Solution: We have $\theta_1 = 34^\circ$, $\theta_2 = 38^\circ$, and $n_2 = 1.33$. Then for the index of refraction,

$$n_1 = n_2 \frac{\sin \theta_2}{\sin \theta_1} = 1.33 \cdot \frac{\sin 38^\circ}{\sin 34^\circ} = 1.46.$$

We have $\theta_2 = 90^\circ$ so that $n_1 \sin \theta'_1 = n_2$, and the angle of incident ray

$$\theta'_1 = \sin^{-1} \left(\frac{n_2}{n_1} \right) = \sin^{-1} \left(\frac{1.33}{1.46} \right) = 65.6^\circ.$$

Refracted ray enters alcohol. We use $n'_2 = 1.36$ so that $n_1 \sin \theta'_1 = n'_2 \sin \theta'_2$, and

$$\sin \theta'_2 = \frac{n_1}{n'_2} \sin \theta'_1 = \frac{n_1}{n'_2} \cdot \frac{n_2}{n_1} = \frac{n_2}{n'_2} = \frac{1.33}{1.36} = 0.98.$$

We find the angle of the refracted ray.

$$\theta'_2 = \sin^{-1} \left(\frac{1.33}{1.36} \right) = 77.9^\circ.$$

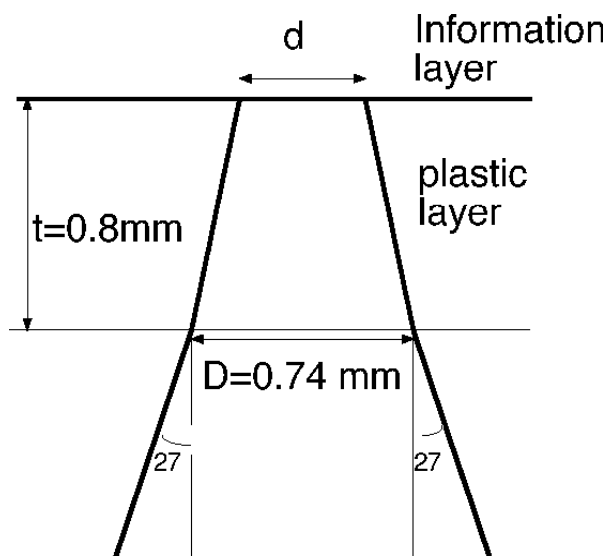

Example 4: A light ray propagating in air strikes a layer of plastic with refractive index $n = 1.55$. **a)** If the incident angle is $\theta_1 = 27^\circ$, what is the angle of the refracted ray? **b)** The laser beam that “reads” information from a compact disc is 0.74 mm when it strikes the disc, and it forms a cone with half-angle $\theta_1 = 27^\circ$, as shown. It passes through a 0.8 mm -thick layer of plastic before reaching the reflective information layer near the disc’s top surface. What is the beam diameter d at the information layer? **c)** The bits in the information layer have the size $d = 1.8 \mu\text{m}$. How thick should the plastic layer be?

Solution: We have Snell’s law $n_1 \sin \theta_1 = n_2 \sin \theta_2$ with $n_1 = 1$ and $n_2 = 1.55$ so that

$$\sin \theta_2 = \frac{n_1}{n_2} \sin \theta_1 = \frac{1}{1.55} \sin 27^\circ = 0.293 \quad \rightarrow \quad \theta_2 = 17^\circ.$$

From the graph, we read: $d = D - 2t \cdot \tan \theta_2$ so that

$$d = 0.74 \text{ mm} - 2 \cdot 0.8 \text{ mm} \cdot \tan 17^\circ = 0.25 \text{ mm}.$$

We have $d = D - 2t \cdot \tan \theta_2$ and solve for the thickness:

$$t = \frac{D - d}{2 \tan \theta_2} = \frac{7.4 \times 10^{-4} \text{ m} - 1.8 \times 10^{-6} \text{ m}}{2 \cdot \tan 17^\circ} = 1.2 \text{ mm}.$$

17.1 Mirrors

We distinguish between plane and spherical mirrors.

17.1.1 Plane Mirror

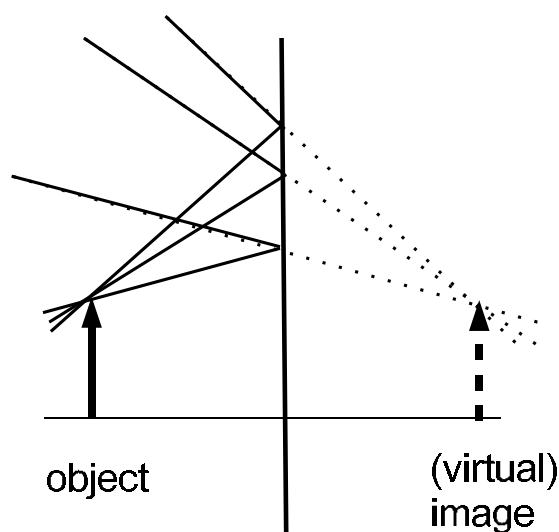

We have (upright) object in front of the plane mirror; the object distance is positive $d_o > 0$. All incident rays are reflected by the mirror: the reflected rays diverge: the reflected rays are continued backwards behind the mirror. The continuation of the reflected rays intersect so that they appear to originate from a point behind the mirror. This is the (virtual) image of the object. We use the convention that the image distance of a virtual image is negative: $d_i = -d_o < 0$. The height of the object and image are equal $h_o = h_i$, we say that the magnification of a plane mirror is unity:

$$m = \frac{h_i}{h_o} = 1. \quad (7)$$

17.1.2 Spherical Mirror

We consider spherical mirrors, i.e., mirror with the shape of a sphere with radius R . We consider objects close the line through the center of the sphere: *principal axis*. When the object is (infinitely) far away, the incoming rays are parallel to the principal axis.

gaiTeye
Challenge the way we run

EXPERIENCE THE POWER OF FULL ENGAGEMENT...

**RUN FASTER.
RUN LONGER..
RUN EASIER...**

**READ MORE & PRE-ORDER TODAY
WWW.GAITEYE.COM**

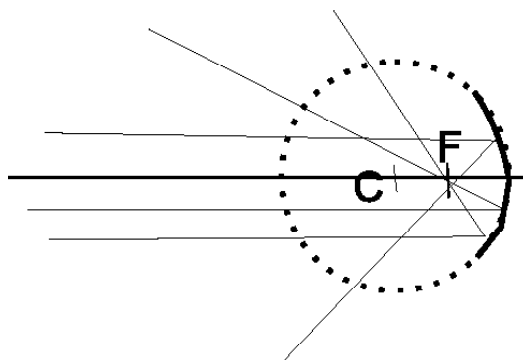

For a *concave* mirror, the reflected rays intersect at a point in front of the mirror; if a screen is placed at that location, a clear image of the object is seen on the screen [similar to a picture on the screen of a movie theater]. We say the image is *real*. If the object is (infinitely) far away the location of the image is at the *focal point* in front of the mirror. The distance between focal point and the mirror is the focal length:

$$f = \frac{R}{2} > 0. \quad (8)$$

The object distance d_o and the image distance d_i is related by the *mirror equation*:

$$\frac{1}{d_o} + \frac{1}{d_i} = \frac{1}{f}. \quad (9)$$

The image is inverted, or upside down, so that $h_i < 0$. The magnification is given by

$$m = \frac{h_i}{h_o} = -\frac{d_i}{d_o}. \quad (10)$$

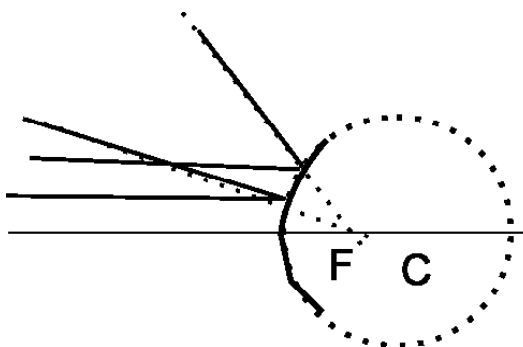

For a *convex* mirror, the reflected rays diverge; however, if the reflected rays are continued backwards they intersect at a point. We say the image is *virtual*. If the object is (infinitely) far away the location of the image is at the *focal point* behind the mirror. The distance between focal point and the mirror is the focal length:

$$f = -\frac{R}{2} < 0. \quad (11)$$

The object distance d_o and the image distance d_i is related by the *mirror equation*:

$$\frac{1}{d_o} + \frac{1}{d_i} = \frac{1}{f}. \quad (12)$$

The image is inverted, or upside down, so that $h_i < 0$. The magnification is given by

$$m = \frac{h_i}{h_o} = -\frac{d_i}{d_o}. \quad (13)$$

Example 5: We want to produce an image enlarged 2.5 times and inverted at the distance $\Delta = 10$ cm from the object. What mirror do you use and where do you place the mirror?

Solution: Since the image is inverted, we know that the image is real. Since $m = -2.5 = -d_i/d_o$, we get $d_i = 2.5d_o$ the image is further away from the mirror than object so that

$$\Delta = 10 \text{ cm} = d_i - d_o = 2.5d_o - d_o = 1.5d_o \quad \longrightarrow \quad d_o = \frac{1}{1.5} 10 \text{ cm} = 6.7 \text{ cm}.$$

and

$$d_i = \frac{2.5}{1.5} \cdot 10 \text{ cm} = 16.7 \text{ cm}.$$

We then get for the focal length:

$$\frac{1}{f} = \frac{1}{6.7 \text{ cm}} + \frac{1}{16.7 \text{ cm}} = \frac{1}{4.8 \text{ cm}} \quad \longrightarrow \quad f = 4.8 \text{ cm};$$

i.e., we use a concave mirror.

The mirror equation can be solved by geometric means. We draw three distinct rays:

1. incoming ray parallel to the principal axis – reflected through the focal point F
2. incoming ray through the focal point F – reflected ray parallel to the principal axis
3. incoming ray through the center C of the sphere – reflected onto itself.

All problems from geometric optics can be solved using only a ruler and compass.

Example 6: The virtual image of height $h_i = 4.0$ cm is produced by a concave mirror with $R = 10.0$ cm is 3.0 cm *behind* the mirror. **b)** Verify the results from your drawing by using appropriate equations. **c)** Where do you have to place the object so that the image is magnified three times?

Solution: Draw the ray diagram that is appropriate for finding the image! What is the object distance and the magnification?

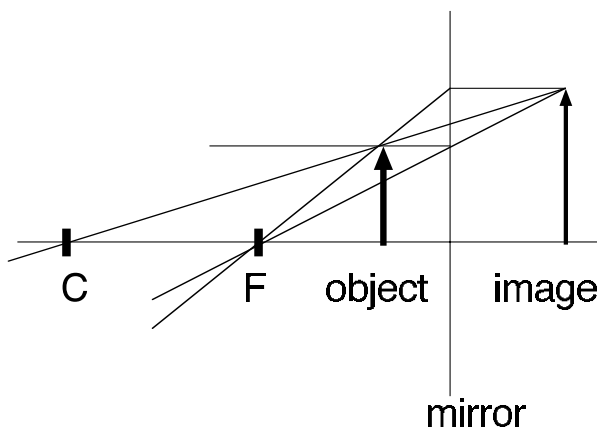

We read off $d_o = 1.6 \text{ cm}$ and $h_o = 2.4 \text{ cm}$. The magnification follows

$$m = \frac{h_i}{h_o} = \frac{4.0 \text{ cm}}{2.4 \text{ cm}} = 1.7.$$

We have $f = 5.0 \text{ cm}$. Then

$$\frac{1}{d} = \frac{1}{f} - \frac{1}{d_i} = \frac{1}{5.0 \text{ cm}} - \frac{1}{(-3.0 \text{ cm})} = \frac{1}{1.9 \text{ cm}} \quad \rightarrow \quad d_o = 1.9 \text{ cm}.$$

This e-book
is made with
SetaPDF



SETASIGN



PDF components for PHP developers

www.setasign.com



The magnification follows,

$$m = -\frac{d_i}{d_o} = -\frac{-3.0 \text{ cm}}{1.9 \text{ cm}} = 1.6.$$

The object height follows,

$$h_o = \frac{h_i}{m} = \frac{4.0 \text{ cm}}{1.6} = 2.5 \text{ cm}.$$

We have $m' = -d_i/d_o$ so that $d_i = -3d_o$. Then

$$\frac{1}{f} = \frac{1}{d_o} + \frac{1}{d_i} = \frac{1}{d_o} + \frac{1}{(-3d_o)} = \frac{2}{3d_o} \quad \rightarrow \quad d_o = \frac{2f}{3} = \frac{2}{3} \cdot 5 \text{ cm} = 3.3 \text{ cm}.$$

The object must be placed 3.3 cm in front of the mirror.

Discussion: Generally, drawings can be used to find results that are quite accurate.

17.2 Lenses

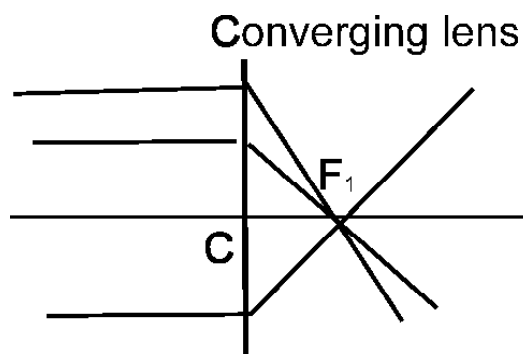

The incoming rays of an object (infinitely) far away are refracted in a *converging* lens such that they intersect at the focal point F_1 : the distance between the center of the lens and the focal point is the focal length f . The focal point F_1 is behind the lens and we use the convention

$$f > 0 \quad (\text{converging lens}). \quad (14)$$

Because the refracted rays intersect, it follows that a converging lens produces a real image of an object that is sufficiently far away.

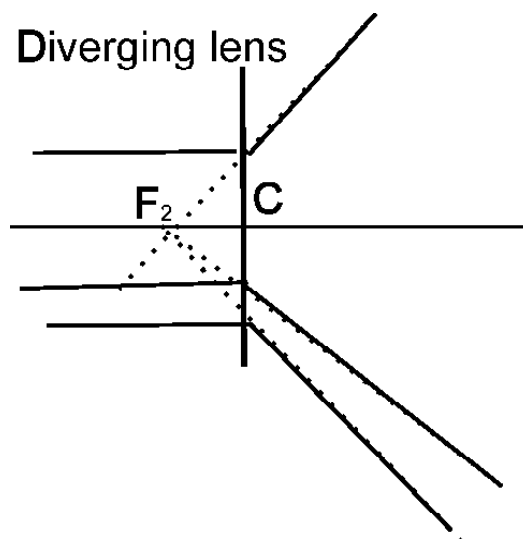

The incoming rays of an object (infinitely) far away are refracted in a *diverging* lens such that they diverge: their continuation backwards intersect at the focal point F_2 : the distance between the center of the lens and the focal point is the focal length f . The focal point F_2 is in front of the lens and we use the convention

$$f < 0 \quad (\text{diverging lens}). \quad (15)$$

Because the refracted rays diverge, a diverging lens always produces a virtual image.

The “power” of a lens is often measured in *diopters*. If the focal length is measured in meters $[f] = \text{m}$, then

$$\text{Diopter} = \frac{1}{f}. \quad (16)$$

In general, the object is at the distance $d_o > 0$ from the lens, so that the image is at the distance d_i . We use the convention that $d_i > 0$ if the image is behind the lens [and thus real], and $d_i < 0$, if the image is in front of the lens [and thus is virtual]. The object and image distance are related by the lens equation:

$$\frac{1}{d_o} + \frac{1}{d_i} = \frac{1}{f}. \quad (17)$$

We use $h_o > 0$ for the object height and h_i for the image height: we have $h_i > 0$ if the object is upright [and virtual] and $h_i < 0$ if the image is inverted [and real]. The magnification is given by

$$m = \frac{h_i}{h_o} = -\frac{d_i}{d_o}. \quad (18)$$

We note that the mirror and lens equations are (formally) identical. We summarize the image properties in a table:

Lens	d_o	d_i	Image	Property
Converging	$f > 0$	$d_o > f$	$d_i > 0$	real
Converging	$f > 0$	$d_o < f$	$d_i < 0$	virtual
Diverging	$f < 0$	$d_o > 0$	$d_i < 0$	virtual

In a system with two [or more] lenses, the image produced by the first lens is the object for the second lens. For a microscope, the first lens is called the “objective” and the second lens is called the “eyepiece.”

Example 7: A student is trying to complete her report for the experiments with lenses. As usual, she talked too much during the lab and her record is incomplete: she forgot to write down the type and focal lengths of the lenses she used in the experiment. Her record for the images, the position x along the principal axis, and the image heights h reads:

	real/imaginary	x [cm]	h [cm]
object	n/a	0	4.0
intermediate	real	7.0	-2.0
final	real	18.0	5.0

www.sylvania.com

We do not reinvent the wheel we reinvent light.

Fascinating lighting offers an infinite spectrum of possibilities: Innovative technologies and new markets provide both opportunities and challenges. An environment in which your expertise is in high demand. Enjoy the supportive working atmosphere within our global group and benefit from international career paths. Implement sustainable ideas in close cooperation with other specialists and contribute to influencing our future. Come and join us in reinventing light every day.

Light is OSRAM

OSRAM SYLVANIA



a) Draw the ray diagram for the problem. **b)** Use the ray diagram to find the focal lengths of the two lenses! What is the distance between the two lenses? What are the object and images distances. **c)** The student did not finish the second part of the lab, where she was supposed to move the object one centimeter further to the left, while leaving the two lenses unchanged. Find the location of the intermediate and final image along the principal axis.

Solution:

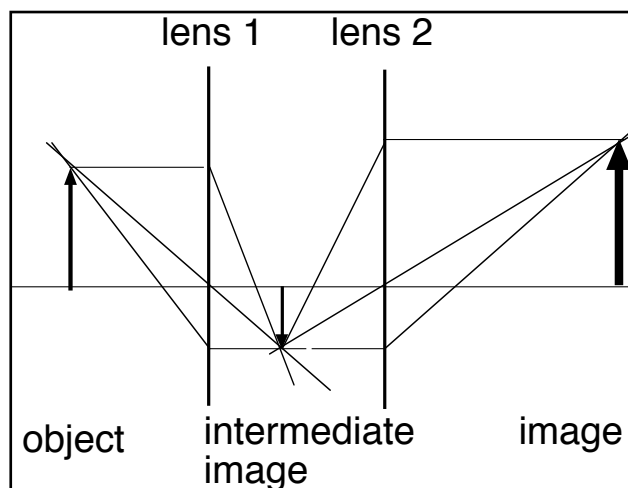

Both lenses are *converging*. The focal lengths are

$$\text{lens 1 : } f_1 = \frac{14}{9} \text{ cm} = 1.56 \text{ cm} \quad \text{lens 2 : } f = \frac{110}{44} \text{ cm} = 2.5 \text{ cm}.$$

The distance between the two lenses is $D = (115/21) \text{ cm} = 5.5 \text{ cm}$.

The object distance is $d_o = (14/3) \text{ cm} = 4.67 \text{ cm}$ and the (final) image distance is $d'_i = 7.4 \text{ cm}$. We have $d_{o,2} = 4.6 \text{ cm} + 1.0 \text{ cm} = 5.6 \text{ cm}$ so that

$$\frac{1}{d'_i} = \frac{1}{1.6 \text{ cm}} - \frac{1}{5.6 \text{ cm}} = \frac{1}{2.2 \text{ cm}} \quad \longrightarrow \quad d'_i = 2.2 \text{ cm}.$$

It follows that the object distance of the intermediate image is $d'_{o,2} = 5.5 \text{ cm} - 2.2 \text{ cm} = 3.4 \text{ cm}$;

$$\frac{1}{d'_{i,2}} = \frac{1}{f_2} - \frac{1}{d'_{o,2}} = \frac{1}{2.5 \text{ cm}} - \frac{1}{3.3 \text{ cm}} = \frac{1}{10.3 \text{ cm}} \quad \longrightarrow \quad d'_{i,2} = 10.3 \text{ cm}.$$

We get for the positions along the principal axis with $x_{\text{object}} = 0$ [*my choice!*]

$$x_{\text{intermediate}} = 5.6 \text{ cm} + 2.2 \text{ cm} = 7.8 \text{ cm},$$

$$x_{\text{image}} = 5.6 \text{ cm} + 5.5 \text{ cm} + 10.3 \text{ cm} = 21.4 \text{ cm}.$$

The human eye is a converging lens which produces a *real* image on the retina. The distance between lens and retina is fixed. The eye can produce sharp images for a range of object distances by changing the focal length of the lens. Normal or 20/20 vision is defined by this range:

$$25 \text{ cm (near point)} < d_o < \infty \text{ (far point)}. \quad (19)$$

Example 8: Calculate the range of power of the human lens for a person with 20/20 vision.

Solution: Person looks at an object far away: we have $d_o = \infty$ and $d_i = 1.8 \text{ cm}$, then

$$\frac{1}{f} = \frac{1}{\infty} + \frac{1}{0.018 \text{ m}} = 55.6 \text{ diopters},$$

and when the person reads a book: $d_o = 25 \text{ cm}$ and $d_i = 1.8 \text{ cm}$, then

$$\frac{1}{f} = \frac{1}{0.25 \text{ m}} + \frac{1}{0.018 \text{ m}} = 59.6 \text{ diopters}.$$

Discussion: This adaptation is done by ‘tensing’ the muscles attached to the lens.

The two most common vision problems are nearsightedness (myopia) and farsightedness (hyperopia). For myopia, the far point is not infinitely far away, but rather is at a finite distance. The person wears a diverging lens such that the eyeglass produces a (virtual and thus upright) image at the person’s nearpoint of the object that is infinitely far away. For hyperopia, the near point is farther away than the comfortable reading distance [i.e., 25 cm]. The person wears eyeglasses with a converging lens, and the book is placed inside the focal length of the eyeglass: a (virtual and thus upright) image is produced at the person’s near point.

Example 9: A person uses eyeglasses to read the paper. She wears her glasses 2.1 cm in front of her eyes. Her glasses have the prescription of +1.5 diopters. **a)** What is her nearpoint when she has no problem reading a paper sitting on her desk that is 27.0 cm in front of her eyes? **b)** She complains to her ophthalmologist that she has trouble reading text on the screen of her computer that is 20.0 cm in front of her eyes. Her doctor recommends that she uses bifocals. What is the prescription of the top-section of her bifocals? **c)** The letters on the computer screen are 2.5 mm tall. How tall do they appear to the person?

Solution: We have $f = 1/(1.5 \text{ m}^{-1}) = 66.7 \text{ cm}$, $d_o = 27.0 \text{ cm} - 2.1 \text{ cm} = 24.9 \text{ cm}$. Then

$$\frac{1}{d_i} = \frac{1}{f} - \frac{1}{d_o} = \frac{1}{66.7 \text{ cm}} - \frac{1}{24.9 \text{ cm}} = -\frac{1}{39.7 \text{ cm}}.$$

We thus have for the nearpoint: $39.7 \text{ cm} + 2.1 \text{ cm} = 41.8 \text{ cm}$ in front of her eyes. We have $d_o = 20.0 \text{ cm} - 2.1 \text{ cm} = 17.9 \text{ cm}$ and $d_i = -39.7 \text{ cm}$. Then

$$\frac{1}{f'} = \frac{1}{d_o} + \frac{1}{d_i} = \frac{1}{17.9 \text{ cm}} + \frac{1}{(-39.7 \text{ cm})} = \frac{1}{32.3 \text{ cm}}.$$

Thus, the prescription for the top part of her bifocals is

$$D = \frac{1}{f} = \frac{1}{0.32 \text{ m}} = +3.1.$$

We have the magnification $m = -d_i/d_o = -(-39.7 \text{ cm})/(17.9 \text{ cm}) = 2.2$ so that

$$h_i = mh_o = 2.2 \cdot 2.5 \text{ mm} = 5.2 \text{ mm}.$$



Discover the truth at www.deloitte.ca/careers

Deloitte.

© Deloitte & Touche LLP and affiliated entities.



Click on the ad to read more

18 Physical Optics

The wave nature of light is apparent when the width of the opening, or the distance between openings, is of the order of the wavelength. For example, if the opening is a door $D = 1$ m, the wavelength of visible light is much shorter $\lambda_{\text{light}} \ll D$, whereas the wavelength of sound is comparable to it $\lambda_{\text{sound}} \sim D$. This explains why we can easily hear the sound from room-to-room in a house, but we cannot see ‘around corners.’ The bending of light, similarly to the bending of sound waves, is measured by the angle away from the forward direction.

Diffraction refers to the “bending” of light through a single opening of width W . Bright and dark fringes are observed on a screen opposite to the opening. We have for the angles

$$\sin \theta = m \frac{\lambda}{W}, \quad m = 1, 2, 3, \dots \quad (20)$$

Here, m is an integer and is called the “order” of the minima. Diffraction determines the ‘resolving power’ of lenses and other optical instruments. In that case, we set $m = 1$; if the opening is circular, the above formula must be corrected by a numerical factor,

$$\sin \theta = 1.22 \frac{\lambda}{W} \quad (\text{resolving power}). \quad (21)$$

Example 1: At night, the pupils of a person are slightly enlarged to $D = 2.3$ mm. **a)** The wavelength of red light is 680 nm. What is the smallest crater on the Moon that is visible by the naked eye of an observer? [Use $L = 384,000$ km for the distance between the Earth and the Moon]. **b)** Engineers from NASA are asked to build a telescope such that craters as small as 200 m in diameter [that’s about the size of a football stadium] can be observed from the Earth. What is the diameter of the telescope such that it fulfills the design specification? Use red light with wavelength 680 nm.

Solution: The diffraction angle follows:

$$\theta_{\min} = 1.22 \frac{\lambda}{D} = 1.22 \frac{6.8 \times 10^{-7} \text{ m}}{2.3 \times 10^{-3} \text{ m}} = 3.6 \times 10^{-4}.$$

Thus the diameter d of the smallest visible crater follows $\theta_{\min} = d/L$,

$$d = L \theta_{\min} = 3.6 \times 10^{-4} \cdot 3.84 \times 10^5 \text{ km} \simeq 140 \text{ km}.$$

We now have for the diffraction angle:

$$\theta_{\min} = \frac{d}{L} = \frac{0.2 \text{ km}}{384,000 \text{ km}} = 5.2 \times 10^{-7}.$$

We thus get for the diameter of the radiotelescope:

$$D = 1.22 \frac{\lambda}{\theta_{\min}} = 1.22 \frac{6.8 \times 10^{-7} \text{ m}}{5.2 \times 10^{-7}} = 1.6 \text{ m}.$$

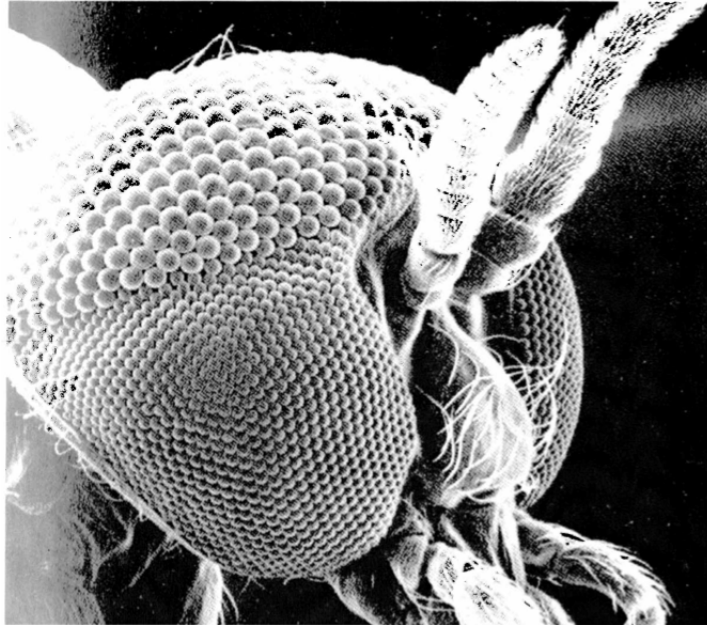

Example 2: The compound eye of insects (bees) consist of individual nerve cells [*ommatodium*]. The radius of the eye is $R = 2 \text{ mm}$, and the size of an ommatodium is $\delta \simeq 30 \mu\text{m}$. Why can the accuity of the eye *not* be increased by making the ommatodia smaller?

Solution: The angle between ommatodium follows $\Delta\theta_g = \delta/r$, and diffraction yields $\Delta\theta_d = \lambda/\delta$.

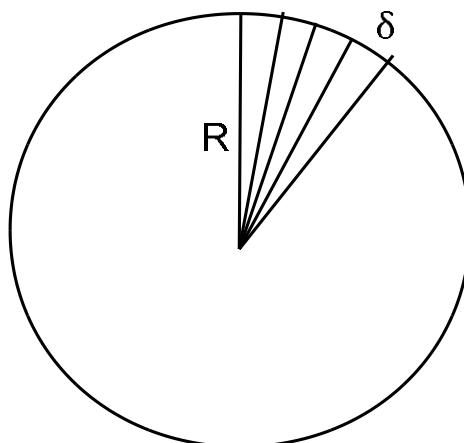

Thus, we cannot make δ too small! Combine the two effects:

$$\min \left(\frac{\delta}{r} + \frac{\lambda}{\delta} \right) \quad \text{or} \quad \frac{\delta}{r} = \frac{\lambda}{\delta}.$$

This condition gives $\delta = \sqrt{\lambda r}$. We insert the numerical value for the wavelength: $\lambda = 400 \text{ nm}$ to find the size of the ommatodium:

$$\delta = \sqrt{3 \times 10^{-3} \text{ m} \cdot 4 \times 10^{-7} \text{ m}} \simeq 35 \mu\text{m}.$$

Discussion: This values agrees with the size of the ommatodium.

A smaller value of δ would decrease the angle $\Delta\theta_g$, but increase the diffraction angle $\Delta\theta_d$; that is, it would not increase the accuity of vision.

In Young's double slit experiments, slits are used with widths much smaller than the distance d between them:

$$\sin \theta = m \frac{\lambda}{d} \quad m = 0, 1, 2, \dots \quad \text{bright fringes}$$

$$\sin \theta = (m + 1/2) \frac{\lambda}{d} \quad m = 0, 1, 2, \dots \quad \text{for dark fringes}$$

SIMPLY CLEVER

ŠKODA



We will turn your CV into
an opportunity of a lifetime



Do you like cars? Would you like to be a part of a successful brand?
We will appreciate and reward both your enthusiasm and talent.
Send us your CV. You will be surprised where it can take you.

Send us your CV on
www.employerforlife.com



Click on the ad to read more

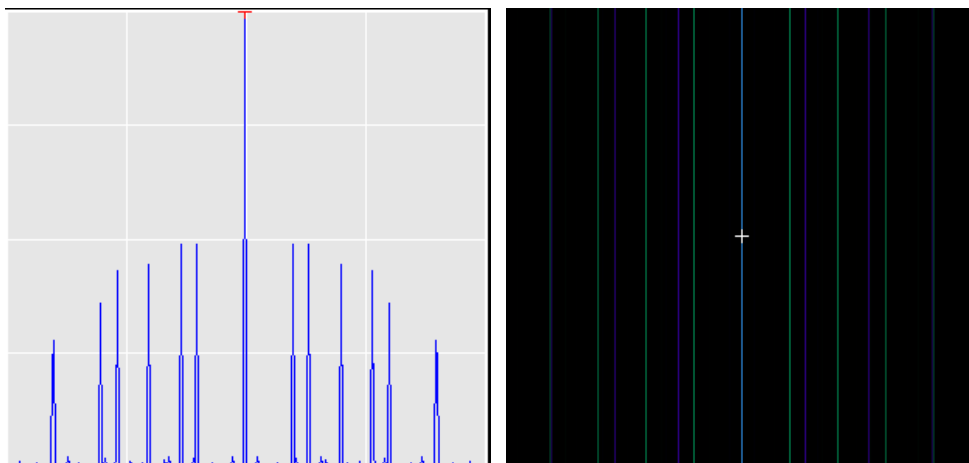

When the number N of slits is increased, the number of minima and maxima increases. The intensity of some minima does not change with N [principal maxima], whereas the intensity of great many maxima decreases as N increases [secondary maxima]. When N becomes of the order of hundred or thousand, the secondary minima can no longer be observed, and only the primary maxima 'survive.' This arrangement is called a diffraction grating. The angles of the m -th order principal maxima is given by

$$\sin \theta = \frac{m\lambda}{d}. \quad (22)$$

Example 3: Red light with wavelength $\lambda = 651 \text{ nm}$ is incident normally on a diffraction grating. **a)** The first order diffraction is observed at the angle $\theta = 14.0^\circ$. How many lines per cm does the diffraction grating have? **b)** If violet light $\lambda' = 408 \text{ nm}$ is used instead, what is the angle of the first diffraction line? **c)** What is the maximum order in which the red and violet line will be visible?

Solution: We have $\sin \theta = m\lambda/d$ with $m = 1$, then

$$\sin \theta = \frac{\lambda}{d} \quad \longrightarrow \quad d = \frac{\lambda}{\sin 14.0^\circ} = \frac{6.51 \times 10^{-7} \text{ m}}{\sin 14.0^\circ} = 2.7 \times 10^{-6} \text{ m}.$$

Thus, the number of lines per cm is: $N = 1.0 \times 10^{-2} \text{ m} / 2.7 \times 10^{-6} \text{ m} \simeq 3,700$. We have for $m = 1$:

$$\sin \theta' = \frac{\lambda'}{d} = \frac{4.08 \times 10^{-7} \text{ m}}{2.7 \times 10^{-6} \text{ m}} = 0.151 \quad \longrightarrow \quad \theta' = 8.7^\circ.$$

We have for the diffraction angle: $\theta = 90^\circ$ so that $m\lambda/d = 1$ so that for red light:

$$m = \frac{d}{\lambda} = \frac{2.7 \times 10^{-6} \text{ m}}{6.5 \times 10^{-7} \text{ m}} = 4.2 \quad \longrightarrow \quad m_{\text{max}} = 4,$$

and for violet light:

$$m' = \frac{d}{\lambda'} = \frac{2.7 \times 10^{-6} \text{ m}}{4.1 \times 10^{-7} \text{ m}} = 6.6 \quad \longrightarrow \quad m'_{\text{max}} = 6.$$

We have for the angle:

$$\sin \theta = \frac{m\lambda}{d} \quad \longrightarrow \quad \lambda = \frac{d \sin \theta}{m}.$$

Discussion: Diffraction can be used to resolve (small) structure. If the goal is to resolve crystalline structures of the order $d \sim 10^{-10}$ m [about an Angstrom, or a fraction of nanometer], electromagnetic waves with wavelength $\lambda \sim 10^{-10}$ m, i.e., X-rays must be used.

19 Special Relativity

Einstein's careful examination of the laws of electricity and magnetism of moving charges lead the Dutch physicist Lorentz (1853–1928) to propose modifications of time and length intervals. They were explained more fully by Einstein in 1905. The speed of light is an universal constant and is independent of the speed of the light source,

$$c = 2.9979 \times 10^8 \frac{\text{m}}{\text{s}}. \quad (23)$$

The concept of the ‘simultaneity’ of two events has to be examined very carefully: moving clocks run more slowly,

$$\Delta t = \frac{\Delta t_0}{\sqrt{1 - (v/c)^2}}. \quad (24)$$

This is referred to as “time dilation.” Furthermore, a moving observer sees a shorter length than an observer at rest:

$$L = L_0 \sqrt{1 - \left(\frac{v}{c}\right)^2}. \quad (25)$$

This is referred to as “Lorentz contraction.”

I joined MITAS because
I wanted **real responsibility**

The Graduate Programme
for Engineers and Geoscientists
www.discovermitas.com



Month 16
I was a construction supervisor in the North Sea advising and helping foremen solve problems

Real work
International opportunities
Three work placements





Example 1: The lifetime of a muon at rest is $\Delta t_0 = 2.2 \mu\text{s}$. Find the lifetime when the muon is traveling at the 99.8% of the speed of light.

Solution: We find

$$\Delta t = \frac{2.2 \mu\text{s}}{\sqrt{1 - 0.998^2}} = 34.8 \mu\text{s}.$$

Thus, the muon lives about 15 times longer when it is moving at speeds close to c .

Discussion: Muons travels the distance $d = 0.998 \cdot 2.9979 \times 10^8 \text{ m/s} \cdot 3.48 \times 10^{-5} \text{ s} \simeq 10^4 \text{ m}$, or about 10 km. Muons are produced in the atmosphere when cosmic rays interact with atoms; a fraction of the muon reach the Earth's surface.

Einstein showed that the concepts of mass and energy must also be revised.

$$E^2 = p^2 c^2 + m^2 c^4, \quad (\text{relativistic energy-momentum}). \quad (26)$$

Here m is the mass, E is the energy and p is the momentum of an object. This relation reflects a fundamental relation between energy and momentum. Two cases particularly noteworthy: (1) for particles with zero mass $m = 0$, we find

$$E = pc, \quad (27)$$

which implies that these particles travel at the speed of light c ; and (2) for particles at rest, $p = 0$, we find $E^2 = m^2 c^4$, or

$$E = mc^2. \quad (28)$$

This is the *equivalence of mass and energy*: energy can be 'converted' into mass, and conversely mass can be 'converted' into energy.

Example 2: The distance between Sun and the Earth is $R = 1.5 \times 10^8 \text{ km}$. **a)** The flux of energy per unit time and per unit area at the at the distance R from the sun is $S_0 = 1450 \text{ W/m}^2$ [the solar constant]. What is the total power radiated by the sun? **b)** The energy content of gasoline per kilogram is $5.0 \times 10^7 \text{ J/kg}$. What mass of gasoline would a hypothetical Sun have to burn every second to maintain its total output? **c)** The dominant nuclear reaction in the Sun is the *pp-chain* reaction in which hydrogen is transformed into helium in three steps:

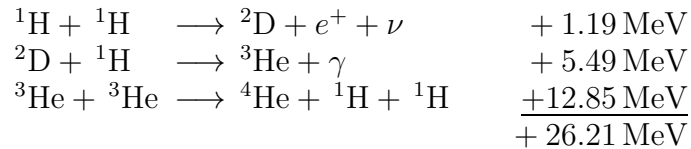

Find the mass of hydrogen that is transformed into helium every second inside the Sun's core! **d)** From the orbital period of the Earth around the Sun [i.e., $T = 1$ year], the mass of the Sun is found $M_{\text{sun}} = 2.0 \times 10^{30}$ kg. How long [in years] could the Sun last using either gasoline or nuclear energy?

Solution: We have for the power emitted by the sun:

$$P = S_0 A = 1450 \frac{\text{W}}{\text{m}^2} \cdot 4\pi (1.5 \times 10^{11} \text{ m})^2 = 4.1 \times 10^{26} \text{ W}.$$

The rate of mass conversion follows:

$$\frac{\Delta m}{t} = \frac{4.1 \times 10^{26} \text{ W}}{5 \times 10^7 \text{ J/kg}} = 8.2 \times 10^{18} \frac{\text{kg}}{\text{s}}.$$

In the *pp-chain* reaction, four hydrogen nuclei are transformed into a helium nuclei: We have $26.21 \text{ MeV} = 4.2 \times 10^{-12} \text{ J}$. Since the molar mass of hydrogen is $m = 1 \text{ g}$, we have

$$\frac{\Delta E}{\Delta m} = \frac{1}{4} \cdot \frac{6.02 \times 10^{23}}{1 \text{ g}} \cdot 4.2 \times 10^{-12} \text{ J} = 6.3 \times 10^{14} \frac{\text{J}}{\text{kg}}$$

We find the rate of mass conversion:

$$\frac{\Delta m}{\Delta t} = \frac{P}{\Delta E/\Delta m} = \frac{4.1 \times 10^{26} \text{ W}}{6.3 \times 10^{14} \text{ J/kg}} = 6.5 \times 10^{11} \frac{\text{kg}}{\text{s}}.$$

We find for the life time of the sun: $T_{\text{burn}} = M/(\Delta m/\Delta t)$:

Fuel	T_{burn} [years]
Gasoline	8,000
Nuclear	100 billion [10^{11}]

Discussion: The order of magnitudes are correct; however, details are incorrect. After a few billions years, the core becomes too dense and collapses under its own weight [and becomes a supernovae/neutron star].

20 Quantum Physics

20.1 Photons

In 1888, Heinrich Hertz observed sparks in metal tips when they were irradiated with ultraviolet light. Willhelm Hallwachs later found that a negatively charged zinc plate would discharge when illuminated by ultraviolet light, while a positively charged plate would not. This fact showed that this “photoelectric effect” consists in the emission of electrons from metal when illuminated with light of suitably short wavelength. We estimate the necessary time to emit an electron. We use filters that select only a small band of frequencies [blue] of the spectrum of the sun, that is the fraction 3.5×10^{-5} of the total energy of sunlight [$S = 1390 \text{ W/m}^2$]: the intensity is $I = 0.05 \text{ W/m}^2$. The radius of an atom is $r = 0.2 \text{ nm}$, and find the power supplied by the light to the atom: $P = 6 \times 10^{-21} \text{ W}$. The electron is bound to the atom with energy $E_B = 3 \text{ eV} \simeq 5 \times 10^{-19} \text{ J}$. We find the time to eject the electron $t_{\text{eject}} = E_B/P = 5 \times 10^{-19} \text{ J}/6 \times 10^{-21} \text{ W} = 80 \text{ s}$.

ie business school

#1 EUROPEAN BUSINESS SCHOOL
FINANCIAL TIMES 2013

#gobeyond

MASTER IN MANAGEMENT

Because achieving your dreams is your greatest challenge. IE Business School's Master in Management taught in English, Spanish or bilingually, trains young high performance professionals at the beginning of their career through an innovative and stimulating program that will help them reach their full potential.

- Choose your area of specialization.
- Customize your master through the different options offered.
- Global Immersion Weeks in locations such as London, Silicon Valley or Shanghai.

Because you change, we change with you.

www.ie.edu/master-management | mim.admissions@ie.edu | f t in YouTube

The remarkable fact is that the photoelectrons are observed immediately. While details of the above calculations are estimates, our calculation shows that the explanation of photoelectrons requires ‘new’ physics. Sir William Bragg described the strangeness of the effect: *It is as if one dropped a plank into the sea from the height of 100 feet, and found that the spreading of the ripple was able, after traveling 1000 miles and becoming infinitesimal in comparison with its original amount, to act on a wooden ship in such a way that a plank of that ship flew out of its place to a height of 100 feet.*

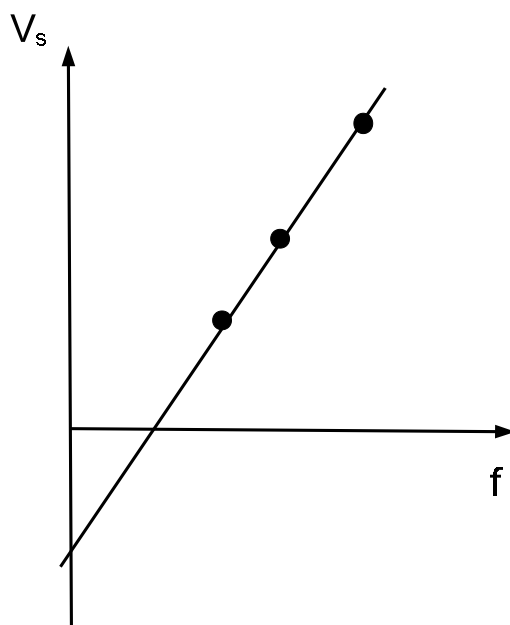
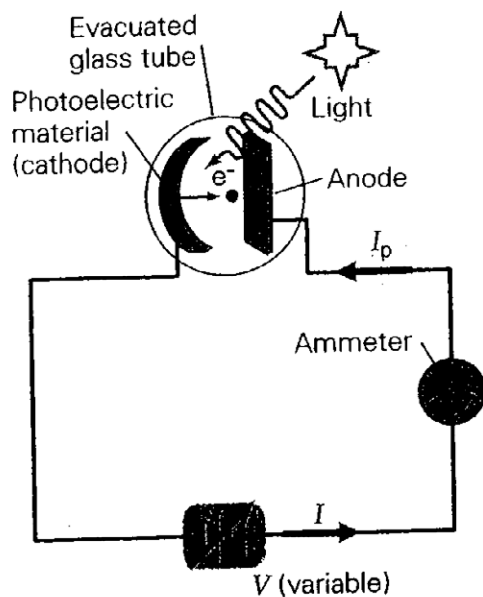

Following Max Planck, Albert Einstein asserted that light carries energy in *indivisible* amounts, or “quanta” [Nobelprize 1921]. In an experiment, the ejected electrons are collected by an anode, as shown. Explain why a positive current is measured when a positive voltage difference is applied between the anode and the cathode [metal]. When a negative voltage is applied, the photocurrent is zero: stopping potential V_s .

The stopping potential is a linear function of the frequency f of the light. Since eV_s , the slope defines an energy per frequency h so that the energy associated with light of frequency f is given by

$$E_\gamma = hf \quad h = 6.63 \times 10^{-34} \text{ Js.} \quad (29)$$

The constant h is Planck’s constant. There is a minimum frequency f_{\min} so that light with frequency $f < f_{\min}$ cannot produce photoelectrons. This frequency defines the “work function:”

$$W = hf_{\min}. \quad (30)$$

Example 1: The work function of gold (Au) is 5.4 eV. Find the longest wavelength of light capable of producing photoelectrons.

Solution: We find the smallest frequency:

$$f_{\min} = \frac{W}{h} = \frac{5.4 \cdot 1.6 \times 10^{-19} \text{ J}}{6.63 \times 10^{-34} \text{ Js}} = 1.3 \times 10^{15} \text{ Hz.}$$

The longest wavelength follows

$$\lambda_{\max} = \frac{c}{f_{\min}} = \frac{3.0 \times 10^8 \text{ m/s}}{1.3 \times 10^{15} \text{ s}^{-1}} = 230 \text{ nm.}$$

Discussion: This wavelength is less than that of violet light [400 nm].

Photons have zero mass and travel at the speed of light. The momentum follows $p = E/c = (hf)/c$, or

$$p = \frac{h}{\lambda}, \quad (31)$$

where we used $f/c = 1/\lambda$. Photons also carry angular momentum: $L = \pm h$, corresponding to right- and left- circularly polarized light.

Example 2: If a photon travels in an electric field [usually produced by a nucleus, such as ^{12}C], it can spontaneously disintegrate into an electron and a positron which is the “anti-particle” of the electron. Both electron and positron have mass $m = 9.11 \times 10^{-31} \text{ kg}$. This process is called *pair production*.
a) Calculate the smallest possible photon frequency that produces pair production by assuming that both electron and positron are at rest. **b)** Calculate the momentum of the photon from part a). What is the recoil velocity of ^{12}C as a result of pair production?

Solution: We have for the rest energy of the electron and positron:

$$E_e = E_p = mc^2 = 9.11 \times 10^{-31} \text{ kg} \cdot \left(3.0 \times 10^8 \frac{\text{m}}{\text{s}}\right)^2 = 8.2 \times 10^{-14} \text{ J} = 0.511 \text{ MeV}.$$

Thus, the energy of the incident photon is $E_\gamma = E_e + E_p = 1.04 \text{ MeV}$ so that the frequency is

$$E_\gamma = hf \quad \rightarrow \quad f = \frac{E_\gamma}{h} = \frac{2 \cdot 8.2 \times 10^{-14} \text{ J}}{6.63 \times 10^{-34} \text{ Js}} = 2.5 \times 10^{20} \text{ Hz}.$$

Since $E = pc$, we have for the momentum of the photon:

$$p_\gamma = \frac{E}{c} = \frac{2 \cdot 8.2 \times 10^{-14} \text{ J}}{3.0 \times 10^8 \text{ m/s}} = 5.5 \times 10^{-22} \frac{\text{kg} \cdot \text{m}}{\text{s}}.$$



STUDY AT A TOP RANKED INTERNATIONAL BUSINESS SCHOOL

Reach your full potential at the Stockholm School of Economics, in one of the most innovative cities in the world. The School is ranked by the Financial Times as the number one business school in the Nordic and Baltic countries.

Visit us at www.hhs.se





We have for the carbon mass $M = 12 \cdot 1.66 \times 10^{-27} \text{ kg} = 2.0 \times 10^{-26} \text{ kg}$. Then for the recoil speed:

$$v_C = \frac{p_\gamma}{M_C} = \frac{5.5 \times 10^{-22} \text{ kg} \cdot \text{m/s}}{2.0 \times 10^{-26} \text{ kg}} = 2.75 \times 10^4 \frac{\text{m}}{\text{s}}.$$

Discussion: This explains why pair production can only work in the presence of a charge [^{12}C in our case].

Example 3: A laser operates at frequency $f = 6.1 \times 10^{14} \text{ Hz}$. **a)** Calculate the momentum of the photon emitted by the laser. **b)** A helium atom flies towards the laser at a speed of $v = 3.5 \text{ m/s}$. During one laser pulse the gold atom absorbs on average 5 photons. Calculate the speed of the helium atom after one laser pulse. Treat the interaction between photons and the helium atom as an *inelastic* collision. Use $m = 4.0 \text{ u}$ for the mass of a helium atom.

Solution: We have for the wavelength $\lambda = c/f = (3.0 \times 10^8 \text{ m/s})/(6.1 \times 10^{14} \text{ Hz}) = 492 \text{ nm}$. The momentum follows

$$p = \frac{h}{\lambda} = \frac{6.63 \times 10^{-34} \text{ Js}}{4.92 \times 10^{-7} \text{ m}} = 1.35 \times 10^{-27} \frac{\text{kg} \cdot \text{m}}{\text{s}}.$$

Total momentum of photons:

$$p_{\text{tot}} = 5 \cdot 1.35 \times 10^{-27} \text{ kg} \cdot \text{m/s} = 6.75 \times 10^{-27} \text{ kg} \cdot \text{m/s}.$$

Mass of helium atom $M = 4.0 \cdot 1.6605 \times 10^{-27} \text{ kg} = 6.64 \times 10^{-27} \text{ kg}$. Momentum of the helium atom before collision:

$$P = Mv = 6.64 \times 10^{-27} \text{ kg} \cdot 3.5 \text{ m/s} = 2.324 \times 10^{-26} \text{ kg} \cdot \text{m/s}.$$

Use conservation of momentum to calculate the speed after the “collision:”

$$Mv' = P - p_{\text{tot}} = 1.65 \times 10^{-26} \frac{\text{kg} \cdot \text{m}}{\text{s}}, \quad \rightarrow \quad v' = \frac{1.65 \times 10^{-26} \text{ kg} \cdot \text{m/s}}{6.64 \times 10^{-27} \text{ kg}} = 2.5 \frac{\text{m}}{\text{s}}.$$

The explanation of these experiments are strikingly simple: photons are treated as if they are particles with momentum p and energy $E = pc$. This particle-like property of photons contradicts the wave-like properties of light, namely interference and diffraction. For example, in Young’s double slit experiment, interference implies that the photon can take the path through either of the two slits: it cannot be determined which slit the photon has taken without destroying interference effects altogether.

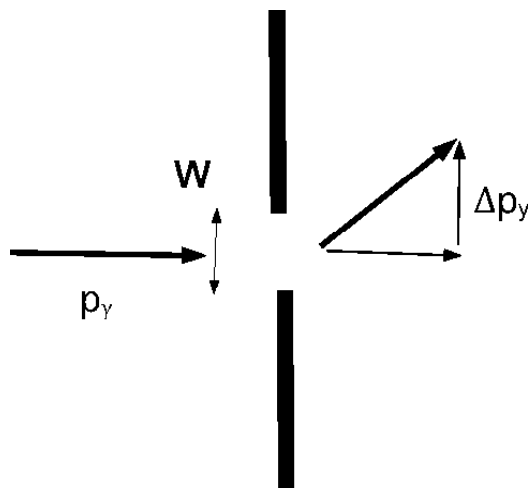

A photon with momentum $p_x = p_\gamma$ travels towards an opening with width W . The photon is scattered away from the forward direction. We use small angle approximation $\tan \theta \simeq \sin \theta$ and find $\tan \theta = \Delta p_y / p_x = \Delta p_y / (h/\lambda)$ so that $\Delta p_y \cdot W \simeq h$. In general: $\Delta p \cdot \Delta x \geq h/4\pi$. This is Heisenberg's uncertainty relation: if an attempt is made to 'localize' a photon, the momentum of photon becomes uncertain. If the momentum of the photon is fixed (corresponding to monochromatic light), the electromagnetic wave is infinitely extended.

20.2 Wave nature of particles

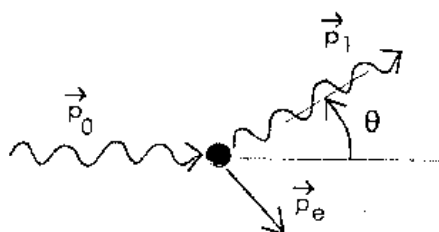

Electrons are elementary particles, i.e., they have no radius and also have no internal degrees of freedom. Thus, if a photon scatters off an electron [so-called Compton effect], the interaction can be analyzed by the condition of the conservation of energy:

$$\frac{hc}{\lambda} - \frac{hc}{\lambda'} = \frac{p_e^2}{2m_e} \tag{32}$$

and momentum:

$$\frac{h}{\lambda} - \frac{h}{\lambda'} = p_e \tag{33}$$

These equations have no solution: this corresponds to the experimental fact that not all photons are scattered in the same direction. If the photon is scattered in the direction θ away from the forward direction, one finds for the change in the wavelength: $\lambda' - \lambda = \lambda_e(1 - \cos \theta)$, where $\lambda_e = h/m_e c = 2.43 \times 10^{-12}$ m is the Compton wavelength. The Compton effect suggests that particles, such as electrons can have wave-like properties. Particle-like properties are energy and momentum (E, p) and wave-like properties are frequency and wavelength (λ, f) . The French physicist deBroglie suggested that the description of a particle with momentum p follows from $p = h/\lambda$, or

$$\lambda = \frac{h}{p}.$$

This relationship describes the wave nature of an object with momentum $p = mv$.

Example 4: An electron is accelerated through the electrostatic potential $\Delta V = 1$ kV. Find the wavelength of the electron.

Solution: The kinetic energy is $E = 1.0$ V = 1.6×10^{-16} J. Since $m = 9.1 \times 10^{-31}$ kg so that

$$v = \sqrt{\frac{2 \cdot 1.6 \times 10^{-16} \text{ J}}{9.1 \times 10^{-31} \text{ kg}}} = 5.9 \times 10^5 \frac{\text{m}}{\text{s}}.$$



#1
in eco-friendly
attitude

**STUDY AT
LINKÖPING UNIVERSITY, SWEDEN**
RANKED AMONG TOP 50 UNIVERSITIES UNDER 50

Interested in Strategy and Management in International Organisations? Kick-start your career with a master's degree from Linköping University, Sweden.

→ **Click here!**

 **Linköping University**

The momentum thus follows $p = 9.1 \times 10^{-31} \text{ kg} \cdot 5.9 \times 10^5 \text{ m/s} = 5.4 \times 10^{-25} \text{ kg m/s}$. The wavelength follows

$$\lambda = \frac{h}{p} = \frac{6.63 \times 10^{-34} \text{ Js}}{5.4 \times 10^{-25} \text{ kg m/s}} = 1.2 \times 10^{-9} \text{ m}.$$

Discussion: This wavelength of the electron is comparable to the spacing of atoms in crystals. Thus, crystals can be used to probe the wave-nature of electrons [Davisson-Germer experiment].

Electrons show all phenomena associated with waves, particularly diffraction and interference. The underlying physics was discovered by Schrödinger, Heisenberg, Bohr, and Born [among many others] during the first two decades at the beginning of the 20th-century. A discussion is however outside the scope of introductory physics. In the following example, we study standing waves of electrons. Recall that standing waves are generated by the superposition of an incoming and reflected waves. An electron is contained in a box of length a . The possible wavelengths follow from the condition that the amplitude is zero at the boundaries: $n\lambda/2 = a$ so that

$$\lambda = \frac{2a}{n}. \quad (34)$$

This gives for the momentum of particles $p = h/\lambda = h/(2a/n) = nh/2a$. The kinetic energy of atoms follows:

$$KE = \frac{mv^2}{2} = \frac{p^2}{2m} = \frac{(nh/2a)^2}{2m} = \frac{h^2}{8ma^2}n^2. \quad (35)$$

Thus ground state is $n = 1$ with $E_1 = h^2/(8ma^2)$; in particular, the zero-energy state is not possible.

Example 5: The electronic states of a dye molecule are approximated by a particle in a box [one-dimensional]. The box has length of $a = 1.3 \text{ nm}$. **a)** Calculate the four longest wavelengths. **b)** What are the corresponding frequencies? Can you see the lines?

Solution: We have

$$E_n = \frac{h^2}{8ma^2}n^2 = E_1n^2.$$

with

$$E_1 = \frac{h^2}{8ma^2} = \frac{(6.63 \times 10^{-34} \text{ Js})^2}{8 \cdot 9.11 \times 10^{-31} \text{ kg} \cdot (1.3 \times 10^{-9} \text{ m})^2} = 3.57 \times 10^{-20} \text{ J} = 0.221 \text{ eV}.$$

We can see the four largest line:

Transition	ΔE [eV]	$f = \Delta E/h$ [Hz]	$\lambda = c/f$ [nm]
$2 \rightarrow 1$	$3E_1 = 0.663$	1.61×10^{14}	1856
$3 \rightarrow 2$	$5E_1 = 1.105$	2.69×10^{14}	1114
$4 \rightarrow 3$	$7E_1 = 1.547$	3.77×10^{14}	796
$3 \rightarrow 1$	$8E_1 = 1.768$	4.31×10^{14}	696

These lines are all in the visible range.

20.3 Atomic Physics

We imagine that the electron in a hydrogen atom moves in circular orbits with radius r around the nucleus [Note that this picture is wrong in many important aspects]. In a stationary “state,” a multiple of the wavelength of the electron matches the length of the orbit: $\lambda = 2\pi r/n$. Since $\lambda = h/p$, we get $2\pi r = nh/p$ so that for the angular momentum of the electron:

$$L = mvr = n \frac{h}{2\pi}, \quad (36)$$

i.e., angular momentum is “quantized” [Niels Bohr (Nobelprize 1913)].

Since $\text{KE} = p^2/2m$ is the kinetic energy, we find $\text{KE} = (hn)^2/(8\pi^2mr^2)$. The (electrostatic) potential energy of the electron. We have for two charges q_1 and q_2 separated by the distance r : $\text{PE} = -ke^2/r$. The total energy of the electron $E_{\text{tot}} = \text{KE} + \text{PE}$ follows $E_{\text{tot}} = (hn)^2/(8\pi^2mr^2) - ke^2/r$. We consider the total energy as a function of the radius, and observe that the function has a minimum at the radius $r = 2(hn)^2/8\pi^2m \cdot 1/ke^2$, or

$$r = a_0 n^2, \quad (37)$$

where $a_0 = h^2/(4\pi^2kme^2) = 5.29 \times 10^{-11}$ m is the so-called Bohr radius. The corresponding energy follows $E_{\text{min}} = -(1/4)(ke^2)^2 \cdot 8\pi^2m/(hn)^2$, or

$$E_n = -\frac{E_1}{n^2}, \quad (38)$$

where $E_1 = 13.6$ eV. The total energy is *negative*: the electron is bound to the proton. The state $n = 1$ is the ground state, and $n = 2, 3, \dots$ correspond to the first, second, etc excited states.

Example 6: An electron is in the second excited state and “jumps” to the second excited states. In this process, a photon is emitted. **a)** Find the wavelength of the emitted photon. **b)** Find the recoil speed of the hydrogen atom.

Solution Since $E = hf = hc/\lambda$, we find

$$\frac{1}{\lambda} = \frac{(E_f - E_i)/h}{c} = \frac{2.18 \times 10^{-18} \text{ J}}{6.63 \times 10^{-34} \text{ Js} \cdot 3.0 \times 10^8 \text{ m/s}} \left(\frac{1}{2^2} - \frac{1}{3^2} \right) = \frac{1}{6.57 \times 10^{-9} \text{ m}}$$

so that $\lambda = 657 \text{ nm}$: this is in the visual part of the spectrum of electromagnetic light. We have for the momentum of the photon: $p = h/\lambda = 1.01 \times 10^{-27} \text{ kg m/s}$. Since the mass of the hydrogen atom is $m_{\text{H}} = 1 \text{ u} = 1.66 \times 10^{-27} \text{ kg}$, we find the recoil speed:

$$v_{\text{recoil}} = \frac{p}{m_{\text{H}}} = \frac{1.01 \times 10^{-27} \text{ kg m/s}}{1.66 \times 10^{-27} \text{ kg}} = 0.6 \frac{\text{m}}{\text{s}}.$$

Discussion: The quantity

$$R = \frac{E_1}{hc} = 1.097 \times 10^7 \text{ m}^{-1}.$$

is called the Rydberg constant.

“I studied English for 16 years but...
...I finally learned to speak it in just six lessons”
Jane, Chinese architect

ENGLISH OUT THERE

Click to hear me talking before and after my unique course download

The integer n is called the *principal* quantum number. The *orbital* quantum number can have values $l = 0, 1, 2, \dots, (n - 1)$. The *magnetic* quantum number m_l is related to the (orientation of angular momentum $L_z = m_l h/2\pi$): $m_l = -l, -(l - 1), \dots, -1, 0, 1, \dots, l$. “spin” quantum number [internal degree of freedom of electron] m_s : $m_s = \pm 1/2$. Pauli’s exclusion principle states that two electrons on an atom cannot have identical sets of quantum numbers (n, l, m, m_s) : this principle explains the “shell structure” of atoms.

21 Nuclear Physics

A nucleus consists of protons and neutrons. The radius of a nucleus is of the order of femtometers 10^{-15} m. Since protons are positively charged, there are enormous Coulomb repulsive forces acting between protons, and there must be an even greater attractive nuclear force acting between them: strong nuclear force. The nuclear force does not distinguish between protons and neutrons, and the presence of neutrons further stabilizes the nucleus. We have A : number of nucleons [protons and neutrons]; Z : number of protons (atomic number); and N : number of neutrons. We write

$${}^A_Z X,$$

where X is the symbol for the element. Nuclei with the same X but different numbers of neutrons, are called *isotopes*.

The mass of an electron, proton, and neutrons are in units of kilogram [kg] and atomic mass unit [$1 \text{ u} = 1.661 \times 10^{-27} \text{ kg}$],

	m [kg]	m [u]	m [MeV]
Electron	9.11×10^{-31}	5.5×10^{-4}	0.5
Proton	1.672×10^{-27}	1.007	938.3
Neutron	1.675×10^{-27}	1.009	939.6

where we use the equivalence of mass and energy $E = mc^2$ and find $1 \text{ u} \cdot c^2 = 931.5 \text{ MeV}$.

The mass of an nucleus is smaller than the sum of of the rest masses:

$$M = Z m_p + (N - Z) m_n - \Delta m, \quad (39)$$

where Δm is the mass defect. The binding energy between nucleons [protons and neutrons] yields the mass defect:

$$E_B = \Delta m c^2. \quad (40)$$

Example 1: The mass of a carbon atom is $M_c = 12.011 \text{ u}$. Find the mass defect of the carbon and **b)** the binding energy per nucleon.

Solution: Since the carbon atom has 6 protons and neutrons, we have 6 protons and 6 neutrons:

$$M_{\text{tot}} = 6m_p + 6m_n = 6 \cdot 1.007 \text{ u} + 6 \cdot 1.009 \text{ u} = 12.10 \text{ u} > M_c;$$

thus the mass defect is $\Delta m = 0.085 \text{ u} = 79 \text{ MeV}$ so that

$$\frac{E_B}{\text{number of nucleon}} = \frac{79 \text{ MeV}}{12} = 6.6 \text{ MeV}.$$

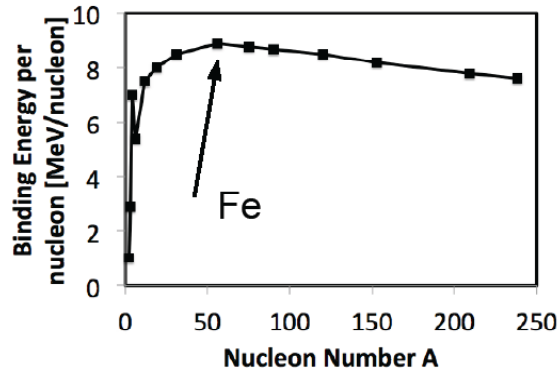

Excellent Economics and Business programmes at:



university of
 groningen



**“The perfect start
 of a successful,
 international career.”**

CLICK HERE
 to discover why both socially
 and academically the University
 of Groningen is one of the best
 places for a student to be

www.rug.nl/feb/education

The binding energy per nucleon has a maximum at iron [Fe]: this is the most stable element. It follows that energy can be released by two different types of nuclear reactions: (i) *fusion* – when two lighter elements combine and from a heavier element [example: two deuterons [heavy water] combine to form a helium nucleus], and (ii) *fission* when a heavy nucleus splits into a lighter nucleus and a helium nucleus [α -particle]. Hydrogen and helium were created during the *Big Bang*, all other elements are thermonuclear debris from stars. In particular, gold and silver can only be produced when stars ‘explode’ as supernovae.

Nuclei decay in three-different ways. α -decay: release of He nucleus



β -decay: release of an electron or a positron [“anti-particle” of electron]:



i.e., a neutron is converted into a proton, γ -decay:



where P^* is an excited state.

The number of nuclei depends on time $N = N(t)$:

$$\frac{\Delta N}{N} = \frac{N(t + \Delta t) - N(t)}{N(t)} = -\lambda \Delta t = \text{const.} \quad (44)$$

Here, λ is called decay constant; the SI-unit is $\lambda = \text{s}^{-1}$. The half life $t_{1/2}$ is defined as the time when the number of radioactive nuclei has dropped to half of its original number $N(t_{1/2}) = N_0/2 = N_0 \exp(-\lambda t_{1/2})$ so that

$$t_{1/2} = \frac{\ln 2}{\lambda}. \quad (45)$$

Activity is defined as the number of decays per second,

$$\text{Activity} = \frac{\Delta N}{\Delta t} = -\lambda N(t) = -\lambda N_0 e^{-\lambda t}.$$

The SI-unit of activity is Becquerel $1 \text{ Bq} = 1 \text{ s}^{-1}$.

Example 2: The natural abundance of ${}^{14}_6\text{C}$ isotope in the atmosphere is $1/8.3 \times 10^{11}$. The half-life is $t_{1/2} = 5730 \text{ yr}$. Find the radioactivity of 1-g of carbon sample.

Solution: We find the number of carbon atom in 1 gram from Avogadro's number:
 $N_{\text{total}} = N_A/12 = 5.0 \times 10^{22}$ so that for the number of radioactive nuclei:

$$N_{14} = \frac{5.0 \times 10^{22}}{8.3 \times 10^{11}} = 6.0 \times 10^{10}.$$

We have the decay constant $\lambda = \ln 2/t_{1/2} = 3.8 \times 10^{-12} \text{ s}^{-1}$. This gives

$$A_0 = \lambda N_{14} = 3.8 \times 10^{-12} \text{ s}^{-1} \cdot 6.0 \times 10^{10} = 0.23 \text{ Bq}.$$

Example 3: The measured activity of a 1-g carbon sample of "Özi" [the Iceman found in the Austrian alps] is $A = 0.121 \text{ Bq}$. How long ago did Özi die?

Solution: Since $A = \lambda N$, the activity decays exponentially in time:

$$A(t) = A_0 e^{-\lambda t} \quad \longrightarrow \quad \lambda t = -\ln \left(\frac{A}{A_0} \right) = -\ln \left(\frac{0.121 \text{ Bq}}{0.23 \text{ Bq}} \right) = 0.642.$$

This gives $t = 5,300 \text{ yr}$.

Exposure describes a situation when beam of charge q passing through air of mass m :
 Exposure (in roentgen) = $1/(2.58 \times 10^{-4}) \cdot q/m$. The absorbed dose measures the energy per mass of absorbing material: Absorbed dose = energy absorbed/mass of absorbing material
 The SI-unit is $1 \text{ Gy} = 1 \text{ J/kg}$ and $1 \text{ rad} = 0.01 \text{ Gy}$. An excellent resource for "all things nuclear" [weapons, power, ...] is R.A. Miller, *Physics for Future Presidents* (W.W. Norton, New York, 2008).