

Concise Hydraulics

Prof. Dawei Han



Download free books at

bookboon.com

Dawei Han

Concise Hydraulics

Concise Hydraulics

1st edition

© 2008 Dawei Han & bookboon.com

ISBN 978-87-7681-396-3

Contents

	Preface	9
1	Fundamentals	10
1.1	Properties of Fluids	10
1.2	Flow Description	11
1.3	Fundamental Laws of Physics	12
2	Hydrostatics	15
2.1	Pressure	15
2.2	Manometer	16
2.3	Pressure Force on Plane Surface	17
2.4	Pressure Force on Curved Surface	18
2.5	Flotation	19
3	Energy Equation	27
3.1	Basic Formula	27
3.2	Applications	28

www.sylvania.com

We do not reinvent the wheel we reinvent light.

Fascinating lighting offers an infinite spectrum of possibilities: Innovative technologies and new markets provide both opportunities and challenges. An environment in which your expertise is in high demand. Enjoy the supportive working atmosphere within our global group and benefit from international career paths. Implement sustainable ideas in close cooperation with other specialists and contribute to influencing our future. Come and join us in reinventing light every day.

Light is OSRAM

OSRAM SYLVANIA



4	Momentum Equation	34
4.1	The Principle	34
4.2	Applications	35
5	Pipe Flow	43
5.1	Introduction	43
5.2	Energy losses in pipe flow	44
5.3	Local losses (<i>or Minor losses</i>)	47
5.4	Grade Line	47
5.5	Combination of pipes	47
5.6	Energy Loss in Non-circular Pipes	48
6	Physical Modelling	53
6.1	Background	53
6.2	Dimensional Analysis	53
6.3	Analysis of Experimental Data	56
6.4	Model and Similarity	57



Discover the truth at www.deloitte.ca/careers

Deloitte.

© Deloitte & Touche LLP and affiliated entities.



Click on the ad to read more

7	Open Channel Flow	63
7.1	What is “Open Channel Flow”	63
7.2	Channel Geometric Properties	64
7.3	Calculation of Hydraulic Radius and Hydraulic Mean Depth	66
8	Uniform Flow	73
8.1	Introduction	73
8.2	Laminar or Turbulent Flow	73
8.3	Energy Loss Equations	74
8.4	Computation of Uniform Flow	76
9	Channel Design	83
9.1	Channel Design	83
9.2	Compound Channel	83
9.3	The Best Hydraulic Section	86
10	Critical Flow	94
10.1	Small Wave in Open Channel	94
10.2	Critical Flow	94
10.3	Critical Flow Computation	96

SIMPLY CLEVER

ŠKODA



We will turn your CV into
an opportunity of a lifetime

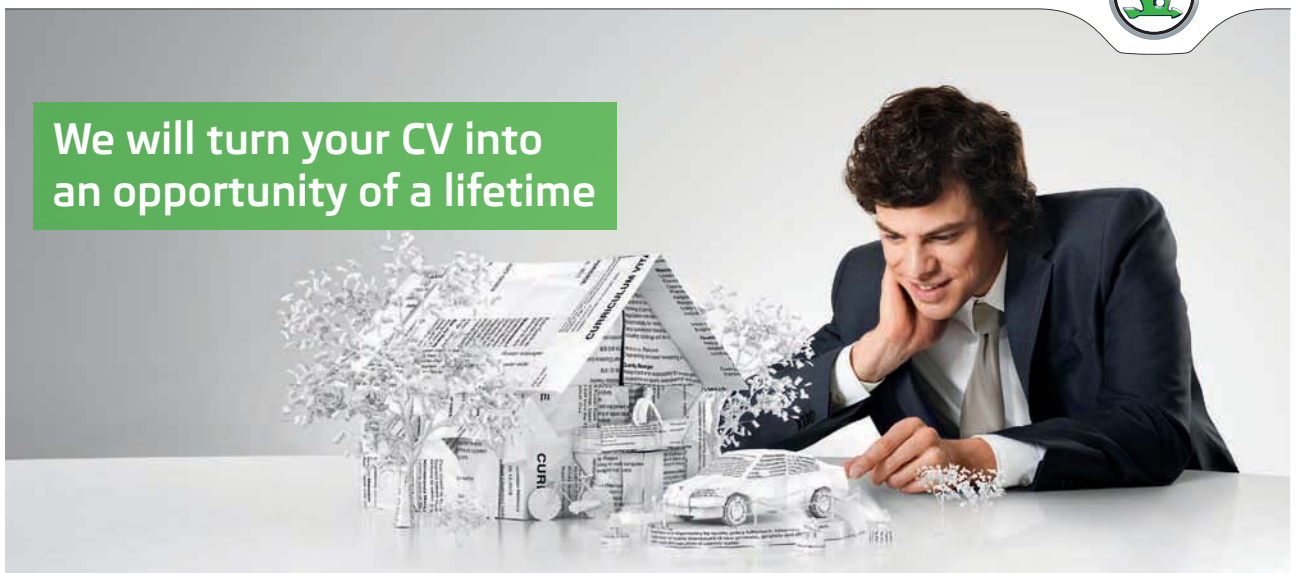

Do you like cars? Would you like to be a part of a successful brand?
We will appreciate and reward both your enthusiasm and talent.
Send us your CV. You will be surprised where it can take you.

Send us your CV on
www.employerforlife.com



Click on the ad to read more

11	Rapidly Varied Flow	103
11.1	Sudden Transitions	103
11.2	Depth of Flow	104
11.3	Height of Hump	106
11.4	Specific Energy	107
12	Hydraulic Jump	114
12.1	Jump Equation	114
12.2	Hydraulic Jump in Rectangular Channel	117
12.3	Hydraulic Jump in Trapezoidal Channel	117
12.4	Hydraulic jump in Sloping Channel	119
13	Hydraulic Structures	124
13.1	Flumes (Venturi)	124
13.2	Weirs (Broad-crested weir)	126
13.3	Energy dissipators	127
13.4	Sluice Gates	129

I joined MITAS because
I wanted **real responsibility**

The Graduate Programme
for Engineers and Geoscientists
www.discovermitas.com



Month 16

I was a construction supervisor in the North Sea advising and helping foremen solve problems

Real work
International opportunities
Three work placements



Click on the ad to read more

14	Gradually Varied Flow	133
14.1	Equation of Gradually Varied Flow	133
14.2	Classification of Surface Profiles	135
14.3	Flow Profile Sketch	136
14.4	Flow transitions	138
15	Computation of Flow Profile	142
15.1	Introduction	142
15.2	Numerical integration methods	142
15.3	Computation Procedure through an Example	144
15.4	Further Computational Information	146
16	Unsteady Flow	152
16.1	Basic Types	152
16.2	Rapidly Varied Unsteady Flow	153
16.3	Gradually Varied Unsteady Flows (Saint-Venant equations)	155
16.4	Software packages	159
17	Hydraulic Machinery	164
17.1	Hydropower and Pumping Station	164
17.2	Turbines	166
17.3	Pump and Pipeline	169
18	Appendix: Further Reading Resources	182

Preface

Hydraulics is a branch of scientific and engineering discipline that deals with the mechanical properties of fluids, mainly water. It is widely applied in many civil and environmental engineering systems (water resources management, flood defence, harbour and port, bridge, building, environment protection, hydropower, irrigation, ecosystem, etc.). This is an introductory book on hydraulics and written for undergraduate students in civil and environmental engineering, environmental science and geography. The aim of this book is to provide a concise and comprehensive coverage of hydraulics that is easy to access through the Internet.

The book content covers the fundamental theories (continuity, energy and momentum equations), hydrostatics, pipe flow, physical modelling (dimensional analysis and similarity), open channel flow, uniform flow, channel design, critical flow, rapidly varied flow, hydraulic jump, hydraulic structures, gradually varied flow, computation of flow profile, unsteady flow and hydraulic machinery (pump and turbine). The text has been written in a concise format that is integrated with the relevant graphics. There are many examples to further explain the theories introduced. The questions at the end of each chapter are accompanied by the corresponding answers and full solutions. A list of recommended reading resources is provided in the appendix for readers to further explore the interested hydraulics topics.

Due to its online format, it is expected that the book will be updated regularly. If you find any errors and inaccuracies in the book, you are encouraged to email me with feedback and suggestions for further improvements.

Dawei Han

Reader in Civil and Environmental Engineering,

Water and Environmental Management Research Centre

Department of Civil Engineering

University of Bristol, BS8 1TR, UK

E-mail: d.han@bristol.ac.uk

<http://www.bris.ac.uk/civilengineering/person/d.han.html>

August 2008

1 Fundamentals

Hydraulics is a branch of scientific and engineering discipline that deals with the mechanical properties of fluids, mainly water. It is widely applied in water resources, harbour and port, bridge, building, environment, hydropower, pumps, turbines, etc.

1.1 Properties of Fluids

1. **Density:** Mass per unit volume ρ (kg/m^3)

For water, $\rho = 1000 \text{ kg/m}^3$ at 4°C ,

$\rho = 998 \text{ kg/m}^3$ at 20°C

For air, $\rho = 1.2 \text{ kg/m}^3$ at 20°C at standard pressure

2. **Specific gravity:** Ratio of the substance's density and water's density at 4°C
3. **Pressure:** Normal fluid force divided by area over which it acts (N/m^2). (Note: pressure is scalar while force is a vector. A force is generated by the action of pressure on a surface and its direction is given by the surface orientation)
4. **Viscosity and shear stress**

Take an element from the fluid

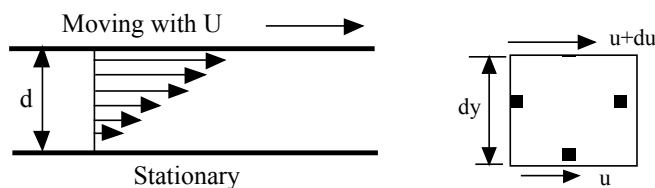

$$\tau = \mu \frac{du}{dy}$$

and the total force

$$F = \tau A = \mu \frac{UA}{d}$$

where μ absolute viscosity (N s/m^2), τ shear stress (N/m^2). Fluids that follow the aforementioned formulas are called **Newtonian fluids**.

Examples

Air	$\mu = 1.79 \times 10^{-5} \text{ N s/m}^2$
Water	$\mu = 1.137 \times 10^{-3} \text{ N s/m}^2$
Engine oil SAE30W	$\mu = 0.44 \text{ N s/m}^2$

High viscosity: sticky fluid; low viscosity: slippery fluid

μ is not a constant and changes with temperature.

Another form of viscosity is kinematic viscosity $\nu = \frac{\mu}{\rho}$ (m²/s)

Assumptions for the equation:

1. Fluids are *Newtonian fluids* (Non-Newtonian fluids are studied by Rheology, the science of deformation and flow);
2. The continuum approximation: the properties of the fluid can be represented by continuous fields representing averages over many molecules (The exception is when we are dealing with gases at low pressures).

1.2 Flow Description

There are two approaches

1. Lagrangian approach: follow individual fluid element as it moves about;
2. Eulerian approach: focus on a fixed location and consider how the fluid properties change at that location as time goes on.

Definitions relating to Fluids in Motion

Ideal flow: frictionless and incompressible (i.e. nonviscous).

Steady flow: The flow is steady if the properties at each point in the fluid do not change with time.

One, Two and 3D flows:

One dimensional flow requires only one coordinate to describe the change in flow properties.

Two dimensional flow requires two coordinates to describe the change in flow properties.

Three dimensional flow requires all three coordinates to describe the change in flow properties.

In general, most flow fields are three dimensional. However, many practical problems can be simplified into one or two dimensions for computational convenience.

Control Volume

A suitable mass of fluid can be identified by using control volume. A control volume is a purely imaginary region within a body of flowing fluid. The region is usually at a fixed location and of fixed size. Inside the region, all the dynamic forces cancel each other. Attention may therefore be focused on the forces acting externally on the control volume.

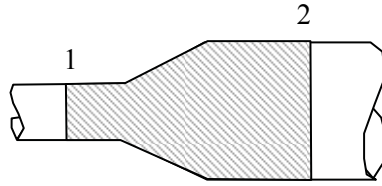

1.3 Fundamental Laws of Physics

The fundamental equations that govern the motions of fluids such as water are derived from the basic laws of physics, i.e., the conservation laws of mass, momentum and energy. The conservation of momentum comes from Newton's second law of motion stated in 1687 in *Principia Mathematica*. The law of conservation of mass was formulated in the late eighteenth century and the law of conservation of energy in the mid-nineteenth century. In modern physics, mass and energy can be converted from one to the other as suggested by Albert Einstein in 1905. This combines two individual conservation laws into a single law of conservation of mass/energy. However, since conversion between mass and energy are not of relevance to fluids studied by hydraulics, the two individual laws of conservation are used in hydraulics. The conservation of mass is also called the equation of continuity.

Conservation of mass: mass can be neither created nor destroyed.

Conservation of energy: energy can be neither created nor destroyed.

Conservation of momentum: a body in motion cannot gain or lose momentum unless some external force is applied.

The application of the three fundamental laws will be further explained in the following chapters.

<p style="text-align: center;">Questions 1 <i>Fundamentals</i></p>

1. A plate separated by 0.5 mm from a fixed plate moves at 0.5 m/s under a shear stress of 4.0 N/m². Determine the viscosity of the fluid between the plates.

(Answer: 0.004 Ns/m²)

2. A Newtonian fluid fills the gap between a shaft and a concentric sleeve. When a force of 788N is applied to the sleeve parallel to the shaft, the sleeve attains a speed of 2m/s. If a 1400 N force is applied, what speed will the sleeve attain? The temperature of the sleeve remains constant.

(Answer: 3.55 m/s)

3. Water is moving through a pipe. The velocity profile at some section is shown below and is given mathematically as $u = \frac{\beta}{4\mu} \left(\frac{d^2}{4} - r^2 \right)$, where u = velocity of water at any position r , b = a constant, m = viscosity of water, d = pipe diameter, and r = radial distance from centreline. What is the shear stress at the wall of the pipe due to water? What is the shear stress at a position $r = d/4$? If the given profile persists a distance L along the pipe, what drag is induced on the pipe by the water in the direction of flow over this distance?

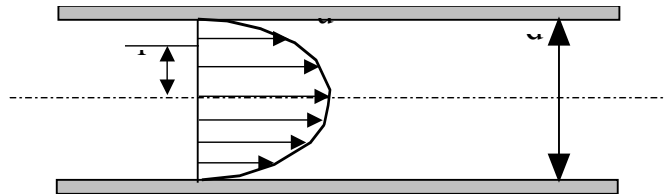

(Answer: $\beta d/4$, $\beta d/8$, $\beta d^2 \pi L/4$)

Solutions 1
Fundamentals

1. From $\tau = \mu \frac{U}{d}$

$$4.0 = \mu \frac{0.5}{0.5 \times 0.001},$$

so $\mu = 0.004 \text{ Ns/m}^2$
2. $\tau = \frac{F}{A} = \mu \frac{U}{d}$

Rearrange as $\frac{F}{U} = \frac{\mu A}{d} = \text{constant}$

Therefore, $\frac{F_1}{U_1} = \frac{F_2}{U_2}$,

$$\frac{788}{2} = \frac{1400}{U_2}$$

So $U_2 = 3.55 \text{ m/s}$
3. From $u = \frac{\beta}{4\mu} \left(\frac{d^2}{4} - r^2 \right)$

so $\frac{du}{dr} = \frac{\beta}{4\mu} (-2r) = -\frac{\beta r}{2\mu}$

Then $\tau = \mu \frac{du}{dr} = -\frac{\beta r}{2}$

At the wall, $r = d/2$,

hence $\tau_{wall} = -\frac{\beta d}{4}$,

$$\tau_{r=d/4} = -\frac{\beta d}{8} \text{ (The negative signs can be ignored)}$$

$$\text{Drag} = \tau_{wall}(\text{area}) = \frac{\beta d}{4} (\pi d L) = \beta d^2 \pi L / 4$$

ie business school

#1 EUROPEAN BUSINESS SCHOOL
FINANCIAL TIMES 2013

#gobeyond

MASTER IN MANAGEMENT

Because achieving your dreams is your greatest challenge. IE Business School's Master in Management taught in English, Spanish or bilingually, trains young high performance professionals at the beginning of their career through an innovative and stimulating program that will help them reach their full potential.

- Choose your area of specialization.
- Customize your master through the different options offered.
- Global Immersion Weeks in locations such as London, Silicon Valley or Shanghai.

Because you change, we change with you.

www.ie.edu/master-management | mim.admissions@ie.edu | Facebook | Twitter | LinkedIn | YouTube | Instagram



2 Hydrostatics

Hydrostatics deals with the pressures and forces resulting from the weight of fluids at rest.

2.1 Pressure

Pressure is the force per unit area acting on a surface and it acts equally in all directions. A common pressure unit is N/m^2 , also called Pascal (Pa). Depending on the benchmark used (with/without atmospheric pressure), pressure can be described as absolute pressure or relative pressure.

1. Atmospheric pressure (p_a): is the pressure at any given point in the Earth's atmosphere caused by the weight of air above the measurement point. The standard atmosphere (symbol: atm) is a unit of pressure equal to 101.325 kPa (or 760 mmHg, 1013.25 millibars).
2. Absolute pressure (p_{abs}): is the pressure with its zero point set at the vacuum pressure.
3. Relative pressure (p_r): is the pressure with its zero set at the atmospheric pressure. It is more widely used in engineering than absolute pressure.

The relationship between them is

$$p_r = p_{abs} - p_a$$

The change of pressure within the fluid can be expressed as

$$dp = -\rho g dz$$

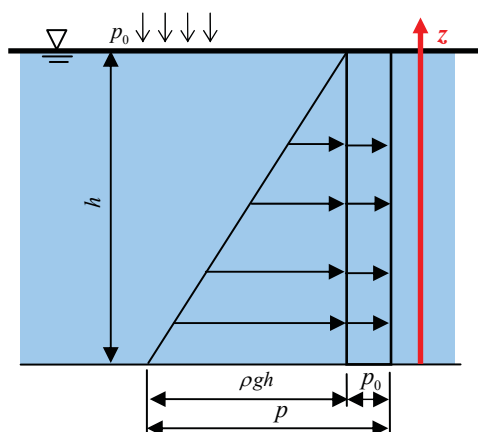

For a fluid with constant density, the differential formula can be integrated as

$$z + \frac{p}{\rho g} = C$$

where C is a constant that can be set from the boundary condition. If the top boundary pressure is p_0 and depth of the fluid is h , the bottom pressure can be derived as

$$p = \rho gh + p_0$$

For any two points in the same fluid, it can be derived

$$z_1 + \frac{p_1}{\rho g} = z_2 + \frac{p_2}{\rho g}$$

2.2 Manometer

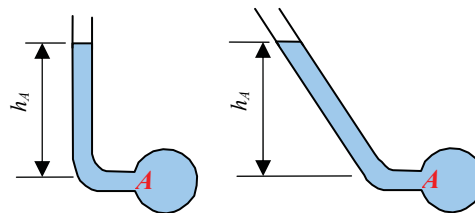

Simple manometers

A simple manometer is a tube with its one end attached to the fluid and the other one open to the atmosphere (also called *Piezometer*). The pressure at Point A can be derived from the height h_A in the tube.

$$p_A = \rho gh_A$$

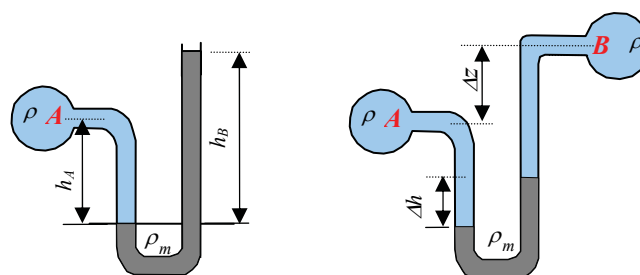

U-tube manometer

Differential manometer

A more complicated manometer uses U-tube with a different fluid to the measured one. The pressure at Point A will be

$$p_A = \rho_m gh_B - \rho gh_A$$

A differential manometer is used to measure the pressure difference between two points. A U-tube with mercury (or other fluids) is attached to two points whose pressures are to be measured. The pressure difference can be derived by measuring the elevation differences between Point A and Point B (i.e., Δz), and between the mercury levels (Δh).

Therefore

$$p_A - p_B = g[\rho_m - \rho)\Delta h + \rho\Delta z]$$

2.3 Pressure Force on Plane Surface

For a plane surface with area A , the total pressure force can be derived by the following integration formula:

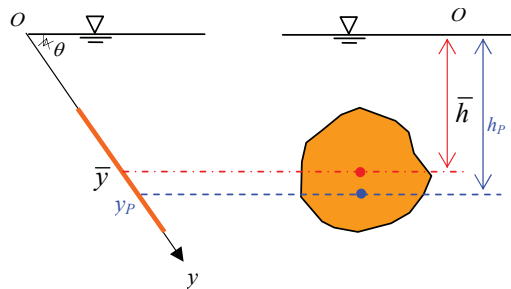

$$F = \int_A p dA = \int_A gh dA$$

where h is the depth of fluid from its surface.



STUDY AT A TOP RANKED INTERNATIONAL BUSINESS SCHOOL

Reach your full potential at the Stockholm School of Economics, in one of the most innovative cities in the world. The School is ranked by the Financial Times as the number one business school in the Nordic and Baltic countries.

Visit us at www.hhs.se





If the centroid of the area is known, the pressure force can be derived as

$$F = \rho g \bar{h} A$$

where \bar{h} is the depth of A 's centroid.

The centre of pressure is the point through which the resultant pressure acts.

$$y_P = \frac{\int y p dA}{\int p dA} = \frac{\int y^2 dA}{\int y dA}$$

The numerator is the moment of inertia of the surface about the axis through O , and it equals to $I_x = I_C + \bar{y}^2 A$. Therefore

$$y_P = \bar{y} + \frac{I_C}{\bar{y} A}$$

Shape	Area A	Centroid \bar{y}	Moment of Inertia I^c
Circle (r radius)	πr^2	r	$\pi r^4 / 4$
Rectangle (b width, h height)	bh	$h / 2$	$bh^3 / 12$
Triangle (b bottom width, h height)	$bh / 2$	$2h / 3$	$bh^3 / 36$

2.4 Pressure Force on Curved Surface

For curved surfaces, the pressure force is divided into horizontal and vertical components. The vertical force F_y is the total weight of the fluid above the curved surface and its centre of pressure acts through its centre of gravity. The horizontal force F_x equals to the pressure force on a vertical plane surface projected by the curved surface. The resultant force is a triangular combination of the horizontal and vertical parts.

$F_y = \rho gV$ where V is the volume of the fluid above the curved surface.

$$F = \sqrt{F_x^2 + F_y^2}$$

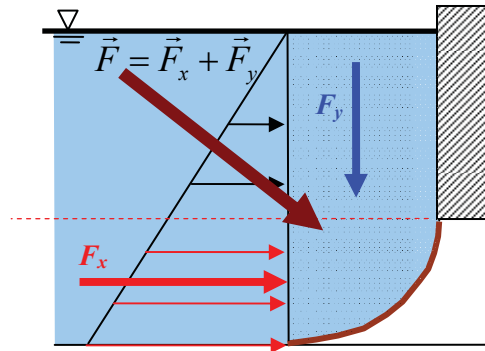

2.5 Flotation

1. Buoyancy

Buoyancy is the upward force on an object from the surrounding fluid (liquid or gas). This force is due to the pressure difference of the fluid at different parts of the object. The buoyancy force is derived by

$$F_B = \rho gV$$

where V is the displaced fluid volume by the object, ρ is the fluid density.

An object submerged in a fluid is subject to two forces: gravity and buoyancy. When gravity force is greater than buoyancy force, the object sinks to the bottom. If the situation is reversed, the object will float. If two forces equal to each other, the object could be anywhere in the fluid.

2. Stable flotation and metacentre

A floating object is stable if it tends to return to its original position after an angular displacement. This can be illustrated by the following example. When a vessel is tipped, the centre of buoyancy moves from C to C' . This is because the volume of displaced water to the left of G has been decreased while the volume of displaced water to the right is increased. The centre of buoyancy, being at the centre of gravity of the displaced water, moves to point C' , and a vertical line through this point passes G and intersects the original vertical at M . The distance \overline{GM} is known as the *metacentric height*. This illustrates the fundamental law of stability. *When M is above G , the metacentric height is positive and the floating body is stable, otherwise it is unstable.*

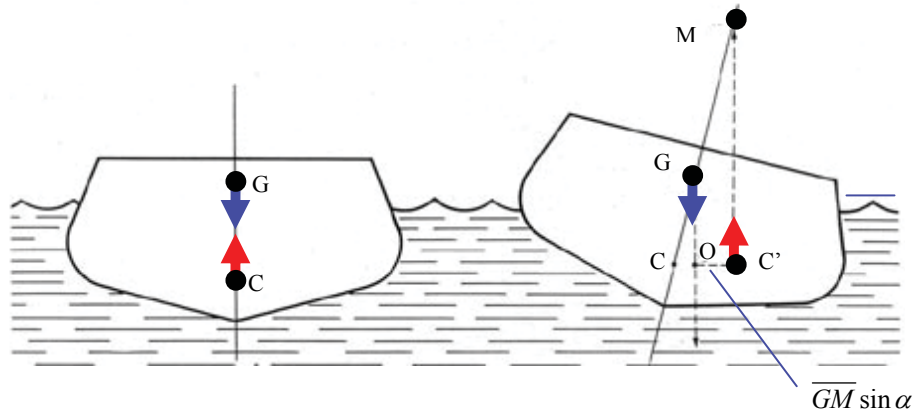

There are two ways to find the metacentre: experiment and analytical method.

- a) Metacentre by experiment (if a ship is already built, the experiment method is easy to apply)
Shift a known weight ω from the centre of the ship by a distance l to create a turning moment $P=\omega l$ and the ship (with a total weight of W) is tilted by an angle α . The metacentre can be derived by the balance of moments at the point G.

$$\overline{GM} = \frac{P}{W \sin \alpha} = \frac{\omega l}{W \sin \alpha} \approx \frac{\omega l}{W \alpha}$$

 [Click on the ad to read more](#)

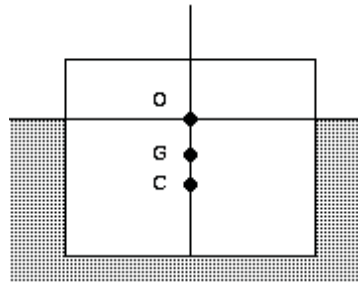

b) Metacentre by analytical method

Imagine the displacement centre (centroid of the buried body) is moved by x due to a turning moment. This centroid displacement is contributed from only the top two triangles (worked out one triangle and the other one is doing the same thing, with either added buoyancy and reduced buoyancy). If the ship's displacement volume is V , length is L and width is D , we can derive around C point the following,

$$Vx = 2 \int_0^{D/2} L(x \tan \alpha) x dx = (\tan \alpha) I_o, \text{ (} I_o \text{ is the 2}^{nd} \text{ moment of the area)}$$

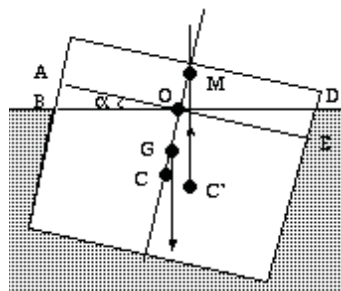

So $x = \frac{(\tan \alpha) I_o}{V}$

Therefore

$$\overline{CM} = \frac{x}{\tan \alpha} = \frac{I_o}{V}$$

From the centre of gravity and buoyancy,

$$\overline{GM} = \overline{CM} - \overline{CG}$$

Questions 2
Hydrostatics

1. A rectangular plate gate is placed in a water channel (density of water: 1000kg/m^3). Its width is 0.8m and the water depth is 2m . Estimate the pressure force and its centre of pressure

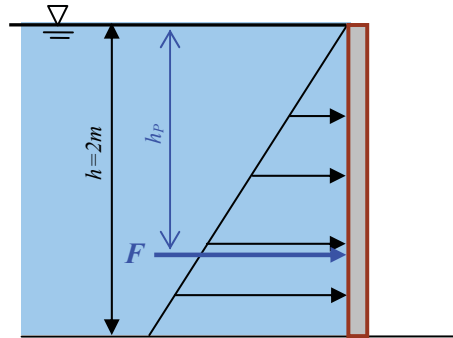

(Answer: 15.7 kN , 1.33 m)

2. Estimate the resultant force of water on a quadrant gate. Its radius is 1m and width 2m . The centre of gravity for the quarter circular sector is $4R/3\pi$ (from the circle centre to the right).

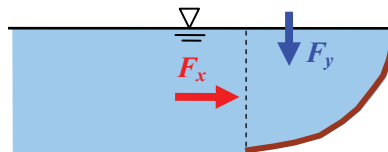

(Answer: 18.3 kN , 57.3°)

3. A cube of timber 1m on each side floats in water. The density of the timber is 600 kg/m^3 . Estimate the submerged depth of the cube.

(Answer: 0.6 m)

4. A crane barge which is rectangular in plan, has a large water plane area compared with its depth for stability. The barge weighs 500 kN and the crane 50 kN . The resulting centre of gravity of the combination is at the level of the deck, while the centre of gravity of the crane itself is 3m above the deck.

Tests are being undertaken to ensure the stability of the crane barge. The crane is moved horizontally sideways by 0.8 m and the barge rolls through an angle of 5° . What is the metacentric height of the system? When the crane is back in its central position, we need to know how high the jib can be raised before the barge becomes unstable.

(Answer: 0.834 m , 9.2m)

Solutions 2
 Hydrostatics

1. The centroid of the gate is

$$\bar{h} = \frac{h}{2} = \frac{2}{2} = 1 \text{ m}$$

The area is

$$A = bh = 0.8 \times 2 = 1.6 \text{ m}^2$$

Therefore

$$F = \rho g \bar{h} A = 1000 \times 9.81 \times 1 \times 1.6 = 15.7 \text{ kN}$$

The centre of pressure

$$I_c = \frac{bh^3}{12} = \frac{0.8 \times 2^3}{12} = 0.533 \text{ m}^4$$

The gate is vertical, so y and h are the same.

$$h_p = \bar{h} + \frac{I_c}{\bar{h}A} = 1 + \frac{0.533}{1 \times 1.6} = 1.33 \text{ m}$$

“I studied English for 16 years but...
...I finally learned to speak it in just six lessons”
Jane, Chinese architect



ENGLISH OUT THERE

Click to hear me talking before and after my unique course download



2. a) Vertical force

$$F_y = \rho g V = 1000 \times 9.81 \times \frac{\pi \times 1^2}{4} \times 2 = 15.4 \text{ kN}$$

Its centre of pressure is at

$$4R/3\pi = 0.424 \text{ m to the right of the circle centre.}$$

b) Horizontal force

The centroid for a vertical plane surface of 1m tall and 2 m wide is 0.5m

$$F_x = \rho g \bar{h} A = 1000 \times 9.81 \times 0.5 \times 2 = 9.81 \text{ kN}$$

Its centre of pressure is at 1/3 of the height

0.333m to the bottom.

c) Resultant force

$$F = \sqrt{F_x^2 + F_y^2} = \sqrt{15.4^2 + 9.81^2} = 18.3 \text{ kN}$$

Direction

$$\theta = \tan^{-1}(F_y / F_x) = \tan^{-1}(15.4/9.81) = 1.00(\text{radian}) = 57.3^\circ$$

It is 57.3° below the horizontal line and passes through the joint point between the vertical force line and horizontal force line..

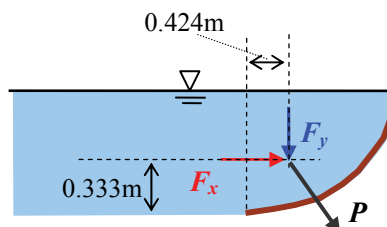

3. Weight of the cube

$$W = \rho_{wood} g V_{wood} = 600 \times 9.81 = 5886 N$$

The volume of water to be displaced is

$$V_{water} = \frac{W}{\rho_{water} g} = \frac{5886}{1000 \times 9.81} = 0.6 m^3$$

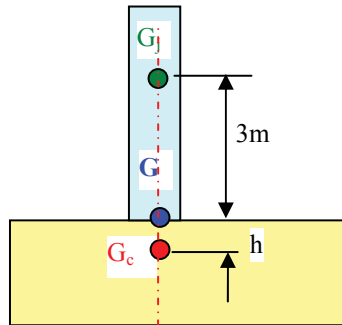

So the submerged depth will be

$$h = \frac{V_{water}}{Area} = \frac{0.6}{1 \times 1} = 0.6 m$$

4. This is to find the metacentre by experiment, so

$$\overline{GM} = \frac{\omega l}{W \sin \alpha} = \frac{50000 \times 0.8}{550000 \sin(5^\circ)} = 0.834 m$$

The metacentre is 0.834m above the deck.

The centre of gravity of the barge is

$$500h = 3 \times 50$$

$h = 0.3m$ (below the deck surface)

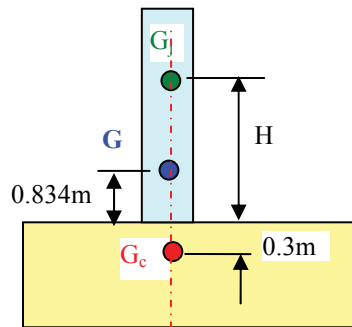

If the centre of jib gravity is up by H from the deck and the system centre of gravity moves by $0.834m$ above the deck

$$50 \times (H - 0.834) = 500 \times (0.3 + 0.834)$$

$$H = 12.2m$$

So it can move by

$$12.2 - 3 = 9.2m$$

Excellent Economics and Business programmes at:



university of groningen



“The perfect start of a successful, international career.”

CLICK HERE
to discover why both socially and academically the University of Groningen is one of the best places for a student to be

www.rug.nl/feb/education



3 Energy Equation

The energy equation is based on the conservation of energy, i.e., energy can be neither created nor destroyed.

3.1 Basic Formula

1. From solids

Total energy = kinetic energy + potential energy (unit: joule)

$$\text{Total energy} = \frac{mu^2}{2} + mgz$$

2. For fluids

In comparison with the solid mechanics, there is an extra energy term in fluids (*pressure*).

Total energy = kinetic + potential + pressure (unit: metre)

$$\text{i.e. } \frac{u^2}{2g} + z + \frac{p}{\rho g} \text{ (per unit weight)}$$

Pressure energy is similar to potential energy and they are closely linked ($z + p/\rho g = C$). One thing to be noticed is that in physics, energy unit is joule, but in hydraulics, engineers use meter and call it energy head. Unlike solid objects, fluid can move around and change its shape, so we use metre per unit fluid weight to describe the energy in fluid. One meter of energy head is equivalent of one joule energy of 1 Newton weight of fluid.

3. Energy equation and continuity equation

With the conservation of energy, the energy equation for one dimensional flow can be derived as

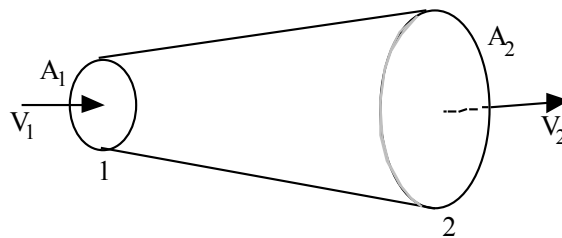

$$z_1 + \frac{p_1}{\rho g} + \frac{u_1^2}{2g} = z_2 + \frac{p_2}{\rho g} + \frac{u_2^2}{2g}$$

This is called the ***Bernoulli equation*** and it has been widely used in practical problems.

In addition to the energy equation, the conservation of mass is usually used jointly to solve fluid problems.

Rate of mass flow across 1 = Rate of mass flow across 2

$$\rho_1 A_1 u_1 = \rho_2 A_2 u_2$$

If ρ is constant

$$A_1 u_1 = A_2 u_2$$

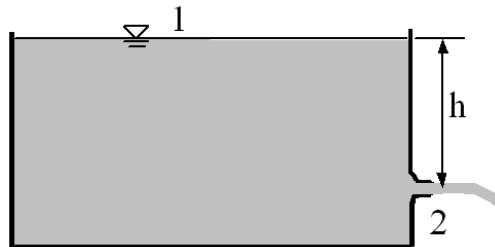

It is usually called the ***continuity equation***.

3.2 Applications

1) Example

A large tank with a well-rounded, small opening as an outlet. What is the velocity of a jet issuing from the tank (neglect the kinetic energy at section 1)?

Solution:

The energy equation for section 1 and 2

$$z_1 + \frac{p_1}{\rho g} + \frac{u_1^2}{2g} = z_2 + \frac{p_2}{\rho g} + \frac{u_2^2}{2g}$$

Use Section 2 as the datum, so

$$h + 0 + 0 = 0 + 0 + \frac{u_2^2}{2g}$$

Therefore

$$u_2 = \sqrt{2gh}$$

2) **Energy Loss and Gain**

In practice, some energy is ‘lost’ through friction (h_f), and external energy may be added by means of a pump or extracted by a turbine (E). The energy equation will be

$$z_1 + \frac{p_1}{\rho g} + \frac{u_1^2}{2g} + E = z_2 + \frac{p_2}{\rho g} + \frac{u_2^2}{2g} + h_f$$

3) **Venturi Meter**

is an instrument which may be used to measure discharge in pipelines. By measuring the difference in pressure, discharge may be made as (assume no energy loss)

$$z_1 + \frac{p_1}{\rho g} + \frac{u_1^2}{2g} = z_2 + \frac{p_2}{\rho g} + \frac{u_2^2}{2g}$$

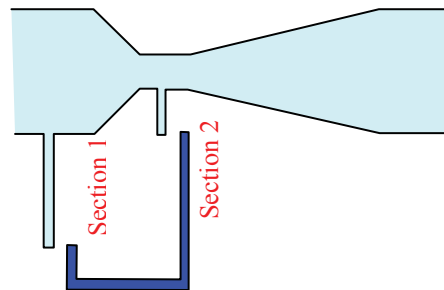



In the past four years we have drilled

89,000 km

That's more than **twice** around the world.

Who are we?
 We are the world's largest oilfield services company'.
 Working globally—often in remote and challenging locations—we invent, design, engineer, and apply technology to help our customers find and produce oil and gas safely.

Who are we looking for?
 Every year, we need thousands of graduates to begin dynamic careers in the following domains:

- **Engineering, Research and Operations**
- **Geoscience and Petrotechnical**
- **Commercial and Business**

What will you be?





*Based on Fortune 500 ranking 2011. Copyright © 2015 Schlumberger. All rights reserved.



i.e.

$$\frac{p_1}{\rho g} + \frac{u_1^2}{2g} = \frac{p_2}{\rho g} + \frac{u_2^2}{2g}$$

From the continuity equation

$$Q = A_1 u_1 = A_2 u_2$$

$$Q = \frac{A_1}{\sqrt{(A_1 / A_2)^2 - 1}} \sqrt{\frac{2(p_1 - p_2)}{\rho}}$$

The actual discharge will be slightly less than this due to the energy losses between Sections 1 and 2. A coefficient of discharge is introduced to take account of these energy losses.

$$Q_{\text{actual}} = C_d Q \text{ (} C_d \text{ values can be found in British Standard 1042 or other hydraulic handbooks)}$$

Orifice plate

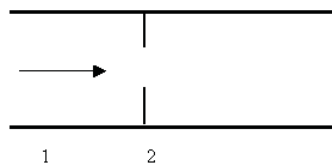

is similar to Venturi meter with compact size (hence more economical) but less accurate and more energy loss.

Questions 3
Energy Equation

- The device Pitot tube shown below is used to determine the velocity of liquid at point 1. It is a tube with its lower end directed upstream and its other leg vertical and open to the atmosphere. The impact of the liquid against Opening 1 forces liquid to rise in the vertical leg to the height Δz above the free surface. Determine the velocity at 1.

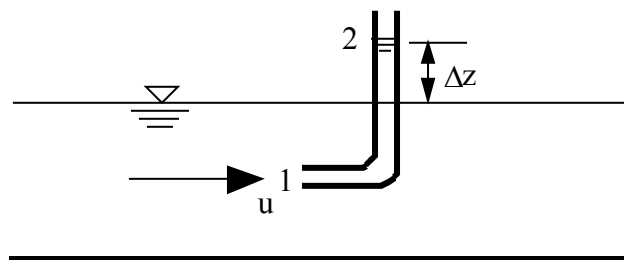

(Answer: $u = \sqrt{2g\Delta z}$)

2. What should the water level h be for the free jet just to clear the wall?

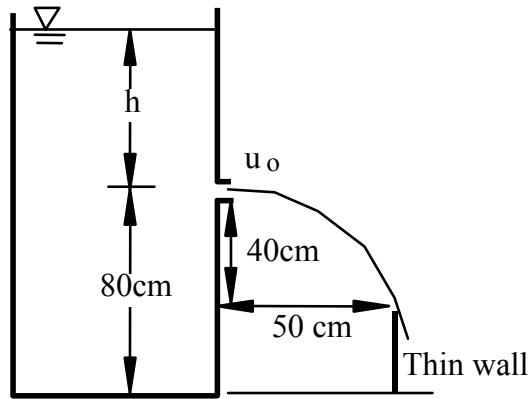

(Answer: 0.156 m)

3. If the velocity at Point A is 18m/s, what is the pressure at Point B if we neglect friction?

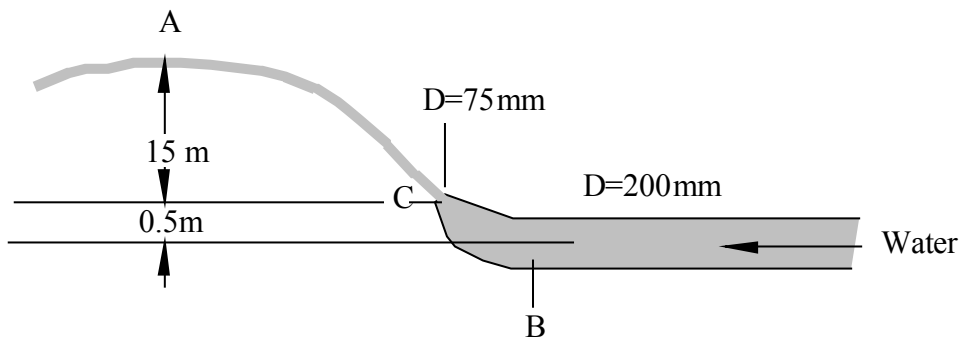

(Answer: 308KN/m²)

Solutions 3
Energy Equation

1. Kinetic energy at 1 is converted into Δz increase of the fluid at 2

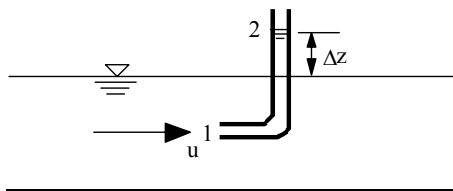

$$\frac{u_1^2}{2g} = \Delta z$$

hence

$$u_1 = \sqrt{2g\Delta z}$$

$$u_o = \sqrt{2gh}$$

Fall distance $gt^2/2 = 0.40$

So $t = 0.8944/\sqrt{g}$

Horizontal distance = $u_o t = (\sqrt{2gh})(0.8944/\sqrt{g}) = 0.50$

$$h = 0.156m$$

American online LIGS University

is currently enrolling in the
Interactive Online **BBA, MBA, MSc,**
DBA and PhD programs:

- ▶ enroll **by September 30th, 2014** and
- ▶ **save up to 16%** on the tuition!
- ▶ pay in 10 installments / 2 years
- ▶ Interactive **Online** education
- ▶ visit www.ligsuniversity.com to
find out more!

Note: LIGS University is not accredited by any nationally recognized accrediting agency listed by the US Secretary of Education. More info [here](#).



Click on the ad to read more

2. The energy equation between A-B

$$z_B + \frac{p_B}{\rho g} + \frac{V_B^2}{2g} = z_A + \frac{p_A}{\rho g} + \frac{V_A^2}{2g}$$

i.e.

$$0 + \frac{p_B}{\rho g} + \frac{V_B^2}{2g} = 15 + 0.5 + \frac{0}{\rho g} + \frac{18^2}{2g}$$

$$p_B / \rho = -0.5V_B^2 + 314.1$$

The energy equation between A-C,

$$z_c + \frac{p_c}{\rho g} + \frac{V_c^2}{2g} = z_A + \frac{p_A}{\rho g} + \frac{V_A^2}{2g}$$

i.e.

$$0 + \frac{0}{\rho g} + \frac{V_c^2}{2g} = 15 + \frac{0}{\rho g} + \frac{18^2}{2g}$$

$$V_c = 24.86 \text{ m/s}$$

4 Momentum Equation

4.1 The Principle

From Newton's 2nd law

$$\mathbf{F} = m\mathbf{a}$$

where $\mathbf{a} = \frac{\mathbf{V}_2 - \mathbf{V}_1}{\Delta t}$

So $\mathbf{F} = \frac{m(\mathbf{V}_2 - \mathbf{V}_1)}{\Delta t} = \frac{m}{\Delta t}(\mathbf{V}_2 - \mathbf{V}_1) = \rho Q(\mathbf{V}_2 - \mathbf{V}_1)$

where ρQV is the momentum, i.e. Momentum = Mass \times Velocity

It is important to note that momentum and velocity are both vectors.

Therefore, momentum force is a vector: $\vec{F} = \rho Q(\vec{u}_2 - \vec{u}_1)$

.....Alcatel-Lucent 

www.alcatel-lucent.com/careers

What if you could build your future and create the future?

One generation's transformation is the next's status quo. In the near future, people may soon think it's strange that devices ever had to be "plugged in." To obtain that status, there needs to be "The Shift".



It is more convenient to use scalar forms by separating the momentum force into three basic components:

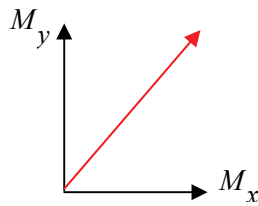

$$F_x = \rho Q(u_{2x} - u_{1x})$$

$$F_y = \rho Q(u_{2y} - u_{1y})$$

$$F_z = \rho Q(u_{2z} - u_{1z})$$

4.2 Applications

Two steps:

a) Calculating the total momentum force; b) find out where this force is sourced.

1) **A jet normal to a fixed plate**

Estimate F_R (the force exerted on the fluid by the plate)

Solution:

a) In the horizontal direction, the total momentum force is

$$-F = \rho Q(u_{2x} - u_{1x})$$

Here

$$u_{2x} = 0, u_{1x} = u, Q = Au$$

$$F = \rho Au^2$$

b) Since there is only one force F_R acting on the water jet, the total momentum force equals to F_R

$$F_R = F = \rho Au^2$$

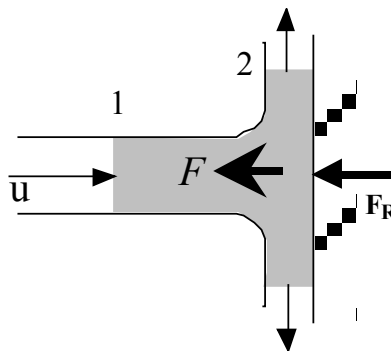

2) Force exerted by a nozzle

Calculate the force F_R required to hold a nozzle to the firehose for a discharge of 5 litre/second if the nozzle has an inlet diameter of 75 mm and an outlet diameter of 25 mm.

Solution:

- a) The total momentum force can be derived from

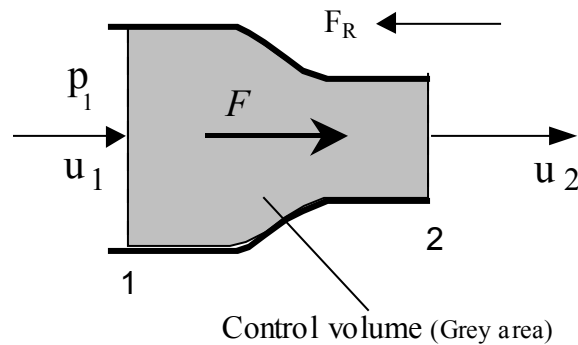

$$F = \rho Q(u_2 - u_1)$$

$$A_1 = \frac{\pi(0.075^2)}{4} = 4.42 \times 10^{-3} \text{ m}^2$$

$$A_2 = \frac{\pi(0.025^2)}{4} = 4.91 \times 10^{-4} \text{ m}^2$$

$$u_1 = Q / A_1 = 1.131 \text{ m/s}$$

$$u_2 = Q / A_2 = 10.18 \text{ m/s}$$

So the total momentum force on the fluid is

$$F = \rho Q(u_2 - u_1) = 1000 \times 0.005 \times (10.18 - 1.131) = 45.25 \text{ N}$$

- b)

Force balance

$$F = p_1 A_1 - F_R$$

From the energy equation

$$\frac{u_1^2}{2g} + \frac{p_1}{\rho g} = \frac{u_2^2}{2g} + \frac{p_2}{\rho g}$$

Therefore

$$p_1 = \frac{\rho(u_2^2 - u_1^2)}{2} = 51.2 \text{ kN} / \text{m}^2$$

Substitute into

$$F = p_1 A_1 - F_R$$

$$F_R = p_1 A_1 - F = 51.2 \times 4.42 - 45.25 = 181 \text{ N}$$

3. Two dimensional flow

Calculate the magnitude and direction of the force exerted by the pipe bend if the diameter is 600 mm, the discharge is 0.3m³/s and the pressure head at both end is 30m.

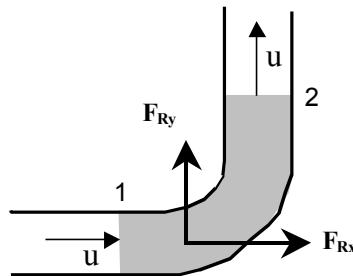

Join the best at
the Maastricht University
School of Business and
Economics!

Top master's programmes

- 33rd place Financial Times worldwide ranking: MSc International Business
- 1st place: MSc International Business
- 1st place: MSc Financial Economics
- 2nd place: MSc Management of Learning
- 2nd place: MSc Economics
- 2nd place: MSc Econometrics and Operations Research
- 2nd place: MSc Global Supply Chain Management and Change

Sources: Keuzegids Master ranking 2013; Elsevier 'Beste Studies' ranking 2012; Financial Times Global Masters in Management ranking 2012

Maastricht University is the best specialist university in the Netherlands (Elsevier)

Visit us and find out why we are the best!
Master's Open Day: 22 February 2014

www.mastersopenday.nl



Solution:

$$a) \quad A = \frac{\pi(0.6^2)}{4} = 0.283m^2$$

$$u = Q / A = 1.06m / s$$

So the total momentum force on the water

$$F_x = \rho Q(u_{2x} - u_{1x}) = \rho Q(0 - u) = -318N$$

$$F_y = \rho Q(u_{2y} - u_{1y}) = \rho Q(u - 0) = 318N$$

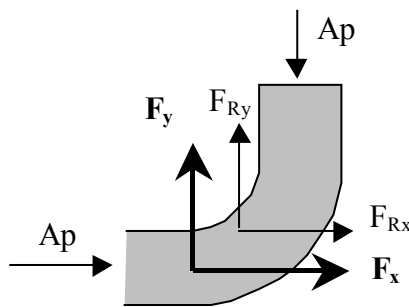

b) The total momentum force is a resultant force of pressure force and reaction force from the pipe.

$$F_x = F_{Rx} + Ap \quad \text{and} \quad F_y = F_{Ry} - Ap$$

$$F_{Rx} = F_x - Ap = -318 - 83202 = -83.52kN$$

$$F_{Ry} = F_y + Ap = 318 + 83202 = 83.53kN$$

So

$$F_R = \sqrt{F_{Rx}^2 + F_{Ry}^2} = 118.1kN$$

$$\text{and } \theta = \tan^{-1}(F_{Ry} / F_{Rx}) = 135^\circ$$

Questions 4
Momentum Equation

1. A small ingot and platform rest on a steady water jet. If the total weight supported is 825N, what is the jet velocity? Neglect energy losses.

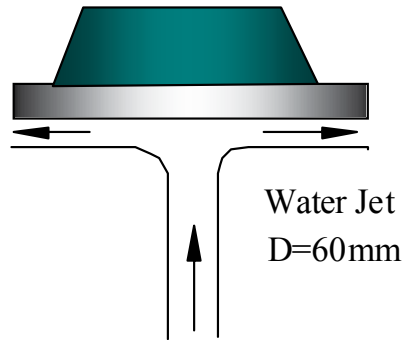

(Answer: 17.1m/s)

2. Calculate the magnitude and direction of the force exerted by the T-junction if the water discharges are $Q_1=0.3\text{m}^3/\text{s}$, $Q_2=0.15\text{m}^3/\text{s}$ and $Q_3=0.15\text{m}^3/\text{s}$, the diameters are $D_1=450\text{mm}$, $D_2=300\text{mm}$ and $D_3=200\text{mm}$, and the upstream pressure $p_1=500\text{kN}/\text{m}^2$. Neglect energy losses.

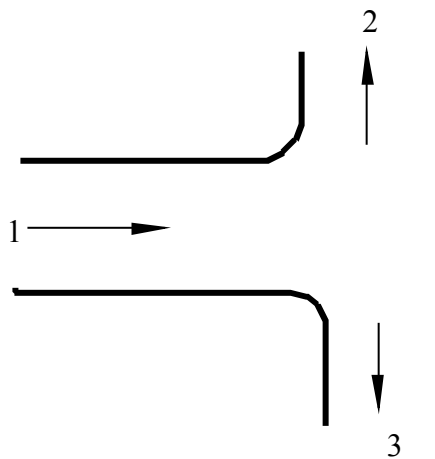

(Answer: 82.43kN, 166.3°)

3. A vertical jet of water leaves a nozzle at a speed of 10m/s and a diameter of 20mm. It suspends a plate having a mass of 1.5kg. What is the vertical distance h?

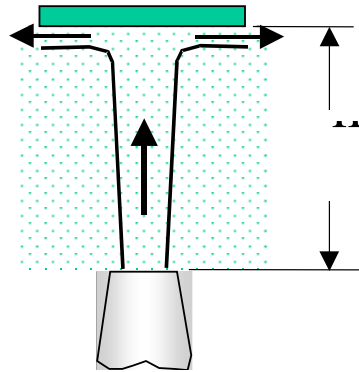

(Answer:3.98m)

Solutions 4
Momentum Equation

$$1. A = \frac{\pi 0.060^2}{4} = 2.826m^2$$

From the momentum equation

$$F = \rho Q(u_2 - u_1) = -\rho u_1 A u_1 = -2.826u_1^2$$

agence.cdg. © Photonistop



So

$$2.826u_1^2 = 825$$

$$u_1 = 17.1 \text{ m/s}$$

$$2. \quad A_1 = 0.159, \quad A_2 = 0.07065, \quad A_3 = 0.0314$$

$$u_1 = Q/A_1 = 1.886 \text{ m/s}, \quad u_2 = 2.123 \text{ m/s}, \quad u_3 = 4.775 \text{ m/s}$$

Pressure

$$\frac{p_1}{\rho g} + \frac{u_1^2}{2g} = \frac{p_2}{\rho g} + \frac{u_2^2}{2g} = \frac{p_3}{\rho g} + \frac{u_3^2}{2g}$$

$$p_2 = p_1 + \frac{\rho(u_1^2 - u_2^2)}{2} = 499.5 \text{ kN/m}^2$$

$$p_3 = p_1 + \frac{\rho(u_1^2 - u_3^2)}{2} = 490.4 \text{ kN/m}^2$$

The total external force

$$F_x = \rho(Q_2 u_{2x} + Q_3 u_{3x} - Q_1 u_{1x}) = -565.8 \text{ N}$$

$$F_y = \rho(Q_2 u_{2y} - Q_3 u_{3y} - Q_1 u_{1y}) = -397.8 \text{ N}$$

Reaction force

$$F_x = p_1 A_1 + F_{Rx}, \quad F_y = p_3 A_3 - p_2 A_2 + F_{Ry}$$

$$F_{Rx} = F_x - p_1 A_1 = -565.8 - 500 \times 159 = -80.1 \text{ kN},$$

$$F_{Ry} = F_y - p_3 A_3 + p_2 A_2 = -397.8 - 490.4 \times 31.4 + 499.4 \times 70.65 = 19.48 \text{ kN}$$

Hence

$$F_R = \sqrt{F_{Rx}^2 + F_{Ry}^2} = 82.43 \text{ kN}$$

$$\theta = \tan^{-1}(F_{Ry} / F_{Rx}) = 166.3^\circ$$

3. The required speed to suspend the plate

$$Q = VA = 10 \times 0.02^2 \pi / 4 = 0.00314m^3 / s$$

$$F_x = \rho Q(u_{2x} - u_{1x}) = -1000 \times 0.00314V = 1.5g$$

So

$$V = \frac{1.5g}{1000 \times 0.00314} = 4.69m / s$$

The energy equation

$$\frac{p_1}{\rho g} + z_1 + \frac{V_1^2}{2g} = \frac{p_2}{\rho g} + z_2 + \frac{V_2^2}{2g}$$

$$h = z_2 - z_1 = \frac{V_1^2}{2g} - \frac{V_2^2}{2g} = \frac{10^2 - 4.69^2}{2g} = 3.98m$$



Empowering People. Improving Business.

BI Norwegian Business School is one of Europe's largest business schools welcoming more than 20,000 students. Our programmes provide a stimulating and multi-cultural learning environment with an international outlook ultimately providing students with professional skills to meet the increasing needs of businesses.

BI offers four different two-year, full-time Master of Science (MSc) programmes that are taught entirely in English and have been designed to provide professional skills to meet the increasing need of businesses. The MSc programmes provide a stimulating and multi-cultural learning environment to give you the best platform to launch into your career.

- MSc in Business
- MSc in Financial Economics
- MSc in Strategic Marketing Management
- MSc in Leadership and Organisational Psychology

BI NORWEGIAN BUSINESS SCHOOL

EFMD **EQUIS ACCREDITED**

www.bi.edu/master



5 Pipe Flow

5.1 Introduction

Pipes are widely used in engineering to deliver fluid from one place to another. There are two flow types.

Laminar: flow in discrete layers with no mixing

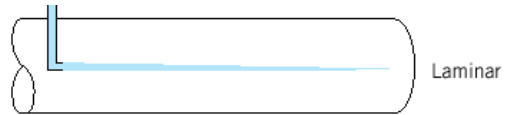

Turbulent: flow with eddying or mixing action.



Reynolds Number is used to predict the laminar/turbulent flows

$$Re = \frac{\rho DV}{\mu}$$

The Reynolds number represents a ratio of forces

- Re < 2000, laminar,
- Re > 4000, turbulent,
- 2000 < Re < 4000, transition region

Velocity distribution in laminar flow

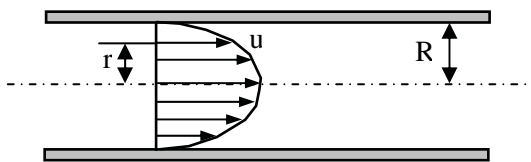

$$u = u_{\max} \left(1 - \frac{r^2}{R^2} \right), \text{ where } u_{\max} = 2\bar{u}$$

Velocity distribution in turbulent flow

$$u = u_{\max} \left(1 - \frac{r}{R} \right)^{1/7}, \text{ where } u_{\max} = 1.23\bar{u}$$

Mean velocity

$$V = \bar{u} = \frac{Q}{A} = \frac{\int u dA}{A}$$

The energy and momentum equations may then be rewritten in terms of the mean velocity

$$\frac{\alpha V^2}{2g} \quad \text{and} \quad F = \rho Q \beta (V_2 - V_1)$$

In most pipe flow, $\alpha = 1.06$ and $\beta = 1.02$ both may safely be ignored in practice.

5.2 Energy losses in pipe flow

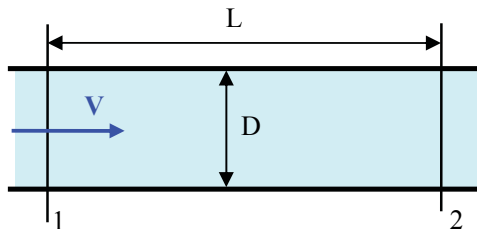

Darcy-Weisbach equation

where h_f is the energy head loss, L is the pipe length, D is the diameter and V is the mean velocity.

The friction factor λ is dimensionless and can be derived by experiments or from the following chart or formulas.

For laminar flow

$$\lambda = \frac{64}{Re}$$

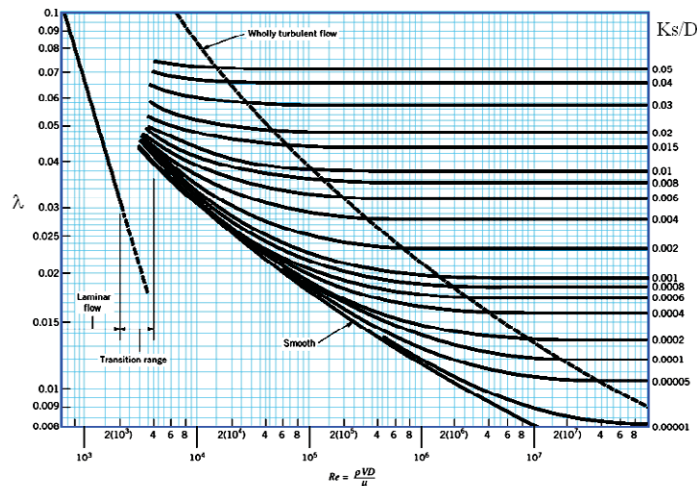

For turbulent flow (Colebrook-White formula)

$$\frac{1}{\sqrt{\lambda}} = -2 \log \left(\frac{k_s}{3.7D} + \frac{2.51}{\text{Re} \sqrt{\lambda}} \right)$$

K_s is the roughness factor

Typical K_s values (in mm)

brass, copper, glass	0.003
plastic	0.03
galvanised iron	0.15

Example

Oil flows through a 25 mm diameter pipe with a mean velocity of 0.3 m/s. Given that $\mu = 4.8 \times 10^{-2}$ kg/ms and $\rho = 800$ kg/m³, calculate (a) the pressure drop in a 45 m length and the maximum velocity, and (b) the velocity 5mm from the pipe wall.

Solution:

- 1) Check if the flow is laminar or turbulent

$$\text{Re} = \rho DV / \mu = 800 \times 0.025 \times 0.3 / (4.8 \times 10^{-2}) = 125 < 2000$$

So it is laminar flow

- 2) Pressure drop

$$\lambda = \frac{64}{\text{Re}} = 64 / 125 = 0.512$$

$$h_f = L \frac{\lambda V^2}{D 2g} = \frac{0.512 \times 45 \times 0.3^2}{0.025 \times 2g} = 4.23 \text{ m (of oil)}$$

or convert it into kN/m²

$$\rho g h_f = 33.2 \text{ kN} / \text{m}^2$$

3) Velocity

$$u_{\max} = 2V = 0.6 \text{ m/s}$$

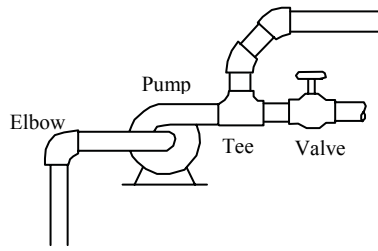

$$\text{From } \frac{u}{u_{\max}} = 1 - \left(\frac{r}{R}\right)^2 \text{ so } \frac{u}{0.6} = 1 - \left(\frac{12.5 - 5}{125}\right)^2$$

$$u = 0.384 \text{ m/s}$$

Need help with your dissertation?

Get in-depth feedback & advice from experts in your topic area. Find out what you can do to improve the quality of your dissertation!

Get Help Now



Go to www.helpmyassignment.co.uk for more info



Click on the ad to read more

5.3 Local losses (or Minor losses)

Local losses occur at pipe bends, junctions and valves, etc.

$$h_L = K_L \frac{V^2}{2g}$$

where h_L is the local head loss and K_L is a loss factor for a particular fitting (usually derived from experiments). V is the mean flow velocity before or after the pipe fitting (use the higher value if they are different).

The energy equation for a complete pipe with fittings will be

$$z_1 + \frac{p_1}{\rho g} + \frac{V_1^2}{2g} = z_2 + \frac{p_2}{\rho g} + \frac{V_2^2}{2g} + h_f + h_L$$

5.4 Grade Line

Hydraulic grade lines: A line that represents the potential energy and pressure energy in the fluid.

$$z + \frac{p}{\rho g}$$

When a hydraulic grade line is below the pipeline, the pressure in the pipe is less than the atmospheric pressure (negative pressure).

Energy grade lines: A line that represents the total energy in the fluid.

$$z + \frac{p}{\rho g} + \frac{V^2}{2g}$$

It is always vertically above the hydraulic grade line by a distance of $\frac{V^2}{2g}$.

5.5 Combination of pipes

1) Pipes in series

Two or more pipes of different sizes or roughnesses are so connected that fluid flows through one pipe and then through the others in turn.

$$H = \sum local\ loss + h_{f1} + h_{f2}$$

$$Q_1 = Q_2$$

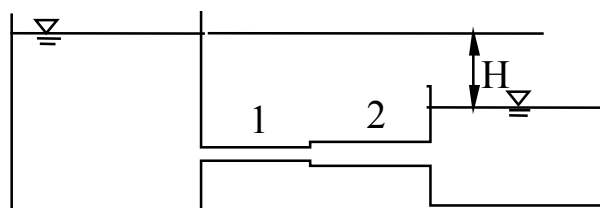

2) **Pipes in parallel**

The flow is divided among the pipes and then is joined again.

$$Q = Q_1 + Q_2 + Q_3$$

Energy loss in pipe 1 = Energy loss in pipe 2 = ...

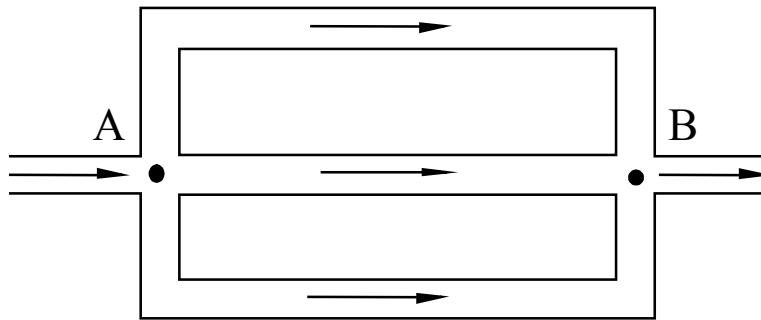

3) **Networks of Pipes**

Problems on networks of pipes in general are complicated and require trial solutions in which the elementary circuits are balanced in turn until all conditions for the flow are satisfied.

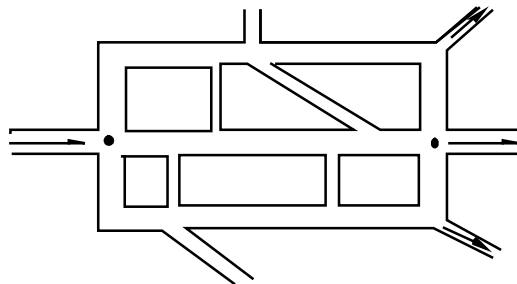

5.6 Energy Loss in Non-circular Pipes

The Darcy-Weisbach equation for circular pipes can also be used by replacing diameter D with hydraulic radius R .

$$h_f = \lambda \frac{L}{4R} \frac{V^2}{2g}$$

where

$$R = \frac{Area}{Perimeter}$$

It can be applied to square, oval, triangular, and similar types of sections.

Questions 5

Pipe Flow

1. In the laminar flow of a fluid in a circular pipe, the velocity profile is exactly a true parabola. The discharge is then represented by the volume of a paraboloid. Prove that for this case the ratio of the mean velocity to the maximum velocity is 0.5. (Note: $u = u_{\max} \left[1 - (r/R)^2 \right]$)
2. An oil ($\rho=868.5 \text{ kg/m}^3$ and $\mu=0.0814 \text{ kg/ms}$) is to flow through a 300m level concrete pipe. What size pipe will carry $0.0142\text{m}^3/\text{s}$ with a pressure drop due to friction of 23.94kPa?

(Answer: 155 mm)

3. Water flows at a rate of $0.04\text{m}^3/\text{s}$ in a 0.12-m-diameter horizontal pipe that contains a sudden contraction to a 0.06-m-diameter pipe ($K_L=0.40$). Determine the pressure drop across the contraction section. How much of this pressure difference is due to energy losses and how much is due to kinetic energy change?

(Answer: 133.9 kPa , 40.0 kPa, 93.9kPa)



Brain power

By 2020, wind could provide one-tenth of our planet's electricity needs. Already today, SKF's innovative know-how is crucial to running a large proportion of the world's wind turbines.

Up to 25 % of the generating costs relate to maintenance. These can be reduced dramatically thanks to our systems for on-line condition monitoring and automatic lubrication. We help make it more economical to create cleaner, cheaper energy out of thin air.

By sharing our experience, expertise, and creativity, industries can boost performance beyond expectations. Therefore we need the best employees who can meet this challenge!

The Power of Knowledge Engineering

Plug into The Power of Knowledge Engineering.
Visit us at www.skf.com/knowledge

SKF

4. If $H = 11m$, find the discharge through pipes 1, 2, and 3 (Neglect local losses).

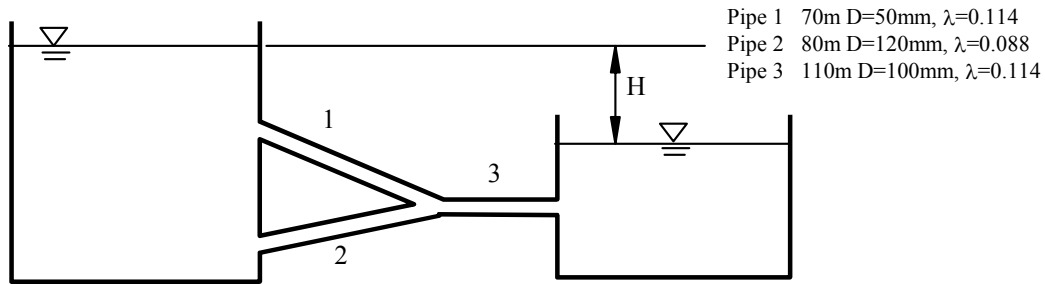

Pipe 1 70m D=50mm, $\lambda=0.114$
 Pipe 2 80m D=120mm, $\lambda=0.088$
 Pipe 3 110m D=100mm, $\lambda=0.114$

(Answer: 0.0009, 0.00856, 0.00946 m^3/s)

Solutions 5
Pipe Flow

1.

$$Q = \int u dA = \int_0^R u_{\max} \left[1 - \frac{r^2}{R^2} \right] 2\pi r dr = u_{\max} \left(\frac{\pi R^2}{2} \right)$$

$$V = \frac{Q}{A} = \frac{u_{\max} \pi R^2 / 2}{\pi R^2} = 0.5 u_{\max}$$

Thus $V / u_{\max} = 0.5$

2.

$$h_f = \frac{p}{\rho g} = \frac{23940}{868.5 \times 9.81} = 2.81m$$

Trial 1: $V=1$ m/s, from, $Q = AV = \frac{D^2 \pi}{4} V = 0.0142$, $D = \sqrt{0.0181 / V} = 0.135m$

$$Re = \frac{\rho DV}{\mu} = \frac{868.5 \times 1 \times 0.135}{0.0814} = 1440 \text{ (laminar)}$$

$$\lambda = \frac{64}{Re} = 0.0444 \text{ and } h_f = \lambda \frac{L V^2}{D 2g} = 5.03m \text{ too high,}$$

Sub h_f with 2.81 m to estimate V. $h_f = \lambda \frac{L V^2}{D 2g} = 2.81m$

i.e. $0.044 \frac{300 V^2}{0.135 2g} = 2.81m$

$$V = 0.751m/s$$

$$\text{Trial 2 } V=0.751 \text{ m/s so } D = \sqrt{0.0181/V} = 0.155\text{m}$$

$$\text{Re} = \frac{\rho DV}{\mu} = \frac{868.5 \times 0.751 \times 0.155}{0.0814} = 1242 \text{ (laminar)}$$

$$\lambda = \frac{64}{\text{Re}} = 0.0515 \text{ so } h_f = \lambda \frac{L}{D} \frac{V^2}{2g} = 2.87\text{m close to } 2.81 \text{ m}$$

Hence a pipe diameter of 0.155m would be required.

3. From energy equation

$$\frac{p_1}{\rho g} + z_1 + \frac{V_1^2}{2g} = \frac{p_2}{\rho g} + z_2 + \frac{V_2^2}{2g} + K_L \frac{V_2^2}{2g}$$

So

$$\frac{p_1 - p_2}{\rho g} = \frac{V_2^2 - V_1^2}{2g} + K_L \frac{V_2^2}{2g}$$

$$V_1 = \frac{0.04}{0.12^2 \pi / 4} = 3.54\text{m/s}$$

$$V_2 = \frac{0.04}{0.06^2 \pi / 4} = 14.15\text{m/s}$$

$$\begin{aligned} \frac{p_1 - p_2}{\rho g} &= \frac{V_2^2 - V_1^2}{2g} + K_L \frac{V_2^2}{2g} = \frac{14.15^2 - 3.54^2}{2g} + 0.4 \frac{14.15^2}{2g} \\ &= 9.57 + 4.08 = 13.65\text{m} \end{aligned}$$

$$p_1 - p_2 = 93.9 + 40.0 = 133.9\text{kPa}$$

This represents a 40.0 kPa drop from energy losses and a 93.9kPa drop due to an increase in kinetic energy.

$$4. \quad V_1 = \frac{Q_1}{A_1} = \frac{Q_1}{\pi 0.025^2} = 509.6Q_1, \quad V_2 = \frac{Q_2}{A_2} = \frac{Q_2}{\pi 0.06^2} = 88.5Q_2, \quad V_3 = \frac{Q_3}{A_3} = \frac{Q_3}{\pi 0.05^2} = 127.4Q_3$$

$$h_{f1} = h_{f2}$$

i.e.

$$\lambda_1 \frac{L_1}{D_1} \frac{V_1^2}{2g} = \lambda_2 \frac{L_2}{D_2} \frac{V_2^2}{2g}$$

So

$$0.114 \frac{70}{0.05} \frac{(509.6 Q_1)^2}{2g} = 0.088 \frac{80}{0.12} \frac{(88.5 Q_2)^2}{2g}$$

$$Q_1 = 0.105 Q_2$$

$$Q_3 = Q_1 + Q_2 = 1.105 Q_2$$

$$11 = \lambda_2 \frac{L_2}{D_2} \frac{V_2^2}{2g} + \lambda_3 \frac{L_3}{D_3} \frac{V_3^2}{2g}$$

$$11 = 0.088 \frac{80}{0.12} \frac{(88.5 Q_2)^2}{2g} + 0.114 \frac{110}{0.1} \frac{(127.4 Q_3)^2}{2g},$$

$$\text{or } 11 = 0.088 \frac{80}{0.12} \frac{(88.5 Q_2)^2}{2g} + 0.114 \frac{110}{0.1} \frac{(127.4 \times 1.105 Q_2)^2}{2g}$$

$$Q_2 = 0.00856 \text{ m}^3 / \text{s}, \quad Q_1 = 0.105 Q_2 = 0.0009 \text{ m}^3 / \text{s}, \quad Q_3 = 1.105 Q_2 = 0.00946 \text{ m}^3 / \text{s}$$

What do you want to do?

No matter what you want out of your future career, an employer with a broad range of operations in a load of countries will always be the ticket. Working within the Volvo Group means more than 100,000 friends and colleagues in more than 185 countries all over the world. We offer graduates great career opportunities – check out the Career section at our web site www.volvogroup.com. We look forward to getting to know you!

VOLVO
 AB Volvo (publ)
www.volvogroup.com

VOLVO TRUCKS | RENAULT TRUCKS | MACK TRUCKS | VOLVO BUSES | VOLVO CONSTRUCTION EQUIPMENT | VOLVO PENTA | VOLVO AERO | VOLVO IT
 VOLVO FINANCIAL SERVICES | VOLVO 3P | VOLVO POWERTRAIN | VOLVO PARTS | VOLVO TECHNOLOGY | VOLVO LOGISTICS | BUSINESS AREA ASIA



6 Physical Modelling

6.1 Background

Hydraulic modelling includes physical and mathematical models. Initially, due to a lack of computing power, physical models dominated the hydraulic modelling field. Froude (1870) established the famous Froude similarity when he was testing a ship model. In 1885, Reynolds built a river model for Mersey based on the Froude similarity. The Buckingham's Pi theorem (by J. Buckingham in 1914) extended the similarity principle to a broader sense. Since then, physical models have been widely used in hydraulics, including complex 3D river models with sediments.

With the advent of computers, mathematical modelling has been gaining popularity. It is possible to solve complicated differential equations using numerical techniques due to modern computer's large memory and CPU speed. Nowadays, mathematical models are highly accurate and efficient to tackle 1D river problems. They are cheaper to build and fast to run in comparison with physical models. In 2D modelling, mathematical models are gaining ground from physical models. However, for 3D modelling, physical models still have superior performance in many complicated problems and it would be a long time before mathematical models are able to totally replace them.

6.2 Dimensional Analysis

Dimensional Analysis is a branch of applied mathematics for investigating the form of a physical relationship. Dimensional Analysis not only helps us to design experiments but also allows us to gain an insight into how all the factors depend on each other even before we start experimenting.

Example:

A thin rectangular plate having a width w and a height h is located so that it is normal to a moving stream of fluid. Assume the drag D , that the fluid exerts on the plate is a function of w , h , the fluid viscosity μ and density ρ , and the velocity V of the fluid approaching the plate. Perform a dimensional analysis of this problem.

Basic steps:

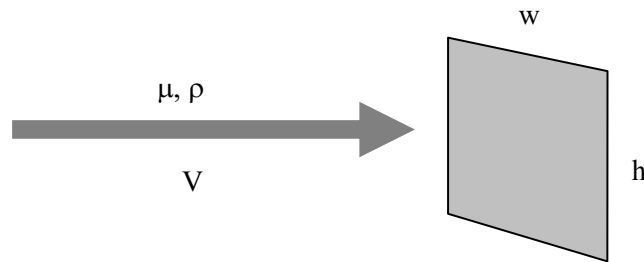

1. Decide variables to be used

$$D = f(w, h, \mu, \rho, V)$$

2. Express each of the variables in terms of basic dimensions mass M , length L and time T (or force F , L , T)

$$w \doteq L, h \doteq L, \mu \doteq ML^{-1}T^{-1} \quad (\doteq \text{ dimensionally equal to})$$

$$\rho \doteq ML^{-3}, V \doteq LT^{-1}, D \doteq MLT^{-2}$$

3. Determine the required number of Π terms (free variables)

Buckingham Π theorem: the number of Π terms (free variable) is equal to $k-r$, where k is the total number of variables in the problem and r is the number of reference dimensions (up to 3).

$$k-r = 6-3=3 \quad \text{so we have three free variables}$$

4. Select dependent variables,

Select w, V and ρ as dependent variables (Avoid choosing both w and h since they have the same dimension). The rest are free variables (D, μ, h).

5. Form a Π term by grouping one of the free variables with all dependent variables,

Starting with the free variable, D , the first Π term can be formed by combining D with the dependent variables such that

$$\Pi_1 = Dw^a V^b \rho^c$$

Estimate a, b, c so that the combination is dimensionless

$$(MLT^{-2})(L)^a (LT^{-1})^b (ML^{-3})^c \doteq M^0 L^0 T^0$$

So

$$1+c=0 \quad (\text{for } M)$$

$$1+a+b-3c=0 \quad (\text{for } L)$$

$$-2-b=0 \quad (\text{for } T)$$

Therefore

$a = -2, b = -2, c = -1$, the Π term then becomes

$$\Pi_1 = \frac{D}{w^2 V^2 \rho}$$

6. Repeat step 5 for each of the remaining free variables,

$$\Pi_2 = h w^a V^b \rho^c, \text{ and } a=-1, b=0, c=0$$

So $\Pi_2 = h / w$

And

$$\Pi_3 = \mu w^a V^b \rho^c, \text{ and } a=-1, b=-1, c=-1$$

So $\Pi_3 = \frac{\mu}{w V \rho}$

gaiteye
Challenge the way we run

**EXPERIENCE THE POWER OF
FULL ENGAGEMENT...**

**RUN FASTER.
RUN LONGER..
RUN EASIER...**

**READ MORE & PRE-ORDER TODAY
WWW.GAITEYE.COM**

7. Check all the resulting Π terms to make sure they are dimensionless,

$$\Pi_2 = \frac{h}{w} \doteq \frac{L}{L} = L^0, \text{ the same for the other two}$$

8. Express the final form as a relationship among the Π terms

$$\frac{D}{w^2 V^2 \rho} = \phi\left(\frac{h}{w}, \frac{\mu}{wV\rho}\right)$$

Now, there are only three variables instead of six, which are much easier for experimental data analysis.

Dependent variables are also called repeating variables, and free variables are called nonrepeating ones.

6.3 Analysis of Experimental Data

Dimensional analysis can greatly reduce the number of experiments needed and improve the data processing efficiency.

1) One Π term

Example: Assume that the drag D , acting on a spherical particle that falls very slowly through a viscous fluid is a function of the particle diameter d , the particle velocity V , and the fluid viscosity μ . Determine how the drag depends on the particle velocity.

Solution:

$$D = f(d, V, \mu)$$

by dimensional analysis, only one Π , $\Pi_1 = \text{Constant}$

$$\Pi_1 = \frac{D}{\mu V d}$$

So

$$\frac{D}{\mu V d} = C$$

C was found by experiment $C=3\pi$, so

$$D = 3\pi\mu V d \text{ (Stoke law)}$$

Therefore, only one experiment is needed to solve this problem.

2) **Two Π terms**

$$\Pi_1 = \phi(\Pi_2)$$

For problems involving two Π terms, results of an experiment can be conveniently presented in a simple graph. The relationship between the two terms can be solved with curve fitting techniques (e.g., linear or nonlinear regression).

3) **Three Π terms or more**

$$\Pi_1 = \phi(\Pi_2, \Pi_3)$$

It is still possible represent three variable problems in 3D graphics. Mathematically, surface fitting is needed to solve the relationship among them. If more than three terms are involved, more complicated data mining techniques are needed (such as Artificial Neural Networks, Support Vector Machines, etc).

6.4 Model and Similarity

A model is a representation of a physical system that may be used to predict the behaviour of the system of interest.

As we know, any given problem can be described in terms of a set of Π terms as

$$\Pi_1 = \phi(\Pi_2, \Pi_3, \dots, \Pi_n)$$

For a model to represent such a system

$$\Pi_{1m} = \phi(\Pi_{2m}, \Pi_{3m}, \dots, \Pi_{nm})$$

Therefore

If $\Pi_{2m} = \Pi_2, \Pi_{3m} = \Pi_3, \dots, \Pi_{nm} = \Pi_n$ then $\Pi_1 = \Pi_{1m}$

This is the prediction equation and indicates that the measured value of obtained with the model will be equal to the corresponding for the prototype as long as other pi terms are equal.

In many hydraulic engineering problems, models are with free surfaces (rivers, estuaries etc). Force F is linked with length, velocity, viscosity, and gravity acceleration, hence $f(F, l, V, \rho, \mu, g) = 0$.

From which, dimensional analysis gives:

$$\frac{F}{\rho V^2 l^2} = f\left(\frac{\rho V l}{\mu}, \frac{V^2}{g l}\right) \text{ or } \frac{F}{\rho V^2 l^2} = f(\text{Re}, Fr),$$

where Reynolds number $\text{Re} = \frac{\rho V l}{\mu}$, Froude number $Fr = \frac{V}{\sqrt{g l}}$ (to be introduced in later chapters).

In practice, it is usually impossible to satisfy all the Π terms, so it is important to identify the dominant terms. The Froude number is very common in river modelling, which represents gravitational forces in dominance. Hence, the Froude numbers for the model and the real-world structure (prototype) should be the same.

Froude Number $Fr_p = Fr_m = V_p / \sqrt{g l_p} = V_m / \sqrt{g l_m}$, hence $V_m / V_p = \sqrt{l_m / l_p} = \sqrt{\lambda_L}$

Similarities

Geometric	Kinematic (velocity)	Dynamic (force)
$\frac{L_m}{L_p} = \lambda_L$	$\frac{V_m}{V_p} = \frac{L_m / T_m}{L_p / T_p} = \frac{\lambda_L}{\lambda_T} = \lambda_V$	$\frac{F_m}{F_p} = \frac{M_m a_m}{M_p a_p} = \frac{\rho_m L_m}{\rho_p L_p} \times \frac{\lambda_L}{\lambda_T^2} = \lambda_\rho \lambda_L^2 \left(\frac{\lambda_L}{\lambda_T}\right) = \lambda_\rho \lambda_L^2 \lambda_V^2$

This e-book
is made with
SetaPDF





SETASIGN

PDF components for PHP developers

www.setasign.com



Questions 6
Physical Modelling

1. Water flows over a dam as illustrated below. Assume the flow rate q (per unit length along the dam, hence with unit of m^2/s) depends on the head H , width b , acceleration of gravity g , fluid density ρ , and fluid viscosity μ . Develop a suitable set of dimensionless parameters for this problem using b , g , and ρ as repeating variables.

(Answer: $\frac{q}{b^{3/2}g^{1/2}} = \phi\left(\frac{H}{b}, \frac{\mu}{b^{3/2}g^{1/2}\rho}\right)$)

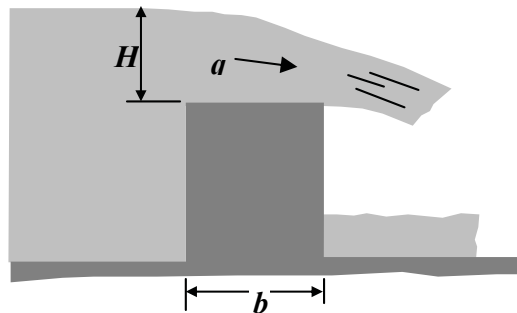

2. A 1:50 model of a boat has a wave resistance of 0.02N when operating in water at 1.0m/s. Find the corresponding prototype wave resistance. Find also the horsepower requirement for the prototype. What velocity does this test represent in the prototype? (use Froude criterion, 1Kilowatt = 1.34 Horsepower)

(Answer: 2500N, 23.7 hp, 7.07m/s)

Solutions 6
Physical Modelling

1.
 $q = f(H, b, g, \rho, \mu)$

$$q \doteq \frac{L^2}{T}, H \doteq \frac{L}{L}, b \doteq L, g \doteq \frac{L}{T^2}, \rho \doteq \frac{M}{L^3}, \mu \doteq ML^{-1}T^{-1}$$

Six variables, only three reference dimensions,

so $k-r = 6-3 = 3$, three Π terms

Repeating variables: b, g and ρ

$$\begin{aligned}\Pi_1 &= qb^a g^b \rho^c \doteq L^2 T^{-1} (L)^a (L T^{-2})^b (M L^{-3})^c = L^0 T^0 M^0 \\ 2 + a + b - 3c &= 0 \\ -1 - 2b &= 0 \\ c &= 0\end{aligned}$$

Therefore $c=0$; $b=-1/2$; $a = -3/2$

$$\text{So, } \Pi_1 = \frac{q}{b^{3/2} g^{1/2}}$$

$$\begin{aligned}\Pi_2 &= Hb^a g^b \rho^c \doteq L(L)^a (L T^{-2})^b (M L^{-3})^c = L^0 T^0 M^0 \\ 1 + a + b - 3c &= 0 \\ -2b &= 0 \\ c &= 0\end{aligned}$$

Therefore,

$$c=0; b=0; a=-1$$

$$\Pi_2 = \frac{H}{b}$$

$$\begin{aligned}\Pi_3 &= \mu b^a g^b \rho^c \doteq M L^{-1} T^{-1} (L)^a (L T^{-2})^b (M L^{-3})^c = L^0 T^0 M^0 \\ -1 + a + b - 3c &= 0 \\ -1 - 2b &= 0 \\ 1 + c &= 0\end{aligned}$$

Hence $c=-1$; $b=-1/2$; $a=-3/2$

$$\Pi_3 = \frac{\mu}{b^{3/2} g^{1/2} \rho}$$

$$\text{Therefore } \frac{q}{b^{3/2} g^{1/2}} = \phi\left(\frac{H}{b}, \frac{\mu}{b^{3/2} g^{1/2} \rho}\right)$$

2.

The geometric ratio is

$$\lambda_L = \frac{L_m}{L_p} = \frac{1}{50} = 0.02$$

From the Froude number

$$\text{Froude number } Fr_p = Fr_m = V_p / \sqrt{g l_p} = V_m / \sqrt{g l_m},$$

hence $\lambda_v = V_m / V_p = \sqrt{l_m / l_p} = \sqrt{\lambda_L} = \sqrt{0.02} = 0.1414$

The velocity of 1.0m/s in the model represents the prototype velocity

$$V_p = V_m / 0.1414 = 1 / 0.1414 = 7.07 \text{ m/s}$$

Dynamic (force) similarity can be derived as

$$F = \text{mass} \times \text{acceleration}$$

$$\frac{F_m}{F_p} = \frac{M_m a_m}{M_p a_p} = \frac{\rho_m L_m^3}{\rho_p L_p^3} \times \frac{L_m T_m^{-2}}{L_p T_p^{-2}} = \frac{\lambda_L^4}{\lambda_T^2} = \frac{0.02^4}{\lambda_T^2} \quad (\text{The fluid density is the same in both cases})$$

The time ratio can be derived from Kinematic (velocity) similarity

$$\frac{V_m}{V_p} = \frac{L_m / T_m}{L_p / T_p} = \frac{\lambda_L}{\lambda_T} = \lambda_v$$

www.sylvania.com

We do not reinvent the wheel we reinvent light.

Fascinating lighting offers an infinite spectrum of possibilities: Innovative technologies and new markets provide both opportunities and challenges. An environment in which your expertise is in high demand. Enjoy the supportive working atmosphere within our global group and benefit from international career paths. Implement sustainable ideas in close cooperation with other specialists and contribute to influencing our future. Come and join us in reinventing light every day.

Light is OSRAM

OSRAM SYLVANIA



Hence

$$\lambda_T = \frac{\lambda_L}{\lambda_V} = \frac{0.02}{0.1414} = 0.1414$$

So

$$F_p = \frac{\lambda_T^2}{0.02^4} F_m = \frac{0.1414^2}{0.02^4} 0.02 = 125000 \times 0.02 = 2500 N$$

The force ratio is

$$\lambda_F = \frac{F_m}{F_p} = \frac{1}{125000} = 8 \times 10^{-6}$$

From $Power = V \times F$

$$P_p = F_p V_p = 2500 \times 7.07 (\text{watt}) = 17.68 (\text{kilowatt}) = 23.67 \text{hp}$$



Discover the truth at www.deloitte.ca/careers

Deloitte.

© Deloitte & Touche LLP and affiliated entities.



Click on the ad to read more

7 Open Channel Flow

7.1 What is "Open Channel Flow"

Open channel flow is flow of liquid in a conduit in which the upper surface of the liquid is in contact with the atmosphere. The flows in the following cases are all open channel flow (include the one in the circular pipe).

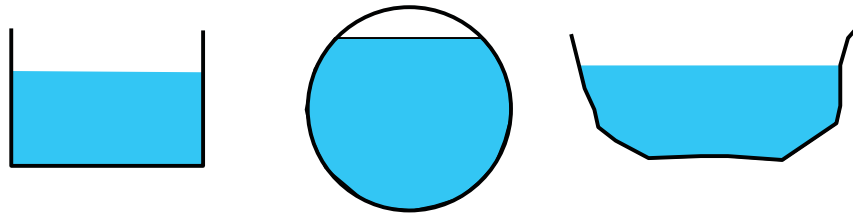

There are many types of open channel flow and a common classification system is as follows.

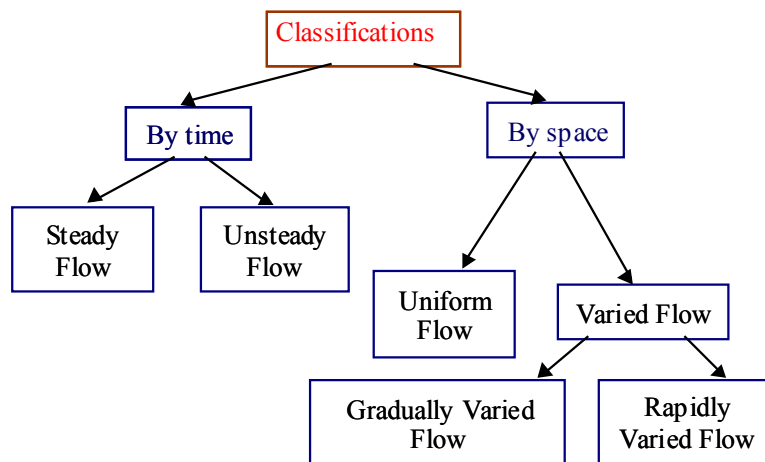

The uniform flow refers to flow whose water depth, width, flow area and velocity do not change with distance. If any of these factors change, the flow will be called varied flow (or nonuniform flow).

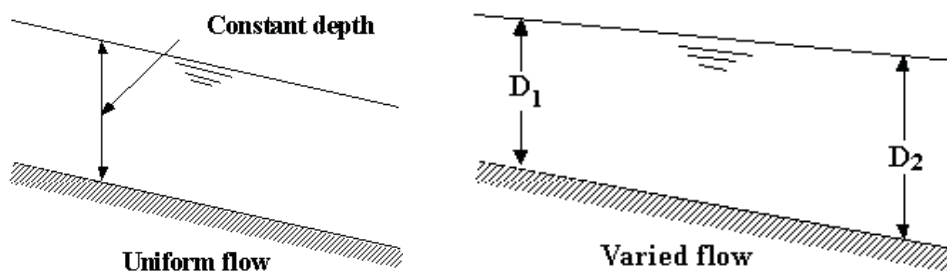

The steady flow refers to flow factors and variables that do not change with time, otherwise the flow will be called unsteady flow.

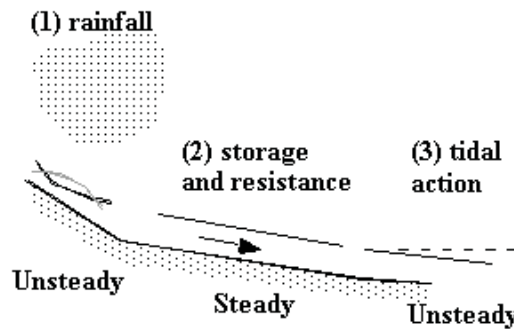

7.2 Channel Geometric Properties

The measurable geometric properties of channels are:

Depth (y), Area (A), Wetted perimeter (P), Surface width (B)

They are aggregated into two useful factors:

Hydraulic radius ($R=A/P$), Hydraulic mean depth ($Dm=A/B$)

	<p style="text-align: center;">Rectangle</p>	<p style="text-align: center;">Trapezoid</p>	<p style="text-align: center;">Circular</p>
A	by	$(b + xy)y$	$\frac{1}{8}(\phi - \sin \phi)D^2$
P	$b+2y$	$b + 2y\sqrt{1+x^2}$	$\frac{1}{2}\phi D$
B	b	$b + 2xy$	$\left(\sin \frac{\phi}{2}\right)D$
R	$\frac{by}{b + 2y}$	$\frac{(b + xy)y}{b + 2y\sqrt{1+x^2}}$	$\frac{1}{4}\left(1 - \frac{\sin \phi}{\phi}\right)D$
D m	y	$\frac{(b + xy)y}{b + 2xy}$	$\frac{1}{8}\left(\frac{\phi - \sin \phi}{\sin(\phi/2)}\right)D$

Irregular channels

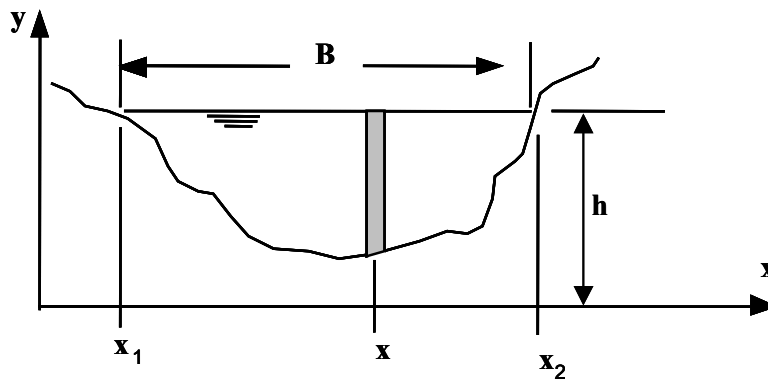

$$A = \int_{x_1}^{x_2} (h - y) dx \quad P = \int_{x_1}^{x_2} \sqrt{dx^2 + dy^2} = \int_{x_1}^{x_2} \sqrt{1 + y'^2} dx$$

In practice, the cross section is divided into a finite number of sections. A and P are the sum of those segments.

SIMPLY CLEVER

ŠKODA



We will turn your CV into an opportunity of a lifetime



Do you like cars? Would you like to be a part of a successful brand? We will appreciate and reward both your enthusiasm and talent. Send us your CV. You will be surprised where it can take you.

Send us your CV on www.employerforlife.com



Click on the ad to read more

7.3 Calculation of Hydraulic Radius and Hydraulic Mean Depth

Example 1: Rectangular channel

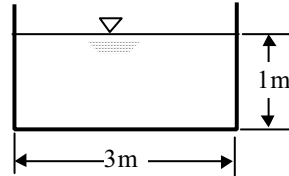

From $A = 3m^2, B = 3m, P = 1 + 1 + 3 = 5m$

So $R = 3/5 = 0.6m, D_m = 3/3 = 1m$

Example 2: Trapezoidal Channel

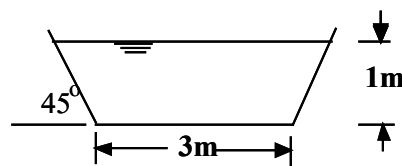

From $A = 4m^2, B = 5m, P = 5.83$

So $R = 4/5.83 = 0.686m, D_m = 4/5 = 0.8m$

Example 3: Circular Channel

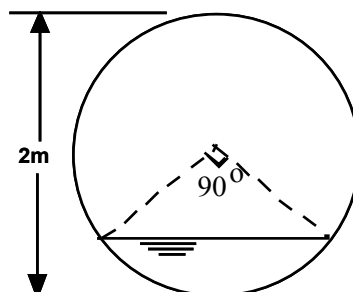

From $B = \sqrt{2} = 1.414m, P = 3.14/2 = 1.57m, A = 3.14/4 - 1/2 = 0.285m^2$

So $R = 0.285/1.57 = 0.182m, D_m = 0.285/1.414 = 0.202m$

Questions 7
Open Channel Flow

1. Compute the hydraulic radius and hydraulic mean depth for a trapezoidal channel.

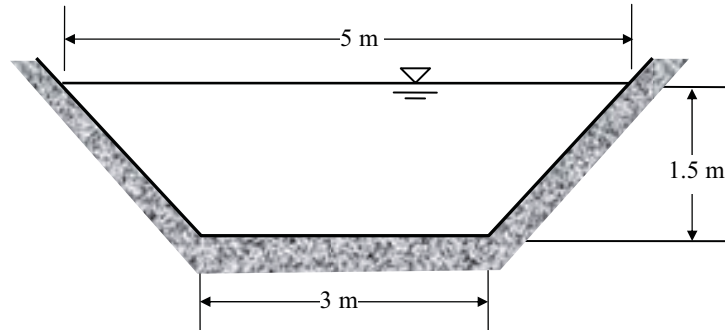

(Answer: 0.91m, 1.2m)

2. Compute the hydraulic radius and hydraulic mean depth for a smooth concrete-lined channel.

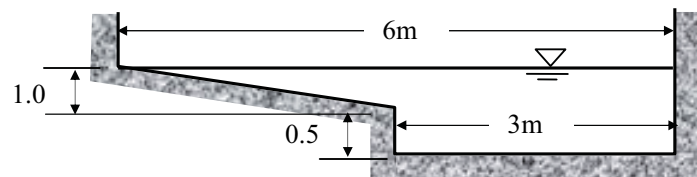

(Answer 0.735m, 1.0 m)

3. Derive equations for hydraulic radius and hydraulic mean depth for a parabolic channel. If $B=6\text{ m}$ and $h = 3\text{ m}$ for the channel, calculate its hydraulic radius and hydraulic mean depth.

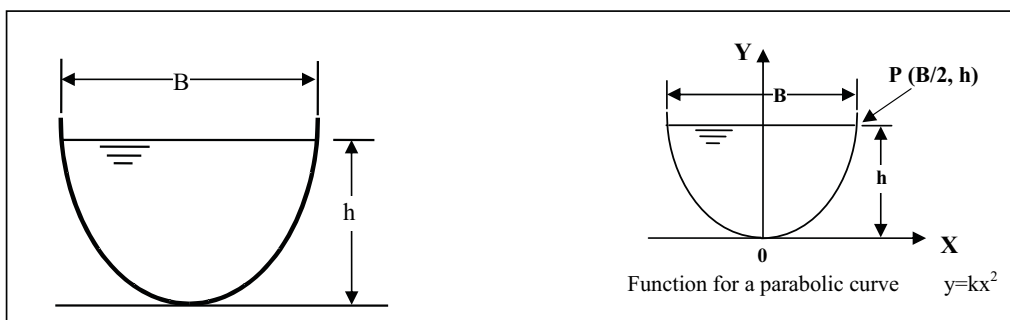

Note:

$$\int \sqrt{ax^2 + c} dx = \frac{x}{2} \sqrt{ax^2 + c} + \frac{c}{2\sqrt{a}} \ln(x\sqrt{a} + \sqrt{ax^2 + c})$$

(Answer 1.35m, 2.0 m)

Solutions 7
Open Channel Flow

$$1. \quad A = \frac{(5+3) \times 1.5}{2} = 6m^2$$

$$P = 3 + 2\sqrt{1+1.5^2} = 6.61m$$

Hydraulic radius $R = A/P = 6/6.61 = 0.91 \text{ m}$

$B = 5 \text{ m}$

Hydraulic mean depth $D_m = A/B = 6/5 = 1.2 \text{ m}$

$$2. \quad A = 3 \times 1.5 + \frac{1 \times 3}{2} = 6m^2$$

$$P = 3 + 1.5 + 0.5 + \sqrt{1+3^2} = 8.16m$$

$B = 6m$

Hydraulic radius $R = 6/8.16 = 0.735m$

Hydraulic mean depth $D_m = 6/6 = 1.0m$

I joined MITAS because
I wanted **real responsibility**

The Graduate Programme
for Engineers and Geoscientists
www.discovermitas.com



Month 16

I was a construction
supervisor in
the North Sea
advising and
helping foremen
solve problems

Real work
International opportunities
Three work placements



 **MAERSK**



Click on the ad to read more

3. Assume the parabolic curve function is $y=kx^2$

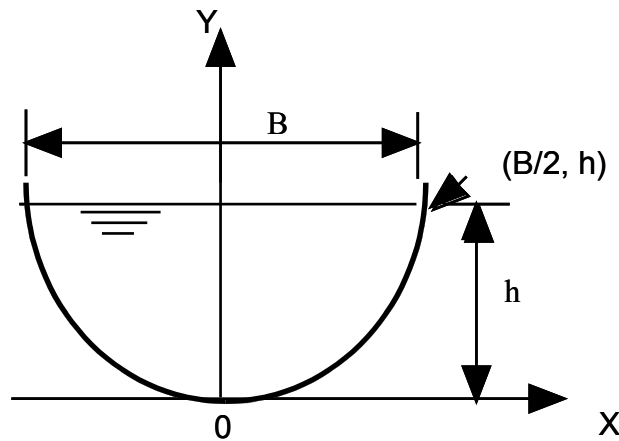

Replace (x,y) with (B/2,h)

So $k = 4h/B^2$

The following steps can be done either manually, or by Matlab (or Maple)

Method 1 (manual)

$$\begin{aligned} \text{Area } P &= \int_{-B/2}^{B/2} \sqrt{1+y'^2} dx = 2 \int_0^{B/2} \sqrt{1+y'^2} dx \\ A &= \int_{-B/2}^{B/2} (h-y) dx = \frac{2}{3} Bh \\ &= 2 \int_0^{B/2} \sqrt{1+(2kx)^2} dx \end{aligned}$$

Since $\int \sqrt{ax^2 + c} dx = \frac{x}{2} \sqrt{ax^2 + c} + \frac{c}{2\sqrt{a}} \ln(x\sqrt{a} + \sqrt{ax^2 + c})$

and let $s=(2k)^2$

$$\begin{aligned} P &= 2 \int_0^{B/2} \sqrt{1+sx^2} dx = 2 \left(\frac{x}{2} \sqrt{sx^2 + 1} + \frac{1}{2\sqrt{s}} \ln(x\sqrt{s} + \sqrt{sx^2 + 1}) \right) \Big|_0^{B/2} \\ &= \frac{B}{2} \sqrt{s \left(\frac{B}{2} \right)^2 + 1} + \frac{1}{\sqrt{s}} \ln \left(\frac{B\sqrt{s}}{2} + \sqrt{s \left(\frac{B}{2} \right)^2 + 1} \right) \end{aligned}$$

substitute s with $(2k)2$

$$\begin{aligned}
 P &= \frac{B}{2} \sqrt{(2k)^2 \left(\frac{B}{2}\right)^2 + 1} + \frac{1}{2k} \ln\left(\frac{2Bk}{2} + \sqrt{(2k)^2 \left(\frac{B}{2}\right)^2 + 1}\right) \\
 &= \frac{B}{2} \sqrt{(kB)^2 + 1} + \frac{1}{2k} \ln(kB + \sqrt{(kB)^2 + 1}) \\
 &= \frac{B}{2} \left[\sqrt{(kB)^2 + 1} + \frac{1}{kB} \ln(kB + \sqrt{(kB)^2 + 1}) \right]
 \end{aligned}$$

let $t = kB = 4h/B$, then

$$P = (B/2) [\sqrt{1+t^2} + 1/t \ln(t + \sqrt{1+t^2})]$$

Since

$$R = A/P$$

so equations for hydraulic radius and hydraulic mean depth are:

$$R = \frac{4h}{3[\sqrt{1+t^2} + 1/t \ln(t + \sqrt{1+t^2})]} \quad \text{where } t = \frac{4h}{B}$$

and

$$D_m = \frac{A}{B} = \frac{2h}{3}$$

When $B = 6$ and $h = 3$ then

$$\begin{aligned}
 t &= \frac{4h}{B} = \frac{4 \times 3}{6} = 2 \\
 R &= \frac{4h}{3[\sqrt{1+t^2} + 1/t \ln(t + \sqrt{1+t^2})]} = \frac{4 \times 3}{3[\sqrt{1+2^2} + \frac{1}{2} \ln(2 + \sqrt{1+2^2})]} \\
 &= \frac{4}{[\sqrt{5} + \frac{1}{2} \ln(2 + \sqrt{5})]} = \frac{4}{[2.236 + \frac{1}{2}(1.444)]} = 1.35m \\
 D_m &= \frac{2h}{3} = \frac{2 \times 3}{3} = 2m
 \end{aligned}$$

Method 2 : Matlab (it actually uses Maple as its symbolic engine hence you can also use Maple directly)

Write the following lines into openchannel.m, then run it:

%-- Matlab code for Open Channel Q3

syms x k h B

%-- curve equation

*k=4*h/B^2;*

*y=k*x^2;*

%- area A

A=int(h-y, -B/2, B/2);

% wetted perimeter

P=int((1+(diff(y))^2)^0.5, -B/2, B/2);

%-- hydraulic factor

R=A/P;

R=simple(R)

Dm=A/B

ie business school

#1 EUROPEAN BUSINESS SCHOOL
FINANCIAL TIMES 2013

#gobeyond

MASTER IN MANAGEMENT

Because achieving your dreams is your greatest challenge. IE Business School's Master in Management taught in English, Spanish or bilingually, trains young high performance professionals at the beginning of their career through an innovative and stimulating program that will help them reach their full potential.

- Choose your area of specialization.
- Customize your master through the different options offered.
- Global Immersion Weeks in locations such as London, Silicon Valley or Shanghai.

Because you change, we change with you.

www.ie.edu/master-management | mim.admissions@ie.edu |

%--- substitute values B=6, h=3

B=6;h=3;

eval(R)

eval(Dm)

Results:

R =

$$\frac{32 \cdot h^2 \cdot B}{(24 \cdot (B^2 + 16 \cdot h^2))^{1/2} \cdot h + 3 \cdot \log((h^2 \cdot 64^{1/2} + 2 \cdot ((B^2 + 16 \cdot h^2)/B^2)^{1/2}) \cdot B^3 \cdot (h^2/B^4)^{1/2}) / B^3 / (h^2/B^4)^{1/2}} \cdot B^2 - 3 \cdot \log((-h^2 \cdot 64^{1/2} + 2 \cdot ((B^2 + 16 \cdot h^2)/B^2)^{1/2}) \cdot B^3 \cdot (h^2/B^4)^{1/2}) / B^3 / (h^2/B^4)^{1/2}} \cdot B^2$$

$$Dm = 2/3 \cdot h$$

$$R = 1.3523$$

$$Dm = 2$$

8 Uniform Flow

8.1 Introduction

Definition: Water depth, width, flow area and velocity do not change with distance.

An important term in hydraulics is flow rate or discharge. It is defined as the volume of water that passes a particular reference point in a unit of time. Its common units are m^3/s or cumecs (other units: cfs, mgd, etc).

To understand how large $1\text{m}^3/\text{s}$ is, here is an example.

Example:

If the daily water consumption in Bristol is 300 liters/person, how many people would be provided with water by $1\text{ m}^3/\text{s}$ flow?

Solution:

$$1000 \times 24 \times 3600 (\text{l} / \text{day}) / 300 = 288,000$$

So it could supply water to 288,000 people in Bristol.

8.2 Laminar or Turbulent Flow

As in a pipe flow, the Reynolds Number (Re) can be used to identify laminar and turbulent flow state for open channels.

$$\text{Re} = \frac{\rho R V}{\mu}$$

where :

R	hydraulic radius (m)	ρ	density (kg/m^3), $1000\text{ kg}/\text{m}^3$
V	mean velocity (m/s)	μ	viscosity ($\text{kg}/\text{m s}$), about $1.14 \times 10^{-3}\text{ Ns}/\text{m}^2$

Laminar Flow	$\text{Re} < 500$
Turbulent Flow	$\text{Re} > 1000$

For practical open channel flows in civil engineering, usually $\text{Re} \gg 1000$, i.e., turbulent flow (try Re for $R=1\text{m}$ and $V=1\text{m}/\text{s}$).

8.3 Energy Loss Equations

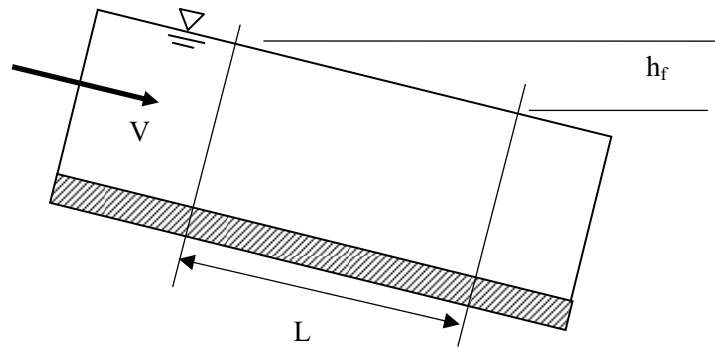

Similar to the pipe flow energy equation (replace pipe diameter D with hydraulic radius R), hence

$$h_f = \lambda \frac{L}{R} \frac{V^2}{2g}$$

Rearrange it into

$$V = \sqrt{\frac{2g}{\lambda} R \frac{h_f}{L}}$$

STUDY AT A TOP RANKED INTERNATIONAL BUSINESS SCHOOL

Reach your full potential at the Stockholm School of Economics, in one of the most innovative cities in the world. The School is ranked by the Financial Times as the number one business school in the Nordic and Baltic countries.

Visit us at www.hhs.se



So

$$V = C\sqrt{RS_0} \text{ where } S_0 = h_f / L, \text{ and } C = \sqrt{2g / \lambda}$$

This is the famous Chézy Equation and C = the Chézy coefficient. C is not constant and depends on the Reynolds Number and boundary roughness.

Another derivation with the coefficient by setting $C = R^{1/6} / n$ results in the Manning Equation. Manning’s Equation is the most widely used formula in engineering and all the examples and questions in this book are based on this formula.

Manning’s Equation

$$V = \frac{R^{2/3} \sqrt{S_0}}{n}$$

where $n =$ Manning’s coefficient

Since $Q=AV$, another form of the Manning Equation is

$$Q = \frac{A^{5/3} \sqrt{S_0}}{nP^{2/3}}$$

Manning’s n can be estimated by measuring Q, A, P, and S_0 for a chosen channel reach & cross section. In practice, many researchers have carried out a large number of experiments to estimate Manning’s n and they can be found in most hydraulics handbooks.

Typical values of Manning’s n

Channel type	Surface	n		
River	earth	0.02	-	0.025
	gravel	0.03	-	0.04
Unlined canals	earth	0.018	-	0.025
	rock	0.025	-	0.045
Lined canals	concrete	0.012	-	0.017

Note: More values can be found in Chow’s Open Channel Hydraulics (1959).

8.4 Computation of Uniform Flow

There are two common problems to solve:

1) Determine the *discharge* given the depth

Example:

The normal depth of flow in a trapezoidal concrete lined channel is 2 m. The channel has a base width of 5 m and side slope of 1 (vertical):2 (Horizontal). Manning's n is 0.015 and the bed slope S_0 is 0.001. Determine the discharge Q and the mean velocity V .

Solution:

Known: $b = 5$ m, $y = 2$ m, $x = 2$, $n = 0.015$, $S_0 = 0.001$

Unknown: Q, V

$$A = (b + xy)y = (5 + 2 \times 2) \times 2 = 18 \text{ m}^2$$

$$P = b + 2y\sqrt{1 + x^2} = 5 + 2 \times 2\sqrt{5} = 13.94 \text{ m}$$

$$R = A/P = 1.29 \text{ m}$$

Compute V first, then Q

$$V = \frac{R^{2/3} \sqrt{S_0}}{n} = \frac{1.29^{2/3} \sqrt{0.001}}{0.015} = 2.5 \text{ m/s}$$

$$Q = AV = 18 \times 2.5 = 45 \text{ m}^3/\text{s}$$

2) Determine the *depth* given the discharge

Example:

If the discharge in the channel given in the last example is $30 \text{ m}^3/\text{s}$, find the normal depth of the flow.

Solution:

Known: $b = 5$ m, $Q = 30 \text{ m}^3/\text{s}$, $x = 2$, $n = 0.015$ and $S_0 = 0.001$

Unknown: y

$$A = (b + xy)y = (5 + 2y)y$$

$$P = b + 2y\sqrt{1 + x^2} = 5 + 2\sqrt{5}y$$

$$\text{So } Q = \frac{A^{5/3} \sqrt{S_0}}{nP^{2/3}} = \frac{[(5 + 2y)y]^{5/3} \times \sqrt{0.001}}{0.015 \times [5 + 2\sqrt{5}y]^{2/3}}$$

or
$$14.23 = \frac{[(5 + 2y)y]^{5/3}}{(5 + 2\sqrt{5}y)^{2/3}}$$

Trial-and-error method (try to find a y value which makes the Right-Hand-Side close to 14.23)

y	RHS
1	5.72
1.5	12.20
1.6	13.80
1.7	15.52
1.65	14.65

Hence the answer is $y = 1.65$ m

Note:

Slope description options (different descriptions for the same slope):

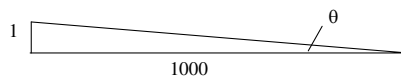

 [Click on the ad to read more](#)

Channel bed slope $S_o = \tan \theta$

- a) 0.001; b) 0.1 percent; c) 1:1000; d) 1 (V):1000 (H); e) 1m drop over 1km length

Channel side slope

- a) 1:2 (as the channel bed slope); b) 1 (V): 2(H) ; c) $x=2$ (X is the inverse of slope)

Questions 8
Uniform Flow

1. Water is in steady uniform flow through a finished-concrete channel (Manning's $n=0.012$) as shown below. If the bed slope is $S_o = 0.0016$, what is the discharge?

(Answer: $102 \text{ m}^3/\text{s}$)

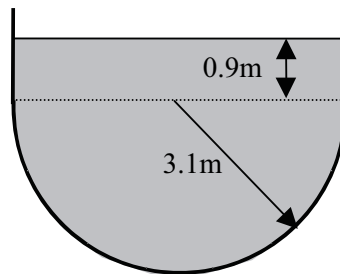

2. A trapezoidal channel has Manning's $n=0.020$ and bed slope $S_o=0.0004$, which is made in the shape of a half-hexagon for maximum efficiency. For what length of L will the channel carry $7.1 \text{ m}^3/\text{s}$ of water at its full capacity?

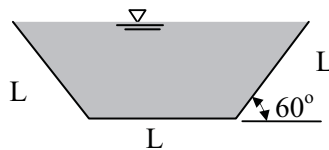

(Answer: 2.33 m)

3. A trapezoidal channel with a bottom width of 6m, a side slope of 1 (vertical):2 (horizontal), $n=0.02$, and a bed slope $S_o=0.0014$, conveys a flow of $30 \text{ m}^3/\text{s}$. Estimate the normal depth of flow in this situation.

(Answer: 1.60 m)

4. Given a circular culvert of 0.95 m in diameter with $S_o=0.0016$ and Manning's $n=0.015$, find the normal depth of flow for a discharge of $0.41 \text{ m}^3/\text{s}$.

(Answer: 0.511 m)

Solutions 8
Uniform Flow

1. Area

$$A = \frac{\pi \cdot 3.1^2}{2} + 0.9 \times 2 \times 3.1 = 20.7 \text{ m}^2$$

Hydraulic radius

$$R = \frac{A}{P} = \frac{20.7}{3.1\pi + 2 \times 0.9} = 1.8 \text{ m}$$

From the Manning Equation

$$Q = AV = A \frac{R^{2/3} \sqrt{S_o}}{n} = 20.7 \frac{1.8^{2/3} \sqrt{0.0016}}{0.012} = 102 \text{ m}^3 / \text{s}$$

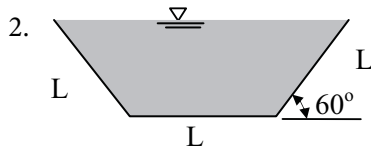

$$A = L \sin 60^\circ (L + L \cos 60^\circ) = L^2 \frac{\sqrt{3}}{2} \frac{3}{2} = 1.299 L^2$$

$$P = 3L$$

$$R = A / P = 1.299 / 3L = 0.433L$$

$$Q = AV = A \frac{R^{2/3} \sqrt{S_o}}{n} = 1.299 L^2 \frac{(0.433L)^{0.667} \sqrt{0.0004}}{0.02} = 7.1$$

$$L^{2.667} = 9.55$$

$$L = 2.33 \text{ m}$$

3. From the Manning Equation

$$A = (b + xy)y = (6 + 2y)y$$

$$P = b + 2y\sqrt{1 + x^2} = 6 + 2y\sqrt{1 + 2^2} = 6 + 4.47y$$

$$R = \frac{(6 + 2y)y}{6 + 4.47y}$$

$$Q = \frac{A^{5/3} \sqrt{S_o}}{nP^{2/3}} = \frac{[(6 + 2y)y]^{5/3} \sqrt{0.0014}}{0.02 \times (6 + 4.47y)^{2/3}} = 30 \text{ m}^3 / \text{s}$$

Simplifying

$$\frac{[(6 + 2y)y]^{5/3}}{(6 + 4.47y)^{2/3}} = 16.03$$

Try	Left
y=1	6.69
y=1.5	14.05
y=1.6	15.87

So the normal depth is about 1.60 m

“I studied English for 16 years but...
...I finally learned to speak it in just six lessons”
Jane, Chinese architect

ENGLISH OUT THERE

Click to hear me talking before and after my unique course download



4. Known: $D = 0.95 \text{ m}$, $Q = 0.41 \text{ m}^3/\text{s}$
 $n = 0.015$, $S_0 = 0.0016$

Unknown: y

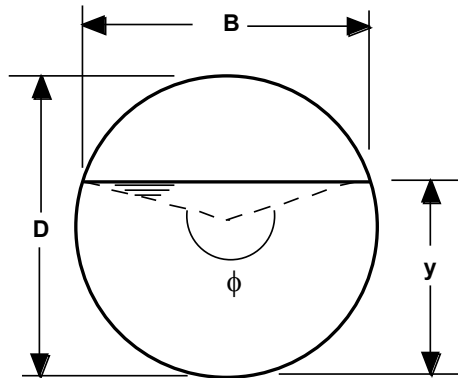

Using the following equations

Angle $\phi = 2 \cos^{-1} \left(1 - \frac{2y}{D} \right)$

Area $A = \frac{1}{8} (\phi - \sin \phi) D^2$

Wetted perimeter $P = \frac{1}{2} \phi D$

With Manning's equation

$$Q = \frac{A^{5/3} \sqrt{S_0}}{nP^{2/3}}$$

So

$$0.41 = \frac{[(\phi - \sin \phi) 0.95^2 / 8]^{5/3} \sqrt{0.0016}}{0.015 (0.95 \phi / 2)^{2/3}}$$

With n and S_0 substituted

$$3.56 = \frac{(\phi - \sin \phi)^{5/3}}{\phi^{2/3}}$$

Try and error

Method 1: Try different angles (note: from range 0- 2π)

ϕ	1	2	3	3.5	3.3
RHS	0.046	0.73	2.77	4.1	3.57

So $\phi = 3.3$,

$$\text{From } Q = \frac{A^{5/3} \sqrt{S_o}}{nP^{2/3}}$$

$$y = D[1 - \cos(\phi/2)]/2 = 0.95[1 - \cos(3.3/2)]/2 = 0.51m$$

Method 2: Try different depths (slightly more calculations)

Guess a y and then use to get the angle

Y	0.1	0.5	0.55	0.51
f	1.32	3.25	3.46	3.28
RHS	0.15	3.42	3.99	3.54

So $y = 0.51$

Method 3: Matlab

$$\text{With } 3.56 = \frac{(\phi - \sin \phi)^{5/3}}{\phi^{2/3}}$$

Write a function in f.m:

$$\begin{aligned} \text{function } y &= f(x) \\ y &= (x - \sin(x))^{5/3} / x^{2/3} - 3.65; \end{aligned}$$

then

$$\begin{aligned} >> z = \text{fzero}(@f, 2) \\ \phi &= 3.3308 \end{aligned}$$

So

$$y = D[1 - \cos(\phi/2)]/2 = 0.95[1 - \cos(3.3308/2)]/2 = 0.5199m \approx 0.52m$$

9 Channel Design

9.1 Channel Design

Main purpose: to transport water between two points in a safe, cost-effective manner.

Channel Types: *Unlined, Lined(with concrete), Grassed*

Permissible Velocities

The maximum permissible velocity is the maximum velocity that will not cause erosion to the channel bed and walls.

The minimum permissible velocity is the lowest velocity that will prevent both sedimentation and vegetative growth. In general, 0.6 to 0.9 m/s is used.

Freeboard is the vertical distance from the top of a channel to the water surface at the design condition.

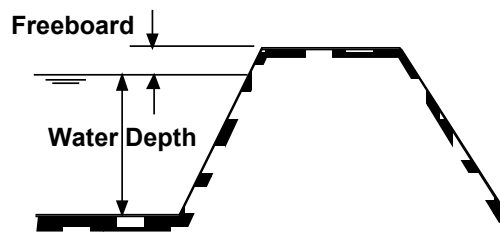

In design, 5% to 30% of the depth of flow is commonly used for freeboards.

9.2 Compound Channel

It is common to use compound channels in practical engineering projects to cope with different flows so that the sediments and vegetation in the channel could be controlled. However, the hydraulic computation for compound channels needs a special treatment as demonstrated by the following example.

Example 1:

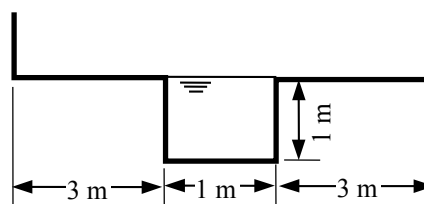

Case a: $S_o=0.001$, $n=0.02$, estimate the discharge in the channel

Solution:

The flow is contained in the main channel.

$$A = by = 1 \text{ m}^2, P = b+2y = 3 \text{ m}, R = A/P = 1/3 = 0.333 \text{ m}$$

$$V = \frac{R^{2/3} \sqrt{S_0}}{n} = \frac{0.333^{2/3} \sqrt{0.001}}{0.02} = 0.76 \text{ m/s}$$

$$Q = AV = 1 \times 0.76 = 0.76 \text{ m}^3 / \text{s}$$

Case b: The same channel with a slightly more discharge (0.01m extra water)

Solution:

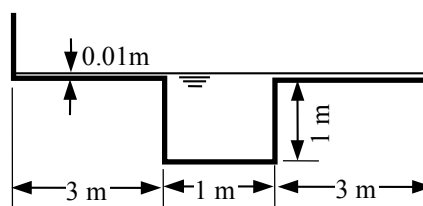

Excellent Economics and Business programmes at:



**university of
 groningen**



**“The perfect start
 of a successful,
 international career.”**

CLICK HERE
 to discover why both socially
 and academically the University
 of Groningen is one of the best
 places for a student to be

www.rug.nl/feb/education



The whole compound channel is treated as a whole cross section.

$$A = 1 \times 1 + 7 \times 0.01 = 1.07 \text{ m}^2$$

$$P = 3 + 3 + 3 + 0.01 + 0.01 = 9.02 \text{ m}$$

$$R = A/P = 1.07/9.02 = 0.1186 \text{ m}$$

$$V = \frac{R^{2/3} \sqrt{S_0}}{n} = \frac{0.1186^{2/3} \sqrt{0.001}}{0.02} = 0.38 \text{ m/s}$$

$$Q = AV = 1.07 \times 0.38 = 0.41 \text{ m}^3/\text{s}$$

The illogical result is due to the very different flow patterns between the main channel and the over bank flow. To solve this problem, it is necessary to treat different parts of the channel separately.

Divided the channel into three parts:

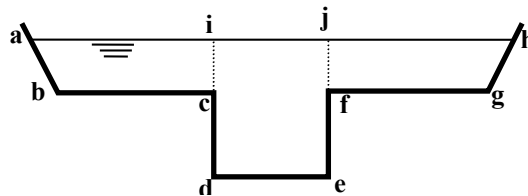

The main channel and two over-bank sections

Areas: A_1, A_2, A_3
 Wetted perimeter: $P_1(abc), P_2(cdef), P_3(fgh)$
 Calculate V and Q separately and combine them together.

Example 2

During a large flood, the water level in the channel is given in the following figure. Manning's n is 0.015 for the main channel and 0.035 for the flood banks. The bed slope S_0 is 0.001. Estimate the discharge for a maximum flood depth of 4 m.

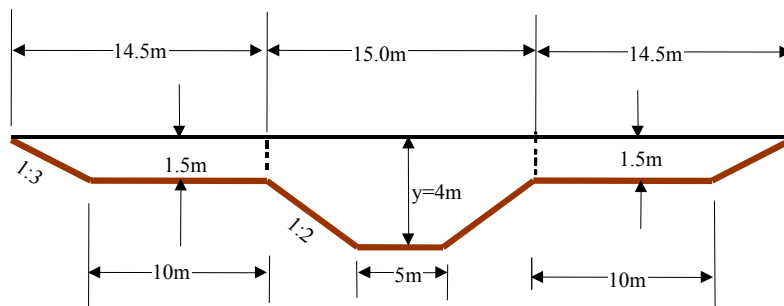

Solution:

Split the section into subsections (1) in the middle, (2) and (3) as overbank parts and apply Manning's equation to each one in turn and then sum the discharges.

For Subsection 1 in the middle

$$A_1 = 15 \times 1.5 + (5 + 15) \times 2.5 / 2 = 47.5 m^2$$

$$P_1 = 5 + (2\sqrt{5} \times 2.5) = 16.18 m$$

$$Q = \frac{A^{5/3} \sqrt{S_0}}{nP^{2/3}} = \frac{47.5^{5/3} \sqrt{0.001}}{0.015 \times 16.18^{2/3}} = 205.3 m^3 / s$$

Subsection 2 and Subsection 3 have the same dimensions, hence

$$A_2 = A_3 = \left(\frac{10 + 14.5}{2}\right) \times 1.5 = 18.38 m^2$$

$$P_2 = P_3 = 10 + (\sqrt{10} \times 1.5) = 14.74 m$$

$$Q_2 = Q_3 = \frac{A^{5/3} \sqrt{S_0}}{nP^{2/3}} = \frac{18.38^{5/3} \sqrt{0.001}}{0.035 \times 14.74^{2/3}} = 19.2 m^3 / s$$

Hence

$$Q = Q_1 + Q_2 + Q_3 = 243.7 m^3/s$$

9.3 The Best Hydraulic Section

A channel can have many shapes and dimensions. However, certain types of channels are better at conveying flows than others.

Example: The following channels have the same amount of excavation (cross section area), as well as the same Manning's n and bed slope. Which channel is the best hydraulically?

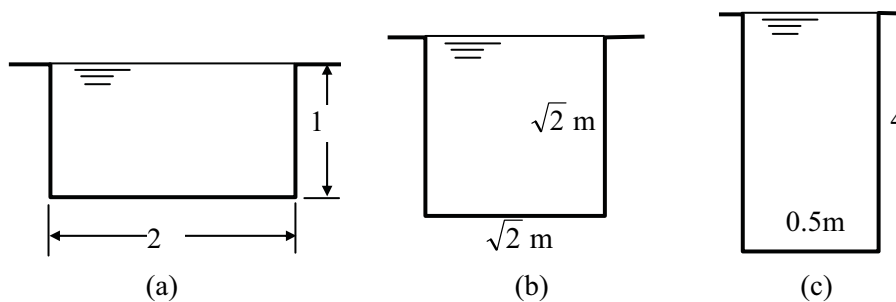

Solution:

Since $P = 4, 4.24, 8.5$

From $Q = \frac{A^{5/3} \sqrt{S}}{nP^{2/3}} = \frac{K}{P^{2/3}}$ (let $K = \frac{A^{5/3} \sqrt{S}}{n}$)

Then

$$Q_a = 0.397K, Q_b = 0.382K, Q_c = 0.240K$$

Hence a is the best and c is the worst.

A general pattern can be concluded from this example.

From Manning's Equation $Q = \frac{A^{5/3} \sqrt{S_0}}{nP^{2/3}}$

The channel having the least wetted perimeter for a given area has the maximum conveyance; such a section is known as the best hydraulic section.

The derivation of the best hydraulic sections for some common shapes is illustrated here.



In the past four years we have drilled

89,000 km

That's more than **twice** around the world.

Who are we?
We are the world's largest oilfield services company¹. Working globally—often in remote and challenging locations—we invent, design, engineer, and apply technology to help our customers find and produce oil and gas safely.

Who are we looking for?
Every year, we need thousands of graduates to begin dynamic careers in the following domains:

- Engineering, Research and Operations
- Geoscience and Petrotechnical
- Commercial and Business

What will you be?

careers.slb.com

Schlumberger

¹Based on Fortune 500 ranking 2011. Copyright © 2015 Schlumberger. All rights reserved.



Rectangular

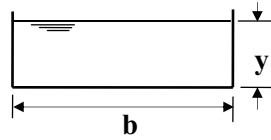

Let $A = by = \text{constant}$
 $b = A/y$

So $P = 2y + b = 2y + A/y$

Minimising P

$$\frac{dP}{dy} = 2 - \frac{A}{y^2} = 0$$

Then $\frac{A}{y^2} = 2$ or $\frac{by}{y^2} = 2$ so $b = 2y$

The best rectangular channel is the one with its depth being half of its width.

Trapezoidal

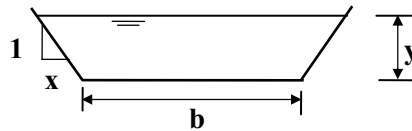

$$A = (b + xy)y$$

$$P = b + 2y\sqrt{1 + x^2}$$

Now $b = \frac{A}{y} - xy$

Hence $P = \frac{A}{y} - xy + 2y\sqrt{1 + x^2}$

$$\frac{\partial P}{\partial y} = -\frac{A}{y^2} - x + 2\sqrt{1 + x^2} = 0$$

$$\frac{\partial P}{\partial x} = -y + y \frac{2x}{\sqrt{1 + x^2}} = 0$$

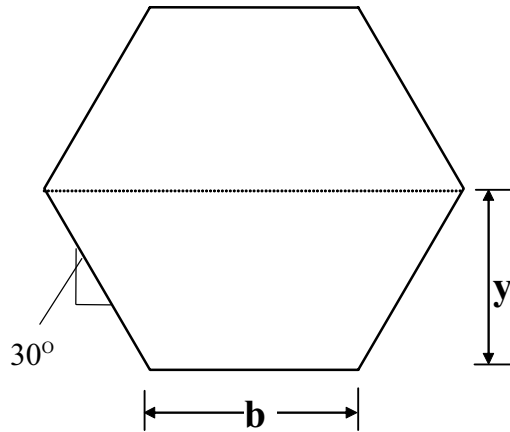

Solve both equations

$$x = \frac{\sqrt{3}}{3} = \tan 30^\circ$$

and

$$b = 2y(\sqrt{1+x^2} - x) = 2\left(\frac{\sqrt{3}y}{3}\right)$$

Its is one-half of a hexagon

Questions 9
Channel Design

1. Compute the discharge in a compound channel. The estimated Manning's n s are 0.015 for the main channel and 0.035 for the over-bank sections. The bed slope of the channel S_o is 0.001.

(Answer: 97.09 m³/s)

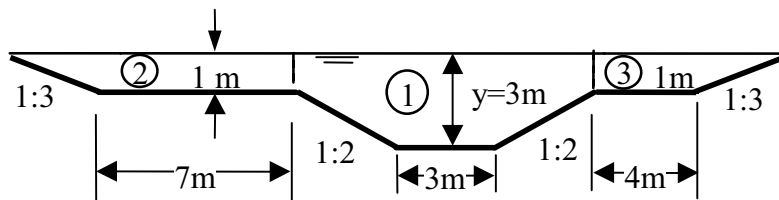

2. A rectangular, concrete lined channel (Manning's $n = 0.015$) is to be constructed to carry flood water. The slope of the channel bed slope is 1 in 500. The design discharge is $10\text{m}^3/\text{s}$.
 (a) Calculate the proportions of the rectangular channel that will minimize excavation and result in the optimum hydraulic section. (b) If the cross sectional area of flow is kept the same as in part (a) but for safety reasons the depth of flow in the channel is limited to 1.00m, what will be the discharge now?

(Answer: a) $B=2y=2.89\text{ m}$ b) $9.55\text{m}^3/\text{s}$)

3. Compare semicircular section with rectangular and trapezoidal sections to show that it is the most hydraulically efficient.
4. Show that the best hydraulic isosceles triangular section is one-half of a square.

Solutions 9
 Channel Design

1. Split the section into subsections (1), (2) and (3) and apply Manning's equation to each one in turn and then sum the discharges.

For Subsection 1: $B=3+2xy=3+2\times 2\times 2=11\text{m}$, $A_1=11\times 1+(3+11)\times 2/2 = 25\text{ m}^2$

$$P_1 = 3 + (2y\sqrt{1+x^2}) = 3 + 2 \times 2\sqrt{1+4} = 11.94\text{m}$$

$$Q_1 = \frac{A^{5/3}\sqrt{S_0}}{nP^{2/3}} = \frac{25^{5/3}\sqrt{0.001}}{0.015 \times 11.94^{2/3}} = \frac{6.74}{0.0782} = 86.1\text{m}^3/\text{s}$$

Subsection 2

$$A_2 = \left(\frac{10+7}{2}\right) \times 1.0 = 8.5\text{m}^2, P_2 = 7 + \sqrt{10} = 10.16\text{m}$$

$$Q_2 = \frac{A^{5/3}\sqrt{S_0}}{nP^{2/3}} = \frac{8.5^{5/3}\sqrt{0.001}}{0.035 \times 10.16^{2/3}} = \frac{1.12}{0.164} = 6.82\text{m}^3/\text{s}$$

Subsection 3

$$A_3 = \left(\frac{4+7}{2}\right) \times 1.0 = 5.5\text{m}^2, P_3 = 4 + \sqrt{10} = 7.16\text{m}$$

$$Q_3 = \frac{A^{5/3}\sqrt{S_0}}{nP^{2/3}} = \frac{5.5^{5/3}\sqrt{0.001}}{0.035 \times 7.16^{2/3}} = \frac{0.542}{0.130} = 4.17\text{m}^3/\text{s}$$

Hence $Q=Q_1+Q_2+Q_3=86.1+6.82+4.17= 97.09\text{ m}^3/\text{s}$

2. a) For the best rectangular section, $b=2y$, so $P = b + 2y = 2b$, $A = by = b^2 / 2$

$$Q = \frac{A^{5/3} \sqrt{S_0}}{nP^{2/3}} = \frac{(b^2 / 2)^{5/3} \sqrt{0.002}}{0.015(2b)^{2/3}} = 10$$

So

$$b^{8/3} = 16.91 \quad b = 2.89m$$

Channel width is 2.89m and depth is 1.45m

b) $A = by = 2.89 \times 1.44 = 4.16m^2$

If $y=1.0$, then

$$b = A / y = 4.16 / 1 = 4.16m, \quad P = b + 2y = 4.16 + 2 = 6.16m$$

$$Q = \frac{A^{5/3} \sqrt{S_0}}{nP^{2/3}} = \frac{4.16^{5/3} \sqrt{0.002}}{0.015 \times 6.16^{2/3}} = 9.55m^3 / s$$

American online LIGS University

is currently enrolling in the
Interactive Online **BBA, MBA, MSc,**
DBA and PhD programs:

- ▶ enroll **by September 30th, 2014** and
- ▶ **save up to 16%** on the tuition!
- ▶ pay in 10 installments / 2 years
- ▶ Interactive **Online** education
- ▶ visit www.ligsuniversity.com to
find out more!

Note: LIGS University is not accredited by any nationally recognized accrediting agency listed by the US Secretary of Education. More info [here](#).



Click on the ad to read more

3. For the same A, the best hydraulic sections for rectangle, trapezoid and semicircle are

1) Rectangle $A = \frac{b^2}{2}$ so $b = \sqrt{2A}$, $p = 2b = 2\sqrt{2A} = 2.83\sqrt{A}$

2) Trapezoid $A = (b + xy)y = \left(\frac{2}{\sqrt{3}y} + \frac{1}{\sqrt{3}}y\right)y = \sqrt{3}y^2$

So $y = \sqrt{\frac{A}{\sqrt{3}}} = 0.76\sqrt{A}$

$$P = b + 2y\sqrt{1+x^2} = b + \frac{4y}{\sqrt{3}} = \frac{2}{\sqrt{3}}y + \frac{4y}{\sqrt{3}} = 2\sqrt{3}y = 2.6\sqrt{A}$$

3) Semicircle $A = \frac{3.14r^2}{2}$, so $r = \sqrt{\frac{2}{3.14}A} = 0.798\sqrt{A}$

$$P = 3.14r = 3.14 \times 0.798\sqrt{A} = 2.51\sqrt{A}$$

So semicircle has the least perimeter among all sections with the same area; hence it is the most hydraulically efficient of all sections.

4. Method 1

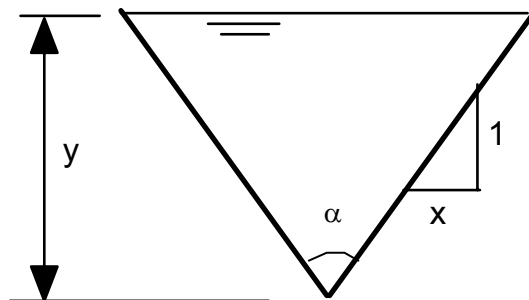

The area and wetted perimeter of a triangle are

$$A = xy^2, \text{ so } y = \sqrt{A/x}$$

$$P = 2y\sqrt{1+x^2} = 2\sqrt{A}\sqrt{x+1/x}$$

$$\frac{dP}{dx} = \sqrt{A} \left[\frac{1-1/x^2}{\sqrt{1/x+x}} \right] = 0$$

i.e., $1-1/x^2 = 0$

$$x = 1 = \tan 45^\circ$$

This means that the section is a half square.

Method 2

$$A = y^2 \tan(\alpha/2), \quad y = \sqrt{A/\tan(\alpha/2)}$$

$$P = 2y/\cos(\alpha/2) = 2\sqrt{A/\tan(\alpha/2)}/\cos(\alpha/2)$$

To minimize P is equivalent to minimize P^2 , i.e.,

$$\text{Min } z = 1/[\tan(\alpha/2)\cos^2(\alpha/2)] = \sin^{-1}(\alpha/2)\cos^{-1}(\alpha/2)$$

$$dz/d\alpha = [-\sin^{-2}(\alpha/2)\cos(\alpha/2)\cos^{-1}(\alpha/2)]/2 + \sin^{-1}(\alpha/2)\cos^{-2}(\alpha/2)\sin(\alpha/2)/2 = 0$$

$$-\sin^{-2}(\alpha/2) + \cos^{-2}(\alpha/2) = 0$$

$$\tan(\alpha/2) = 1 \text{ so } \alpha/2 = 45^\circ \text{ hence } \alpha = 90^\circ$$

This means that the section is a half square.

Method 3 Using Matlab to do the minimisation

$$\text{With } P = 2y/\cos(\alpha/2) = 2\sqrt{A/\tan(\alpha/2)}/\cos(\alpha/2)$$

$$\gg \text{fminunc}(\text{inline}('2*(1/\tan(x/2))^0.5/\cos(x/2)'), 1)$$

$$1.5709 \text{ (radian) i.e., } 1.5709*180/3.14159=90^\circ$$

Or with

$$P = 2y\sqrt{1+x^2} = 2\sqrt{A}\sqrt{x+1/x}$$

$$\gg \text{fminunc}(\text{inline}('2*(x+1/x)^0.5'), 1)$$

Answer =1, hence it is a half rectangular.

10 Critical Flow

Similar to airplanes with supersonic and subsonic speed classifications, water flow in open channels can also be classified into supercritical and subcritical flows. As a counterpart to the sound speed, the wave speed (also called celerity) is used in hydraulics.

10.1 Small Wave in Open Channel

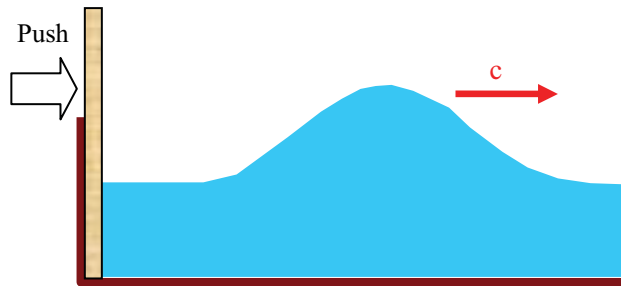

A small wave can be generated in an open channel by pushing a plate. The celerity of a small wave in open channel is

$$c = \sqrt{gD_m}$$

The derivation of this formula is explained in the unsteady flow chapter.

If a pebble is dropped into a channel with flowing water, the pattern generated could be one of the following cases that represent the four types of flow.

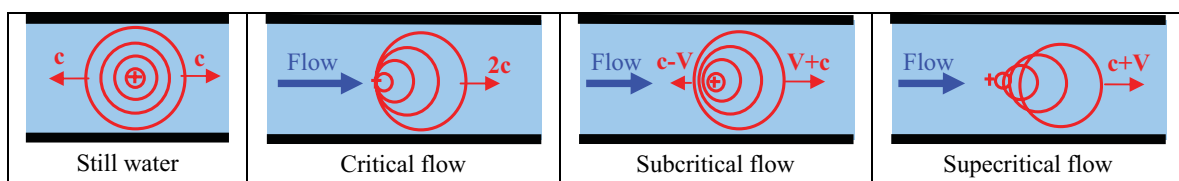

10.2 Critical Flow

Critical velocity

$$V_c = \sqrt{gD_m}$$

Froude Number

$$Fr = \frac{V}{\sqrt{gD_m}}$$

where

V the mean velocity
 D_m hydraulic mean depth, A/B

Flow state

Critical $Fr = 1$ or $Fr = 1$ or $V = \sqrt{gD_m}$
 Supercritical $Fr > 1$ or $Fr > 1$ or $V > \sqrt{gD_m}$
 Subcritical $Fr < 1$ or $Fr < 1$ or $V < \sqrt{gD_m}$

In relation to critical flow

y_c the critical depth
 $y > y_c$, subcritical $y < y_c$, supercritical

S_c the critical slope
 $S_o < S_c$, mild slope $S_o > S_c$, steep slope

V_c the critical velocity
 $V < V_c$, tranquil flow $V > V_c$, rapid flow

.....Alcatel-Lucent 

www.alcatel-lucent.com/careers



What if you could build your future and create the future?

One generation's transformation is the next's status quo. In the near future, people may soon think it's strange that devices ever had to be "plugged in." To obtain that status, there needs to be "The Shift".

 [Click on the ad to read more](#)

10.3 Critical Flow Computation

a) If the critical depth is known, V_c is solved by

$$V_c = \sqrt{gD_m} \quad \text{and} \quad Q = AV_c$$

b) If the discharge is known, y_c is solved by (trial and error)

$$Q = A\sqrt{gD_m}$$

c) To get the critical slope S_c , use the Manning Equation

$$V_c = \frac{R_c^{2/3} \sqrt{S_c}}{n}$$

Rearrange it into
$$S_c = \left(\frac{nV_c}{R_c^{2/3}} \right)^2$$

Example

For a trapezoidal channel with a base width $b=6.0$ m, side slope $x=2$ (i.e., 1 vertical: 2 horizontal) and Manning's $n=0.02$, calculate the critical depth, critical velocity and critical slope if its discharge $Q=17\text{m}^3/\text{s}$.

Solution

$$A = (b + xy_c)y_c = (6 + 2y_c)y_c$$

$$B = b + 2xy_c = 6 + 4y_c$$

$$D_m = \frac{A}{B} = \frac{(6 + 2y_c)y_c}{6 + 4y_c} = \frac{(3 + y_c)y_c}{3 + 2y_c}$$

The discharge is

$$Q = A_c V_c = A_c \sqrt{gD_m}$$

So
$$17 = (6 + 2y_c)y_c \sqrt{g \frac{(3 + y_c)y_c}{3 + 2y_c}}$$

Simplifying,

$$7.36 = \frac{[(3 + y_c)y_c]^3}{(3 + 2y_c)}$$

By trial and error, the critical depth is approximately

$$y_c = 0.84m$$

and the corresponding critical velocity is

$$A = 6.45m^2$$

$$V_c = \frac{17}{6.45} = 2.6m/s$$

The critical slope

$$P = b + 2y_c \sqrt{1 + x^2} = 9.76m$$

$$R = \frac{A}{P} = 0.66m$$

$$s_c = \left(\frac{V_c n}{R^{2/3}} \right)^2 = \left(\frac{0.052}{0.758} \right)^2 = 0.005$$

Questions 10

Critical Flow

1. A rectangular channel is 3.0 m wide, has a 0.01 slope, flow rate of 5.3 m³/s, and n=0.011. Find its normal depth y_n and critical depth y_c .

(Answer: 0.4m, 0.683m)

2. Water flows in a rectangular channel at a depth of 1.22m and discharge of Q=5.66m³/s. Determine the minimum channel width if the channel is to be subcritical.

(Answer: 1.34m)

3. A rectangular channel has a bottom width of 8 m and Manning's n=0.025
 - a) Determine the normal slope at a normal depth of 2m when the discharge is 12 m³/s;
 - b) Determine the critical slope and the critical depth when the discharge is 12m³/s;
 - c) Determine the critical slope at the critical depth of 1.5m and compute the corresponding discharge.

(Answer: a) 0.0002, b) 0.009, 0.61 m, c) 0.008, 46.1m³/s)

4. For a trapezoidal channel with a base width $b=3.0$ m, Manning's $n=0.025$ and side slope $x=2$ (i.e. 1 vertical: 2 horizontal), calculate the critical depth, critical velocity and critical slope if its discharge $Q=10\text{m}^3/\text{s}$.

(Answer: 0.86 m, 2.46 m/s, 0.0076)

Solutions 10
Critical Flow

1. From the Manning equation

$$A = by = 3y, P = b + 2y = 3 + 2y$$

Since $Q = \frac{A^{5/3} \sqrt{S_o}}{nP^{2/3}}$ so $5.3 = \frac{(3y)^{5/3} \sqrt{0.01}}{0.011(3+2y)^{2/3}}$

Simplifying

Trial and error

$y=1.0$	0.342	
$y=0.5$	0.125	
$y=0.3$	0.057	
$y=0.4$	0.089	
$y=0.45$	0.107	close to 0.4



**Join the best at
the Maastricht University
School of Business and
Economics!**

Top master's programmes

- 33rd place Financial Times worldwide ranking: MSc International Business
- 1st place: MSc International Business
- 1st place: MSc Financial Economics
- 2nd place: MSc Management of Learning
- 2nd place: MSc Economics
- 2nd place: MSc Econometrics and Operations Research
- 2nd place: MSc Global Supply Chain Management and Change

Sources: Keuzegids Master ranking 2013; Elsevier 'Beste Studies' ranking 2012; Financial Times Global Masters in Management ranking 2012

Maastricht University is the best specialist university in the Netherlands (Elsevier)

Visit us and find out why we are the best!
Master's Open Day: 22 February 2014

www.mastersopenday.nl



So $y_n = 0.4 \text{ m}$

From the Froude number = 1

$$Q = A\sqrt{gD_m} = By_c\sqrt{gy_c}$$

$$y_c^{3/2} = \frac{Q}{B\sqrt{g}}$$

So

$$y_c = \left(\frac{5.3^2}{3^2 g} \right)^{\frac{1}{3}} = 0.683 \text{ m}$$

2. For a critical flow

$$Fr = \frac{V}{\sqrt{gy}} = 1$$

$$\frac{5.66 / (1.22b)}{\sqrt{1.22 \times g}} = 1$$

$$b = 1.34 \text{ m}$$

Hence, the minimum channel width if the flow is to be subcritical is 1.34m.

3. a) For the given data

$$A = by = 8 \times 2 = 16 \text{ m}^2$$

$$P = b + 2y = 8 + 2 \times 2 = 12 \text{ m}$$

$$R = \frac{A}{P} = \frac{16}{12} = 1.33 \text{ m}$$

From the Manning equation

$$S_o = \left(\frac{nQ}{AR^{\frac{2}{3}}} \right)^2 = \left(\frac{0.025 \times 12}{16 \times 1.33^{\frac{2}{3}}} \right)^2 = 0.0002$$

Thus, $S_o = 0.0002$ will maintain a uniform flow of $12 \text{ m}^3/\text{s}$ in this channel at a depth of 2m.

b) The critical depth

$$A = by_c = 8y_c$$

$$D_m = \frac{A}{B} = \frac{by_c}{b} = y_c$$

Flow velocity is

$$V_c = \frac{Q}{A} = \frac{12}{8y_c} = \frac{1.5}{y_c}$$

and at the critical depth

$$V_c = \sqrt{gD_m}$$

So $\frac{1.5}{y_c} = \sqrt{gy_c}$

$$y_c = \sqrt[3]{\frac{1.5^2}{g}} = 0.61m$$

Then $A = by_c = 8 \times 0.61 = 4.88m^2$

$$P = b + 2y_c = 8 + 2 \times 0.61 = 9.22m$$

$$R = \frac{A}{P} = \frac{4.88}{9.22} = 0.53m$$

$$S_c = \left(\frac{Qn}{AR^{\frac{2}{3}}} \right)^2 = \left(\frac{12 \times 0.025}{4.88 \times 0.53^{\frac{2}{3}}} \right)^2 = 0.009$$

c) $A = by_c = 8 \times 1.5 = 12m^2$

$$P = b + 2y_c = 8 + 2 \times 1.5 = 11m$$

$$R = \frac{A}{P} = \frac{12}{11} = 1.09m$$

and at critical flow

$$V_c = \sqrt{gD_m} = \sqrt{gy_c} = \sqrt{1.5g} = 3.84m/s$$

The critical slope will be

$$S_c = \left(\frac{V_c n}{R^{\frac{2}{3}}} \right)^2 = \left(\frac{3.84 \times 0.025}{1.09^{\frac{2}{3}}} \right)^2 = 0.008$$

The flow rate is given by

$$Q = V_c A = 3.84 \times 12 = 46.1m^3/s$$

$$\begin{aligned}
 4. \quad A &= (b + xy_c)y_c = (3 + 2y_c)y_c \\
 B &= b + 2xy_c = 3 + 4y_c \\
 D_m &= \frac{A}{B} = \frac{(3 + 2y_c)y_c}{3 + 4y_c}
 \end{aligned}$$

The flow velocity is

$$V_c = \frac{Q}{A} = \frac{10}{(3 + 2y_c)y_c}$$

and at the critical depth

$$V_c = \sqrt{gD_m}$$

so

$$\frac{10}{(3 + 2y_c)y_c} = \sqrt{g \frac{(3 + 2y_c)y_c}{3 + 4y_c}}$$

Simplifying, $10.19 = \frac{[(3 + 2y_c)y_c]^3}{(3 + 4y_c)}$



> Apply now

REDEFINE YOUR FUTURE
**AXA GLOBAL GRADUATE
 PROGRAM 2015**

redefining / standards 

agence.cdg. © Photonistop

By trial and error, the critical depth is approximately

$y_c=1.0$		17.86	
$y_c=0.5$		1.6	
$y_c=0.75$	6.41		
$y_c=0.85$	9.96		
$y_c=0.86$	10.38		close to 10.19

So $y_c = 0.86m$

and the corresponding critical velocity is

$$A = (3 + 2 \times 0.86) \times 0.86 = 4.06m^2$$

$$V_c = \frac{10}{4.06} = 2.46m/s$$

The critical slope

$$P = b + 2y_c\sqrt{1+x^2} = 3 + 2 \times 0.86\sqrt{1+2^2} = 6.85m$$

$$R = \frac{A}{P} = \frac{4.06}{6.85} = 0.59m$$

$$S_c = \left(\frac{V_c n}{R^{2/3}} \right)^2 = \left(\frac{2.46 \times 0.025}{0.59^{2/3}} \right)^2 = 0.0076$$

11 Rapidly Varied Flow

For a rapidly varied flow, its water surface profile changes suddenly. This occurs when there is a sudden change in the geometry of the channel (to be described in this chapter) or in the regime of the flow (hydraulic jump, to be described in the next chapter).

11.1 Sudden Transitions

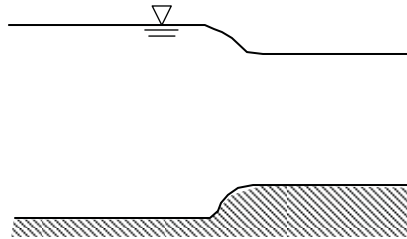

Transitions with a change of cross-sectional dimensions occurred in a relatively short distance

The energy equation is used to solve these problems.

The Energy Equation,

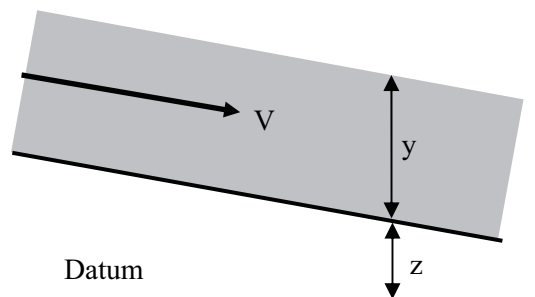

$$H = y + \frac{V^2}{2g} + z$$

Total energy head = pressure + kinetic+ potential

Conservation of energy

.....
 $H_1 - H_2 = H_{loss}$

.....
 (Usually H_{loss} is ignored in the computation of sudden transitional flow)

i.e. $H_1 = H_2$

11.2 Depth of Flow

A steady uniform flow in a rectangular channel of width 5m is interrupted by the presence of a hump of 0.2m in the channel. The upstream depth is 1.25 m and the discharge is 10 m³/s, find the depth of flow at position 2 (taking $\alpha=1$ and assume no energy loss).

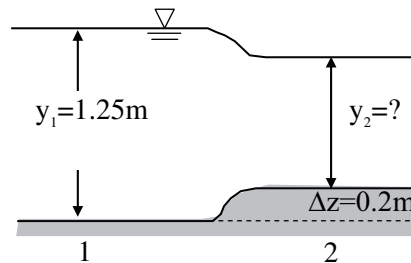

Solution:

Applying the energy equation,

$$y_1 + \frac{V_1^2}{2g} = y_2 + \frac{V_2^2}{2g} + \Delta z$$

Known: $y_1, V_1, \Delta z$

Unknown: y_2, V_2

Empowering People. Improving Business.

BI Norwegian Business School is one of Europe's largest business schools welcoming more than 20,000 students. Our programmes provide a stimulating and multi-cultural learning environment with an international outlook ultimately providing students with professional skills to meet the increasing needs of businesses.

BI offers four different two-year, full-time Master of Science (MSc) programmes that are taught entirely in English and have been designed to provide professional skills to meet the increasing need of businesses. The MSc programmes provide a stimulating and multi-cultural learning environment to give you the best platform to launch into your career.

- MSc in Business
- MSc in Financial Economics
- MSc in Strategic Marketing Management
- MSc in Leadership and Organisational Psychology

www.bi.edu/master



Since

$$V_1 = \frac{Q}{by_1} = \frac{10}{5 \times 1.25} = 1.6 \text{ m/s}$$

$$V_2 = \frac{Q}{by_2} = \frac{10}{5y_2} = \frac{2}{y_2}$$

So the energy equation would be

$$1.25 + \frac{1.6^2}{2g} = y_2 + \frac{2^2}{2gy_2^2} + 0.2$$

Simplify it into

$$y_2^3 - 1.18y_2^2 + 0.204 = 0$$

This is a cubic equation, in which y_2 is the only unknown (with three roots). Solve the equation and find y_2 .

$$y_2 = -0.36, 0.59, 0.96 \text{ m}$$

Only one root is the right answer. The negative one can be eliminated first.

The critical depth for the channel

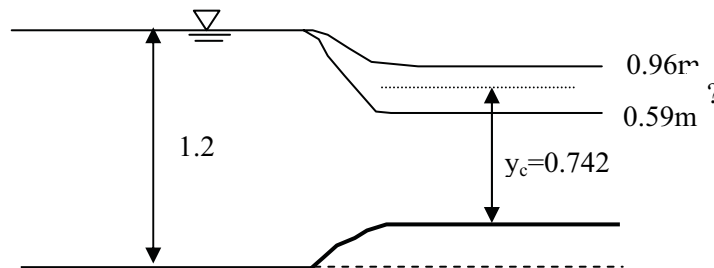

$$Q = AV_c = A\sqrt{gD_m} = by_c\sqrt{gy_c}$$

$$10 = 5y_c\sqrt{gy_c}$$

so

$$y_c = \left(\frac{4}{g}\right)^{1/3} = 0.742 \text{ m}$$

Since the critical depth is the limit for the flow over the hump, the root 0.59 m can be eliminated.

The right answer for y_2 is = 0.96m

11.3 Height of Hump

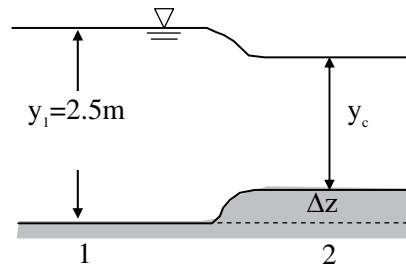

If the depth of flow in a 2m wide rectangular channel is 2.5 m when the discharge is 4 m³/s, estimate the height of the hump which would produce critical conditions.

Solution:

The energy equation

$$y_1 + \frac{V_1^2}{2g} = y_c + \frac{V_c^2}{2g} + \Delta z$$

$$V_1 = \frac{Q}{A_1} = \frac{4}{2 \times 2.5} = 0.8 \text{ m/s}$$

$$Q = AV_c = A\sqrt{gy_c} = by_c\sqrt{gy_c}$$

So

$$y_c = \left(\frac{4}{g}\right)^{1/3} = 0.742 \text{ m}$$

$$V_c = \frac{Q}{by_c} = \frac{4}{2 \times 0.742} = 2.70 \text{ m/s}$$

Substitute it into the energy equation

$$2.5 + \frac{0.8^2}{2g} = 0.742 + \frac{2.70^2}{2g} + \Delta z$$

$$2.53 = 1.11 + \Delta z$$

Then

$$\Delta z = 1.42 \text{ m}$$

11.4 Specific Energy

(Pressure + Kinetic energy)

$$E_s = y + \frac{V^2}{2g}$$

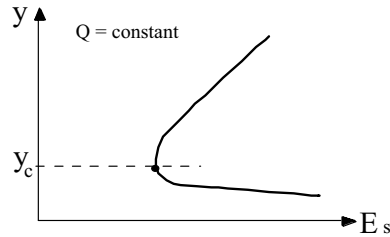

At critical depth, the specific energy is at the minimum point.

Mathematical derivation:

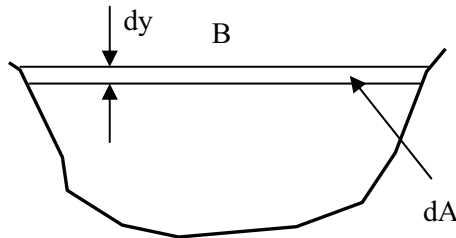

Need help with your dissertation?

Get in-depth feedback & advice from experts in your topic area. Find out what you can do to improve the quality of your dissertation!

Get Help Now



Go to www.helpmyassignment.co.uk for more info



Click on the ad to read more

From $\frac{dE_s}{dy} = 0$ and $E_s = y + \frac{V^2}{2g} = y + \frac{Q^2}{2gA^2}$

so

$$\frac{dE_s}{dy} = \frac{d}{dy} \left(y + \frac{Q^2}{2gA^2} \right) = 1 + \frac{Q^2}{2g} \frac{d}{dy} \left(\frac{1}{A^2} \right) = 1 - \frac{2Q^2}{2gA^3} \frac{dA}{dy}$$

From the figure on the right, $dA = Bdy$

$$\frac{Q^2 B}{gA^3} = 1 \text{ i.e. } \frac{V^2}{gD_m} = Fr^2 = 1$$

Hence, at the critical depth, the specific energy is the minimum.

Questions 11
Rapidly Varied Flow (Sudden Transitions)

- Water is flowing at a normal depth in a 3m wide rectangular channel with a bed slope of 1:500. If Manning’s $n=0.025$ and the discharge is $5\text{m}^3/\text{s}$. Calculate the height of a hump which would produce the critical flow without causing backwater upstream (i.e., raising the upstream water level).

(Answer: 0.31 m)

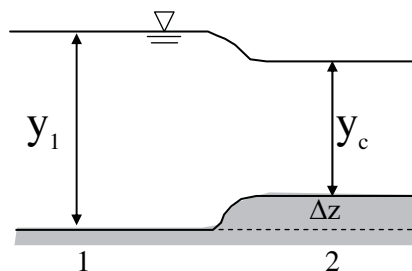

- Water is flowing at a velocity of 3.4 m/s and a depth of 3.4 m in a channel of rectangular section with a width of 3.4m. Find the changes in depth produced by

- 1) A smooth contraction to a width of 3.0m
- 2) The greatest allowable contraction for the flow to be possible upstream as described.

(Answer: 3.0m, 2.89m)

- The normal depth of flow in a rectangular channel (2m deep and 5m wide) is 1m. It is laid to a slope of 1m/km with a Manning’s $n=0.02$. Some distance downstream there is a hump of height 0.5m on the stream bed. Determine the depth of flow (y_1) immediately upstream of the hump and the depth of flow (y_2) above the hump. If the hump is reduced to 0.1m, what values will y_1 and y_2 be?

(Answer: 1.25m, 0.54m, 1.0m, 0.87m)

Solutions 11

Rapidly Varied Flow (Sudden Transitions)

1. From Manning equation

$$A = by = 3y, P = b + 2y = 3 + 2y$$

$$\text{Since } Q = \frac{A^{5/3} \sqrt{S_0}}{nP^{2/3}} \quad \text{so} \quad 5 = \frac{(3y)^{5/3} \sqrt{0.002}}{0.025(3 + 2y)^{2/3}}$$

Simplifying

$$2.795 = \frac{(3y)^{5/3}}{(3 + 2y)^{2/3}}$$

Trial and error

y=1.0	2.13	
y=1.2	2.74	close to 2.795

So $y = 1.20 \text{ m}$

$$V_1 = \frac{Q}{A_1} = \frac{5}{3 \times 1.2} = 1.39 \text{ m/s}$$

From Froude number=1

$$Q = A\sqrt{gD_m} = By_c\sqrt{gy_c}$$

$$y_c^{3/2} = Q / (B\sqrt{g})$$

so

$$y_c = [5^2 / (3^2 g)]^{1/3} = 0.66 \text{ m}$$

$$V_c = \frac{Q}{y_c B} = 2.53 \text{ m/s}$$

From the energy equation

$$y_1 + \frac{V_1^2}{2g} = \Delta z + y_c + \frac{V_c^2}{2g}$$

$$1.2 + \frac{1.39^2}{2 \times 9.8} = \Delta z + 0.66 + \frac{2.53^2}{2 \times 9.8}$$

$$\Delta z = 0.31 \text{ m}$$

2. 1) By the energy equation

$$y_1 + \frac{V_1^2}{2g} = y_2 + \frac{V_2^2}{2g}$$

$$3.4 + \frac{3.4^2}{2g} = y_2 + \frac{V_2^2}{2g}$$

Since $Q = V_1 y_1 b = 3.4 \times 3.4 \times 3.4 = 39.3 \text{ m}^3 / \text{s}$

$$V_2 = \frac{Q}{b_2 y_2} = \frac{39.3}{3y_2} = \frac{13.1}{y_2}$$

So

$$3.4 + \frac{3.4^2}{2g} = y_2 + \frac{13.1^2}{2gy_2^2}$$

Simply

$$3.99 = y_2 + \frac{8.75}{y_2^2}$$



Brain power

By 2020, wind could provide one-tenth of our planet's electricity needs. Already today, SKF's innovative know-how is crucial to running a large proportion of the world's wind turbines.

Up to 25 % of the generating costs relate to maintenance. These can be reduced dramatically thanks to our systems for on-line condition monitoring and automatic lubrication. We help make it more economical to create cleaner, cheaper energy out of thin air.

By sharing our experience, expertise, and creativity, industries can boost performance beyond expectations. Therefore we need the best employees who can meet this challenge!

The Power of Knowledge Engineering

Plug into The Power of Knowledge Engineering.
Visit us at www.skf.com/knowledge

SKF

Before trial and error, find the critical depth

$$\text{From } V_c = \sqrt{gy_c} = \frac{Q}{y_c b} \quad y_c = [Q^2 / (gb^2)]^{1/3} = [(39.3^2 / 3^2 g)]^{1/3} = 2.60m$$

by trial and error between (2.6 m to 3.4 m)

$$y_2=3.0 \text{ m, } 3.97$$

$$y_2=3.1 \text{ m, } 4.01$$

$$\text{So } y_2=3.0 \text{ m}$$

2) Critical depth at section 2

$$\begin{aligned} \text{Energy equation } \quad y_1 + \frac{V_1^2}{2g} &= y_2 + \frac{V_2^2}{2g} \\ 3.4 + \frac{3.4^2}{2g} &= y_2 + \frac{V_2^2}{2g} \end{aligned}$$

$$\text{Since } V_c = \sqrt{gy_c}, \quad y_2 = y_c,$$

$$3.4 + \frac{3.4^2}{2g} = y_c + \frac{gy_c}{2g}$$

$$3.99 = \frac{3}{2}y_c, \quad y_c = 2.66m$$

$$b_2 = \frac{Q}{V_c y_c} = \frac{39.3}{\sqrt{gy_c} y_c} = 2.89m$$

Maximum contraction to 2.89 m

3. a) Area

$$A = 5m^2$$

Hydraulic radius

$$R = \frac{A}{P} = \frac{5}{5+2} = 0.71m$$

$$Q = AV = A \frac{R^{2/3} \sqrt{S_o}}{n} = 5 \frac{0.71^{2/3} \sqrt{0.001}}{0.02} = 6.29m^3 / s$$

$$Q = A_c V_c = (by_c) \sqrt{gy_c} = b \sqrt{g} y_c^{3/2} = 6.29$$

$$y_c = \sqrt[3]{(6.29/b)^2 / g} = 0.54m,$$

$$V_c = \sqrt{gy_c} = \sqrt{0.54g} = 2.3m/s$$

b) Check the height of hump that can produce critical flow without causing backwater

The total energy at the hump

$$y_c + \frac{V_c^2}{2g} + z = 0.54 + \frac{2.3^2}{2g} + z = 0.81 + z$$

Before the hump

$$y_1 + \frac{V_1^2}{2g} = 1 + \frac{(6.29/5)^2}{2g} = 1.08m$$

So

$$0.81 + z = 1.08$$

$$z = 1.08 - 0.81 = 0.27m$$

c) Therefore, 0.5m hump will produce critical flow over the hump and cause backwater

The total energy at the hump

$$y_c + \frac{V_c^2}{2g} + z = 0.54 + \frac{2.3^2}{2g} + 0.5 = 1.31m$$

Before the hump

$$y_1 + \frac{V_1^2}{2g} = y_1 + \frac{(Q/by_1)^2}{2g} = 1.31m$$

$$y_1 + 0.081y_1^{-2} = 1.31m$$

Trial and error ($y_1 > 1.0m$ due to the hump):

$$y_1 = 1.1, \text{ LHS} = 1.17$$

$$y_1 = 1.2, \text{ LHS} = 1.26$$

$$y_1 = 1.3, \text{ LHS} = 1.35$$

$$y_1 = 1.25, \text{ LHS} = 1.30$$

$$\text{So } y_1 = 1.25 \text{ m}$$

d) If the hump is 0.1m, no backwater will be produced, therefore,

$$y_1 = 1m$$

The total energy at the hump

$$y_2 + \frac{V_2^2}{2g} + z = y_2 + 0.081y_2^{-2} + 0.1$$

Before the hump

$$y_1 + \frac{V_1^2}{2g} = 1 + \frac{(6.29/5)^2}{2g} = 1.08m$$

so

$$y_2 + 0.081y_2^{-2} + 0.1 = 1.08$$

i.e.

$$y_2^3 - 0.98y_2^2 + 0.081 = 0$$

Estimate y_2 (trial above 0.54m)

$$y_2 = 0.87m$$



What do you want to do?

No matter what you want out of your future career, an employer with a broad range of operations in a load of countries will always be the ticket. Working within the Volvo Group means more than 100,000 friends and colleagues in more than 185 countries all over the world. We offer graduates great career opportunities – check out the Career section at our web site www.volvogroup.com. We look forward to getting to know you!

VOLVO
AB Volvo (publ)
www.volvogroup.com

VOLVO TRUCKS | RENAULT TRUCKS | MACK TRUCKS | VOLVO BUSES | VOLVO CONSTRUCTION EQUIPMENT | VOLVO PENTA | VOLVO AERO | VOLVO IT
VOLVO FINANCIAL SERVICES | VOLVO 3P | VOLVO POWERTRAIN | VOLVO PARTS | VOLVO TECHNOLOGY | VOLVO LOGISTICS | BUSINESS AREA ASIA

12 Hydraulic Jump

A hydraulic jump occurs when a supercritical flow meets a subcritical flow. The resulting flow transition is rapid, and involves a large energy loss due to turbulence. The depth before the jump is called *the initial depth* and that after the jump is called *the sequent depth*.

It is used for dissipating energy in flow to protect dams, weirs, and other hydraulic structures.

12.1 Jump Equation

Because significant energy loss in hydraulic jumps, the energy equation is not a suitable tool in hydraulic jump analysis, therefore the momentum equation is applied.

The Momentum Equation

$$F = \rho Q(V_2 - V_1)$$

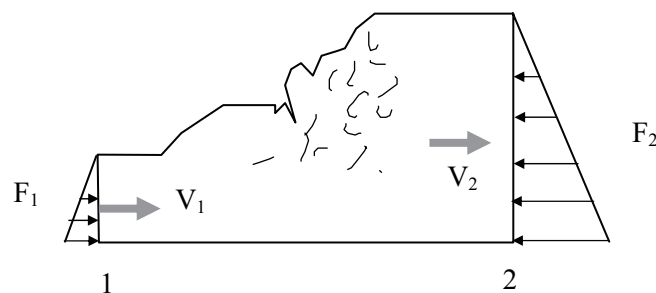

In flow direction

Net force = $F_1 - F_2$
(Ignore the channel frictional force)

Momentum change = $M_2 - M_1$

Hence

$$F_1 - F_2 = M_2 - M_1$$

so

$$F_1 + M_1 = F_2 + M_2$$

i.e.

$$F + M = \text{constant}$$

Hydrostatic pressure force

$$F = \rho g A \bar{y} \quad \text{and} \quad M = \rho Q V$$

where A = area \bar{y} = the depth of centroid

so

$$g(A_1 \bar{y}_1 - A_2 \bar{y}_2) = Q(V_2 - V_1)$$

The jump height can thus be evaluated knowing either upstream or downstream conditions

Energy dissipation

$$\Delta H = H_1 - H_2 = \left(y_1 + \frac{V_1^2}{2g}\right) - \left(y_2 + \frac{V_2^2}{2g}\right)$$

Hydraulic jump lengths can only be roughly estimated. One of the popular equations is $L=6.1 y_2$

gaiTeye
Challenge the way we run

EXPERIENCE THE POWER OF FULL ENGAGEMENT...

**RUN FASTER.
RUN LONGER..
RUN EASIER...**

**READ MORE & PRE-ORDER TODAY
WWW.GAITEYE.COM**

Example

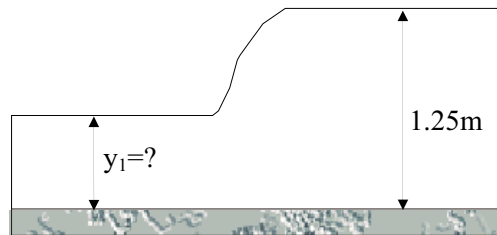

A hydraulic jump forms in a rectangular open channel with a width of 2 m in which water is flowing at 4. If the depth just downstream of the jump is 1.25 m. Calculate the theoretical depth upstream of the jump. Estimate the energy loss as a percentage of the initial energy.

Solution

From $F_1 - F_2 = M_2 - M_1$

$$F_1 = \rho g A_1 \bar{y}_1 = \rho g (2y_1) \frac{y_1}{2} = 9.81 \rho y_1^2$$

$$F_2 = \rho g A_2 \bar{y}_2 = \rho g (2 \times 1.25) \frac{1.25}{2} = 15.33 \rho$$

$$M_1 = \rho Q V_1 = \rho (4) \frac{Q}{A_1} = \rho \frac{4 \times 4}{2y_1} = \rho \frac{8}{y_1}$$

$$M_2 = \rho Q V_2 = \rho (4) \frac{Q}{A_2} = \rho \frac{4 \times 4}{2 \times 1.25} = 6.4 \rho$$

Substitute them into the momentum equation

$$9.81 \rho - 15.33 \rho = 6.4 \rho - \frac{8 \rho}{y_1}$$

Simplify it

$$y_1^3 - 2.22 y_1 + 0.82 = 0$$

Find y_1 (trial and error)

y_1	LHS
1	-0.4
0.5	-0.165
0.4	0.004

So $y_1 = 0.4\text{m}$

$$H_1 = y_1 + \frac{V_1^2}{2g} = 1.694\text{m}$$

$$H_2 = y_2 + \frac{V_2^2}{2g} = 1.380\text{m}$$

Energy loss = $1.694 - 1.380 = 0.314\text{ m}$

$$\% \text{loss} = \frac{0.314}{1.694} = 18.5\%$$

12.2 Hydraulic Jump in Rectangular Channel

If a jump occurs in a rectangular channel, there is no need to use trail and error approach and the unknown depth can be solved by the following equations.

$$y_2 = \sqrt{\frac{y_1^2}{4} + \frac{2q^2}{gy_1}} - \frac{y_1}{2} \qquad y_1 = \sqrt{\frac{y_2^2}{4} + \frac{2q^2}{gy_2}} - \frac{y_2}{2}$$

where $q = \frac{Q}{b}$

or in another form :

$$y_2 = \frac{y_1}{2} (\sqrt{1 + 8F_{r1}^2} - 1) \qquad y_1 = \frac{y_2}{2} (\sqrt{1 + 8F_{r2}^2} - 1)$$

For the last example: Input $y_2 = 1.25$ and $q=2$

$$y_1 = 0.396\text{m}$$

12.3 Hydraulic Jump in Trapezoidal Channel

A trapezoidal channel with a 6m bed width and side slope of 1:1.5 discharges water at a rate of 8.5 m³/s. If the normal depth downstream of a hydraulic jump is 1.2 m, what is the flow depth upstream of the jump?

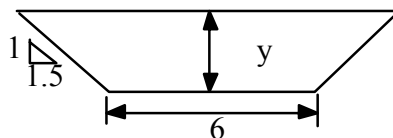

Solution:

Since $F_1 - F_2 = M_2 - M_1$

so $\rho g (A_1 \bar{y}_1 - A_2 \bar{y}_2) = \rho Q (V_2 - V_1)$

From $A = y(6 + 1.5y)$

so $A_1 = y_1(6 + 1.5y_1)$

$$A_2 = 1.2(6 + 1.5 \times 1.2) = 9.36 \text{ m}^2$$

$$A \bar{y} = \int_0^y [6 + 3(y - z)] z dz = [3z^2 + 1.5yz^2 - z^3]_0^y = 3y^2 + 0.5y^3$$

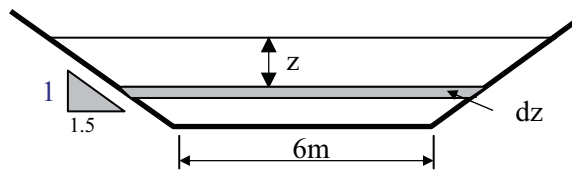

So

$$A_1 \bar{y}_1 = 3y^2 + 0.5y^3$$

$$A_2 \bar{y}_2 = 3 \times 1.2^2 + 0.5 \times 1.2^3 = 5.184 \text{ m}^3$$

This e-book
is made with
SetaPDF

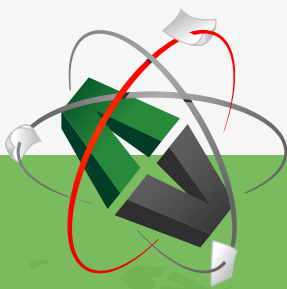

PDF components for PHP developers

www.setasign.com



Let $V=Q/A$

Thus,

$$9.81(3y_1^2 + 0.5y_1^3 - 5.184) = 8.5^2 \left(\frac{1}{9.36} - \frac{1}{y_1(6+1.5y_1)} \right)$$

Simplifying

$$5.97 - 3y_1^2 - 0.5y_1^3 = \frac{7.36}{y_1(6+1.5y_1)}$$

By trial and error

$$y_1 = 0.2 \text{ m}$$

12.4 Hydraulic jump in Sloping Channel

In flow direction: Net force = $F_g \sin\theta + F_1 - F_2$

Gravity force

$$F_g \approx \frac{1}{2} \rho g L (h_1 + h_2), \quad F_1 = \frac{1}{2} \rho g h_1^2 \cos \theta, \quad F_2 = \frac{1}{2} \rho g h_2^2 \cos \theta$$

where h_1 and h_2 are the perpendicular depths to the channel bed

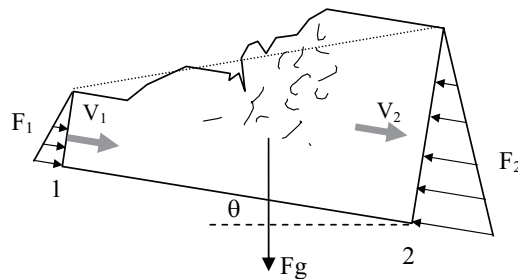

So
$$h_2 = \frac{h_1}{2} (\sqrt{1 + 8W_1^2} - 1)$$

where

$$W_1 = \frac{Fr_1}{\sqrt{\cos \theta - \frac{L \sin \theta}{h_2 - h_1}}}$$

then vertical depth $y_1 = h_1 / \cos\theta$ and $y_2 = h_2 / \cos\theta$

Questions 12
Hydraulic Jump

- Water is flowing at a rate of $10\text{m}^3/\text{s}$ through a rectangular channel 4 m wide, at a depth of 0.5 m. A weir downstream causes the water to backup the channel and a hydraulic jump occurs. Find the sequent depth and the loss of energy at the jump.

(Answer: 1.37m, 0.234 m)

- Water flows in a rectangular channel at a depth of 30cm and with a velocity of 16m/s. If a downstream sill forces a hydraulic jump, what will be the depth and velocity downstream of the jump? What head loss is produced by the jump?

(Answer: 3.81m, 1.26m/s, 9.46m)

- Starting from the first principles, show that the following equation holds true for a hydraulic jump in a trapezoidal channel:

$$\rho g \left(\frac{by^2}{2} + \frac{xy^3}{3} \right) + \frac{\rho Q^2}{(b + xy)y} = \text{constant}$$

where y is the depth of flow, b is the bottom width, Q is the discharge and x is the side slope (1 vertical to x horizontal). Draw the force momentum diagram for the following conditions and determine the initial depth if the sequent depth is 0.2m: $Q=50 \text{ l/s}$, $b=0.46\text{m}$, $x=1$.

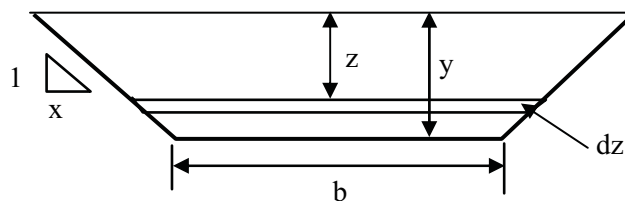

(Answer: the initial depth is 0.04m)

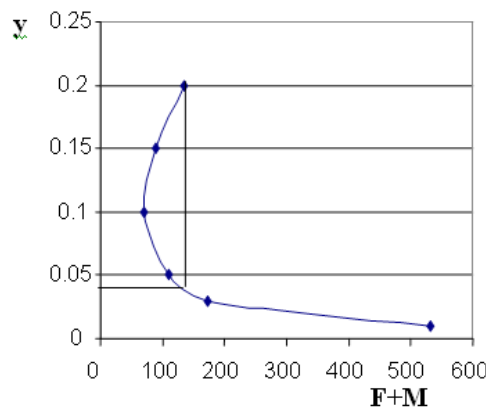

Solutions 12
Hydraulic Jump

1. From the rectangular channel equation

$$y_2 = \sqrt{\frac{y_1^2}{4} + \frac{2q^2}{gy_1}} - \frac{y_1}{2}$$

Input $y_1 = 0.5m$ and $q=2.5$

$$y_2 = \sqrt{\frac{y_1^2}{4} + \frac{2q^2}{gy_1}} - \frac{y_1}{2} = \sqrt{\frac{0.5^2}{4} + \frac{2 \times 2.5^2}{0.5g}} - \frac{0.5}{2} = 1.37m$$

$$H_1 = y_1 + \frac{V_1^2}{2g} = y_1 + \frac{q^2}{2gy_1^2} = 0.5 + \frac{2.5^2}{2 \times 9.81 \times 0.5^2} = 1.774m$$

$$H_2 = y_2 + \frac{V_2^2}{2g} = y_2 + \frac{q^2}{2gy_2^2} = 1.37 + \frac{2.5^2}{2 \times 9.81 \times 1.37^2} = 1.540m$$

Energy loss $\Delta H = H_1 - H_2 = 1.774 - 1.540 = 0.234 \text{ m}$



www.sylvania.com

**We do not reinvent
the wheel we reinvent
light.**

Fascinating lighting offers an infinite spectrum of possibilities: Innovative technologies and new markets provide both opportunities and challenges. An environment in which your expertise is in high demand. Enjoy the supportive working atmosphere within our global group and benefit from international career paths. Implement sustainable ideas in close cooperation with other specialists and contribute to influencing our future. Come and join us in reinventing light every day.

Light is OSRAM

**OSRAM
SYLVANIA** 

2. Since $F_1 = \frac{V_1}{\sqrt{gy_1}} = \frac{16}{\sqrt{0.3g}} = 9.33$

Use the rectangular hydraulic jump equation

$$y_2 = \frac{y_1}{2} \left(\sqrt{1 + 8Fr_1^2} - 1 \right) = \frac{0.3}{2} \left(\sqrt{1 + 8 \times 9.33^2} - 1 \right) = 3.81m$$

Since $V_1 y_1 b = V_2 y_2 b$

So $V_2 = \frac{V_1 y_1}{y_2} = \frac{16 \times 0.3}{3.81} = 1.26m/s$

$$E_{loss} = y_1 + \frac{V_1^2}{2g} - \left(y_2 + \frac{V_2^2}{2g} \right) = 0.3 + \frac{16^2}{2g} - \left(3.81 + \frac{1.26^2}{2g} \right) = 9.46m$$

3. $F + M = \text{constant}$

$$\rho g(A\bar{y}) + \rho QV = \text{constant}$$

$$A = y(b + xy)$$

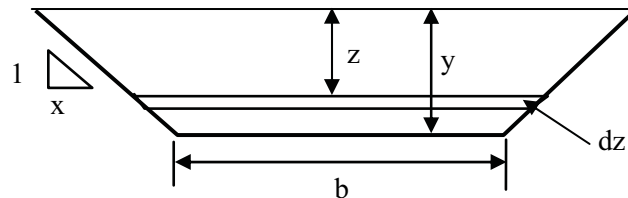

So

$$A\bar{y} = \int_0^y [b + 2x(y - z)]z dz = \left[bz^2 / 2 + xyz^2 - 2xz^3 / 3 \right]_0^y = by^2 / 2 + xy^3 / 3$$

$$\therefore \rho g(A\bar{y}) + \rho QV = \rho g(by^2 / 2 + xy^3 / 3) + \frac{\rho Q^2}{(b + xy)y} = \text{constant}$$

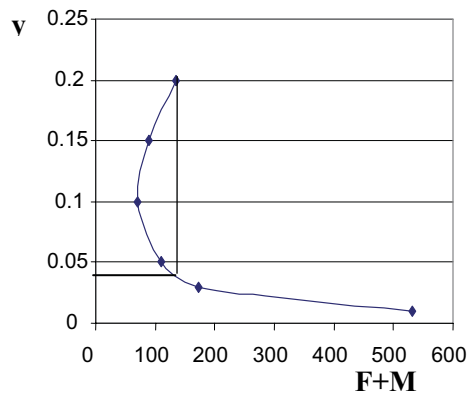

Force + momentum curve

$$F + M = 1000 \left[g \left(\frac{0.46y^2}{2} + \frac{y^3}{3} \right) + \frac{0.05^2}{(0.46 + y)y} \right]$$

$$= 1000 \left[g(0.23y^2 + 0.333y^3) + \frac{0.05^2}{(0.46 + y)y} \right]$$

$$y = 0.2 \quad F + M = 135 ; \quad y = 0.15 \quad F + M = 89 ;$$

$$y = 0.1 \quad F + M = 70.5 ; \quad y = 0.05 \quad F + M = 104 ;$$

$$y = 0.01 \quad F + M = 532 ; \quad y = 0.03 \quad F + M = 172$$

So the initial depth is about 0.04m.

13 Hydraulic Structures

Hydraulic structures are devices which are used to regulate or measure flow (weirs, flumes, spillways, gates, etc). The energy equation is applied to estimate the discharge and the momentum equation is used to calculate the forces on the structures.

13.1 Flumes (Venturi)

Flumes are used to measure discharge in channels. The energy equation is used to derive the flume formula.

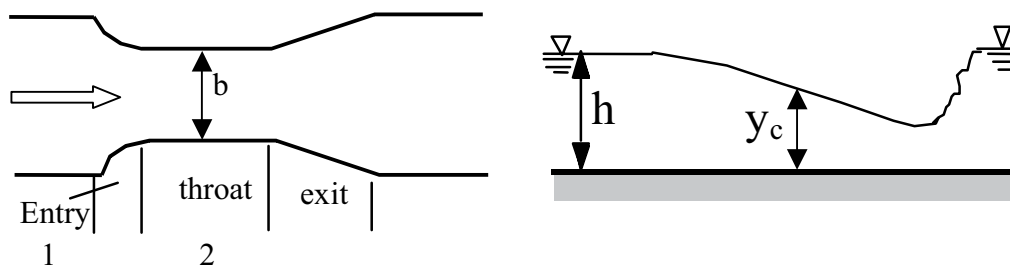

Discover the truth at www.deloitte.ca/careers

Deloitte.

© Deloitte & Touche LLP and affiliated entities.



If the width b is small enough, there will be a critical flow in the throat (*also it will cause backwater upstream to get extra energy and a hydraulic jump after the flume to get rid of the energy gained from the backwater*).

The energy equation between section 1 and 2 (ignore energy losses):

$$H_1 = H_2.$$

The total energy head at 2 is $H_2 = y_c + \frac{V_c^2}{2g} = y_c + \frac{(\sqrt{gy_c})^2}{2g} = 1.5y_c$

So
$$y_c = \frac{H_1}{1.5}$$

The discharge through the flume will be

$$Q_{ideal} = AV_c = by_c\sqrt{gy_c} = b\sqrt{g}y_c^{3/2} = b\sqrt{g}\left(\frac{H_1}{1.5}\right)^{1.5} = 1.705bH_1^{1.5}$$

In reality (to consider the energy losses)

$$Q = C_d Q_{ideal} = 1.705bC_d H_1^{1.5}$$

where C_d is the coefficient of discharge for the energy losses (see BS3680 4C)

If the depth h is used
$$Q = 1.705bC_d C_v h^{1.5}$$

where C_v is the coefficient of velocity for the upstream velocity head (also see BS3680 4C).

Such a structure is an example of *critical depth meter*.

Example Venturi Flume

An open channel is 2 m wide and of rectangular cross section. A venturi flume having a throat width of 1.0m is installed at one point. Estimate the discharge:

- if the upstream depth is 1.2 m and a critical flow occurs in the flume
- if the upstream depth is 1.2 m and the depth in the throat is 1.05 m
(Take $C_v=1$ and $C_d=0.95$)

Solution:

a) If the flow in the throat is critical

$$Q = 1.705C_d C_v b_2 h^{1.5} = 1.705 \times 0.95 \times 1.0 \times 1.2^{1.5} = 2.13 m^3 / s$$

b) If $h=1.2$ and $y_2=1.05$, use the energy equation (ignore the energy loss)

$$y_1 + \frac{V_1^2}{2g} = y_2 + \frac{V_2^2}{2g}$$

$$1.2 + \frac{Q^2}{2g(2 \times 1.2)^2} = 1.05 + \frac{Q^2}{2g(1 \times 1.05)^2}$$

$$\frac{Q^2}{2g}(0.907 - 0.174) = 0.15$$

$$\text{So } Q_{ideal} = 2.0 m^3 / s$$

Considering the coefficient of discharge with energy losses

$$Q = 0.95 \times 2.0 = 1.90 m^3 / s$$

13.2 Weirs (Broad-crested weir)

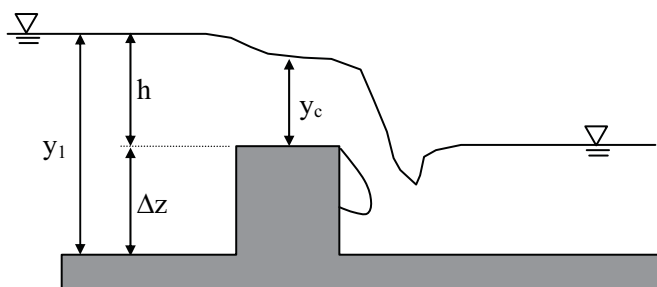

In a similar way to Venturi flume

$$Q = 1.705C_d C_v b h^{1.5}$$

where:

C_d – the coefficient of discharge

C_v – the coefficient of velocity

Broad crested weirs are robust structures and usually used in larger rivers in comparison with flumes. However, flumes usually create relatively smaller backwater (or afflux) than weirs and hence less energy loss. The floating debris can usually pass through them smoothly (a useful feature in sewerage treatment works).

13.3 Energy dissipators

Kinetic energy in flow can erode the foundation of dams and other hydraulic structures. It is important that excessive energy should be dissipated to protect the foundation.

1) Spillways

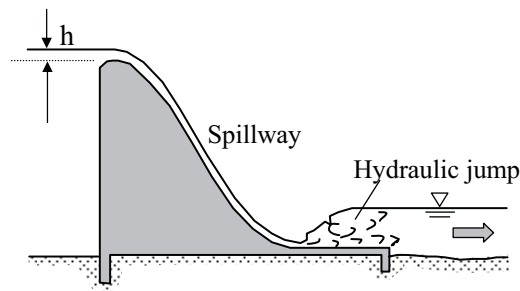

SIMPLY CLEVER

ŠKODA



We will turn your CV into an opportunity of a lifetime

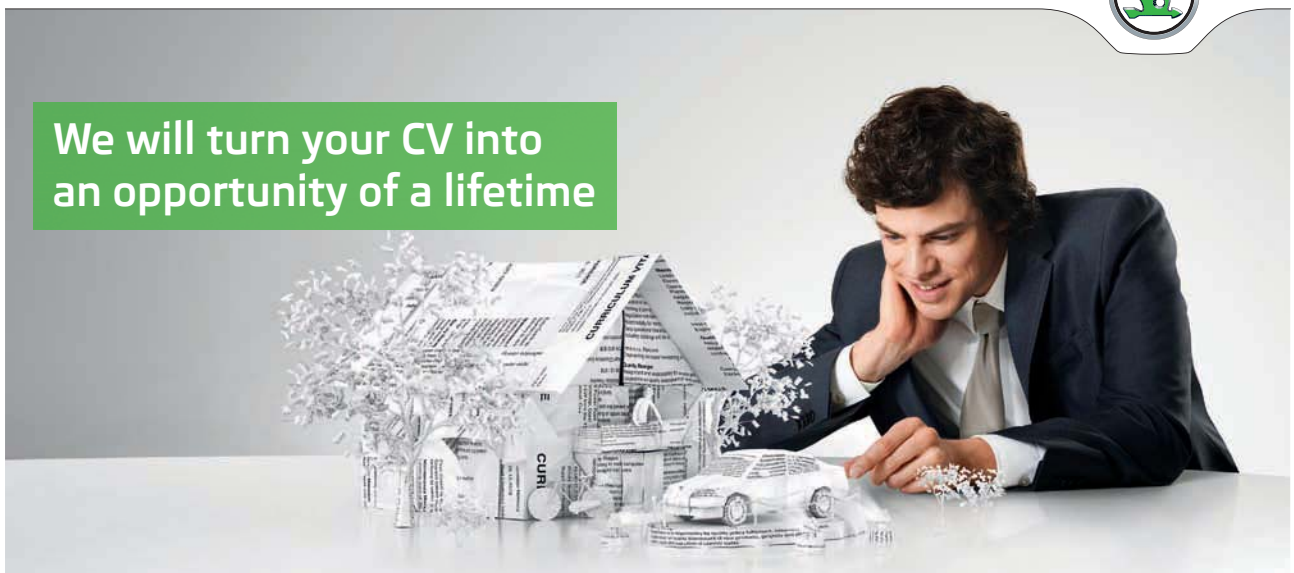

Do you like cars? Would you like to be a part of a successful brand? We will appreciate and reward both your enthusiasm and talent. Send us your CV. You will be surprised where it can take you.

Send us your CV on www.employerforlife.com



Click on the ad to read more

are safety structures for dams. They must have the capacity to discharge major floods without damage to the dams.

$$Q = Cbh^{1.5} \quad (C \text{ usually lies within } 1.6\text{--}2.3)$$

2) **Others** a) Stilling basin; b) Submerged bucket; c) Ski jump

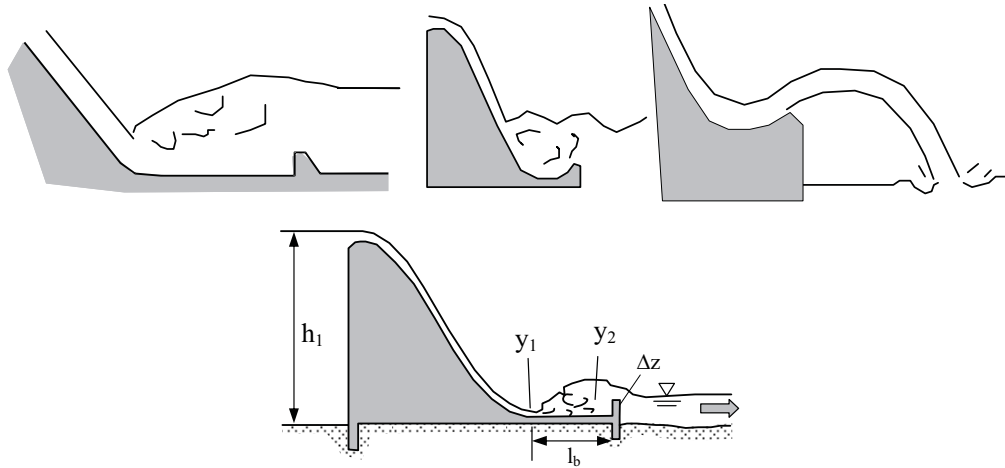

Stilling basin calculation

The velocity at Section 1

$$V_1 = \phi\sqrt{2gh_1}$$

ϕ is usually taken as 0.90–0.95

The depth before the jump (rectangular channel)

$$y_1 = \frac{Q}{bV_1}$$

The sequent depth

$$y_2 = \frac{y_1}{2}(\sqrt{1 + 8F_{r1}^2} - 1)$$

The wall at the end can be treated as a weir, so from $Q = 1.705bh^{1.5}$ (ignore the energy loss) to derive h.

The height of the wall will be $\Delta z = y_2 - h$

The length of the basin is shorter than free jumps ($6.1y_2$) due to the baffling effect from the end wall, so

$$l_b = (4.0 \sim 5.0)y_2$$

13.4 Sluice Gates

Energy Equation (Section 1 – 2)

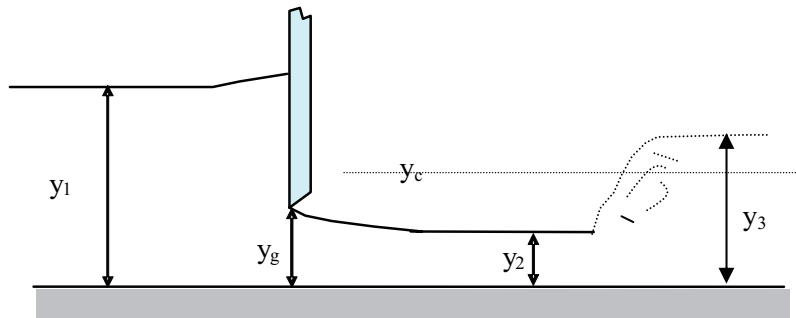

$$y_1 + \frac{V_1^2}{2g} = y_2 + \frac{V_2^2}{2g}$$

If y_1 and y_2 are known, discharge through the gate can be derived

$$Q = by_1y_2\sqrt{\frac{2g}{y_1 + y_2}}$$

In practice, it is easier to link the discharge with the gate opening, so

$$Q = C_dby_G\sqrt{2gy_1}$$

where

$$y_2 = C_cy_G \quad \text{and} \quad C_d = \frac{C_c}{\sqrt{1 + (C_cy_G/y_1)}}$$

C_c can be found from hydraulics manuals for various types of gates (usually between 0.61–0.66)

The force acting on the gate can be derived from the momentum equation between section 1 and 2 (ignore frictional forces). If the downstream depth is greater than the critical depth y_c , a hydraulic jump will occur in the channel. The sequent depth y_3 can be derived from the depth at y_2 . If the downstream depth is greater than y_3 , a submerged gate flow will occur and the flow equation derived here is not applicable anymore.

Questions 13
Hydraulic Structures

1. The depth-measurement scale of a Venturi flume with a 1.2m throat give an h reading that is 0.02m too large. Compute the percentage errors in discharge when the observed h readings are 0.2m and 0.6m (assume the critical flow condition for both cases).

(Answer: Around 17%, 5%)

2. Determine the width b_2 of the throat for a Venturi flume so that it will just produce critical flow, given $Q=40\text{m}^3/\text{s}$, $b_1=10\text{m}$ and $h_1=2\text{m}$. Also calculate the possible downstream supercritical flow depth h_3 (Neglect energy losses).

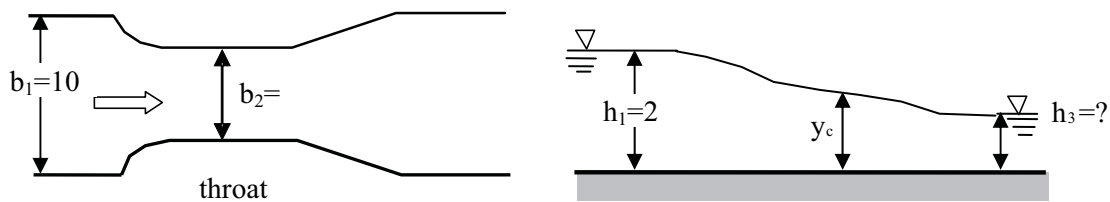

(Answer: 7.17m, 0.75m)

I joined MITAS because
I wanted **real responsibility**

The Graduate Programme
for Engineers and Geoscientists
www.discovermitas.com



Real work
International opportunities
Three work placements



Month 16
I was a construction supervisor in the North Sea advising and helping foremen solve problems





Solutions 13
Hydraulic Structures

1. Method a)

From

$$Q = 1.705C_d C_v b_2 h^{3/2}$$

and

$$\frac{dQ}{dh} = 1.705C_d C_v b_2 \frac{3}{2} h^{1/2} = 2.558C_d C_v b_2 h^{1/2}$$

then

$$\Delta Q \approx 1.705C_d C_v b_2 \frac{3}{2} h^{1/2} \Delta h = 2.558C_d C_v b_2 h^{1/2} \Delta h$$

The percentage error will be

$$\frac{\Delta Q}{Q_{true}} \approx \frac{2.558C_d C_v b_2 h^{1/2} \Delta h}{1.705C_d C_v b_2 h^{3/2}} = \frac{2.558 \times 0.02}{1.705h} = \frac{0.03}{h}$$

At $h=0.2$ m

$$\frac{\Delta Q}{Q_{true}} = \frac{0.03}{0.18} = 16.6\%$$

At $h=0.6$ m

$$\frac{\Delta Q}{Q_{true}} = \frac{0.03}{0.6 - 0.02} = 5.2\%$$

Method b)

From

If h is 0.02 too large, the percentage error will be

$$\frac{\Delta Q}{Q_{true}} = \frac{1.705C_d C_v b_2 (h)^{1.5} - 1.705C_d C_v b_2 (h - 0.02)^{1.5}}{1.705C_d C_v b_2 (h - 0.02)^{1.5}} = \frac{(h)^{1.5} - (h - 0.02)^{1.5}}{(h - 0.02)^{1.5}}$$

At $h=0.2$ m

$$\frac{\Delta Q}{Q} = \frac{0.2^{1.5} - 0.18^{1.5}}{0.18^{1.5}} = 17.1\%$$

At $h=0.6$ m

$$\frac{\Delta Q}{Q_{true}} = \frac{0.6^{1.5} - 0.58^{1.5}}{0.58^{1.5}} = 5.2\%$$

2. From the Venturi flume equation

$$Q = 1.705C_d C_v b_2 h^{3/2}$$

$$\text{Since } Q=40 \text{ m}^3/\text{s} \text{ and } H_1 = h_1 + \frac{V_1^2}{2g} = 2 + \frac{Q^2}{2g(b_1 h)^2} = 2 + \frac{40^2}{2g \times 10^2 \times 2^2} = 2.204m$$

$$\text{So } b_2 = \frac{Q}{1.705H_1^{3/2}} = \frac{40}{1.705 \times 2.205^{1.5}} = 7.170m$$

(You can also derive b_2 from the energy equation)

For the downstream depth h_3 ,

$$H_3 = h_3 + \frac{V_3^2}{2g} = h_3 + \frac{Q^2}{2g(b_1 h_3)^2} = h_3 + \frac{0.8157}{h_3^2}$$

$$\text{Since } H_1 = H_3 \text{ So } 2.204 = h_3 + \frac{0.8157}{h_3^2}$$

Trial and error (below 2m),

$$h_3 = 0.75m$$

14 Gradually Varied Flow

Gradually varied flow refers to the flow whose depth and velocity smoothly change over a long distance.

14.1 Equation of Gradually Varied Flow

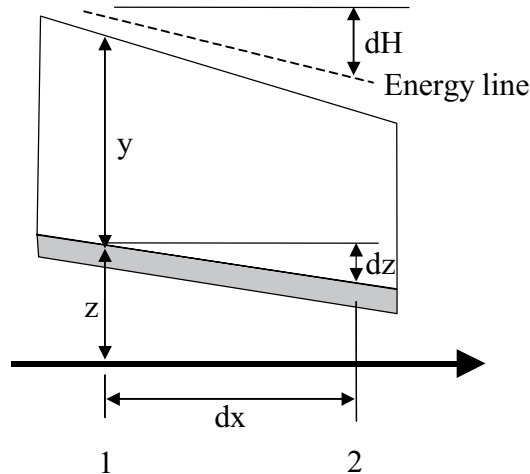

ie business school

#1 EUROPEAN BUSINESS SCHOOL
FINANCIAL TIMES 2013

#gobeyond

MASTER IN MANAGEMENT

Because achieving your dreams is your greatest challenge. IE Business School's Master in Management taught in English, Spanish or bilingually, trains young high performance professionals at the beginning of their career through an innovative and stimulating program that will help them reach their full potential.

- Choose your area of specialization.
- Customize your master through the different options offered.
- Global Immersion Weeks in locations such as London, Silicon Valley or Shanghai.

Because you change, we change with you.

www.ie.edu/master-management | mim.admissions@ie.edu | Facebook | Twitter | LinkedIn | YouTube | Instagram



The energy line slope S_f

$$S_f = -\frac{dH}{dx}$$

(The '-' sign is to compensate for the negative dH so S_f is positive)

The channel bed slope is S_o

$$S_o = -\frac{dz}{dx}$$

The energy equation $\frac{dH}{dx} = \frac{d}{dx}\left(y + \frac{V^2}{2g} + z\right)$

Only the kinetic energy change needs special treatment (other terms are straightforward).

$$-S_f = \frac{dy}{dx} + \frac{d}{dx}\left(\frac{V^2}{2g}\right) - S_o$$

For the kinetic energy change

$$\begin{aligned} \frac{d}{dx}\left(\frac{V^2}{2g}\right) &= \frac{d}{dx}\left[\frac{(Q/A)^2}{2g}\right] = \frac{Q^2}{2g} \frac{dA^{-2}}{dx} \\ &= -\frac{Q^2}{gA^3} \frac{dA}{dx} = -\frac{Q^2}{gA^3} \frac{Bdy}{dx} \quad (\text{Since } dA=dy B) \end{aligned}$$

so
$$-S_f = \frac{dy}{dx} - \frac{Q^2 B}{gA^3} \frac{dy}{dx} - S_o$$

Since
$$Fr^2 = \frac{V^2}{gD_m} = \frac{Q^2 B}{gA^3}$$

hence, the final general flow profile equation is

$$\frac{dy}{dx} = \frac{S_o - S_f}{1 - Fr^2}$$

From the Manning Equation (Replace S_o with S_f and $S_f \neq S_o$ for gradually varied flow)

$$V = \frac{R^{2/3} \sqrt{S_f}}{n} \quad \text{so} \quad S_f = \frac{n^2 V^2}{R^{4/3}}$$

The qualitative relationship between the relevant variables is as below.

$\frac{dy}{dx} = \frac{S_o - S_f}{1 - Fr^2}$			
$V = \frac{R^{2/3} \sqrt{S_f}}{n}$		$Fr = \frac{V}{\sqrt{gD_m}}$	
When $y > y_n$	$S_f < S_o$	When $y > y_c$	$Fr < 1$
When $y < y_n$	$S_f > S_o$	When $y < y_c$	$Fr > 1$

14.2 Classification of Surface Profiles

Flow surface profiles are classified based on the actual depth and the channel bed slope.

1) Depth

The depth space is divided into three regions by normal and critical depths.

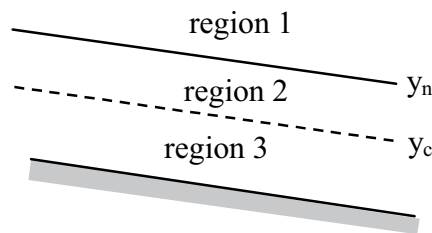

2) Slopes

The channel bed slopes are classified into five groups: **M** mild, **S** steep, **C** critical, **H** horizontal and **A** adverse.

<p>Mild slope</p>	<p>Steep slope</p>	<p>Critical slope</p>
<p>Horizontal Slope (No normal depth)</p>	<p>Adverse slope (No normal depth)</p>	

3) Profile name

A letter+ a digit e.g. M1, S2

where: Letter – the type of slope (M, S, C, H or A Digit – the region (1, 2 or 3)

14.3 Flow Profile Sketch

It is possible to sketch flow profiles based on the analysis of the general flow profile equation. Here is an example for a mild slope case.

Example: In a mild slope, if y is in Region 1, which profile is correct?

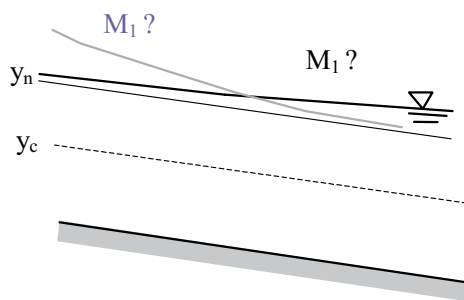

$$\frac{dy}{dx} > \text{ or } < 0 ?$$

STUDY AT A TOP RANKED INTERNATIONAL BUSINESS SCHOOL

Reach your full potential at the Stockholm School of Economics, in one of the most innovative cities in the world. The School is ranked by the Financial Times as the number one business school in the Nordic and Baltic countries.

Visit us at www.hhs.se



It is subcritical flow, so $Fr < 1$

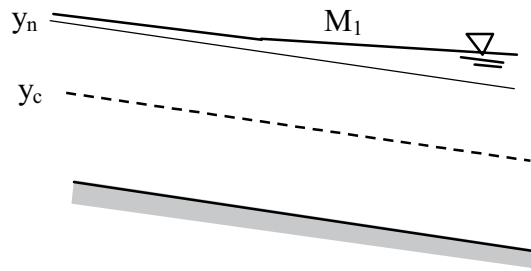

and $y > y_n$, so $S_f < S_o$

$$\frac{dy}{dx} = \frac{S_o - S_f}{1 - Fr^2} = \frac{\text{positive}}{\text{positive}} > 0$$

The profile with increasing depth is the correct answer.

Self Practice

For the same channel bed slope, if y is in Region 2, which profile curve is correct?

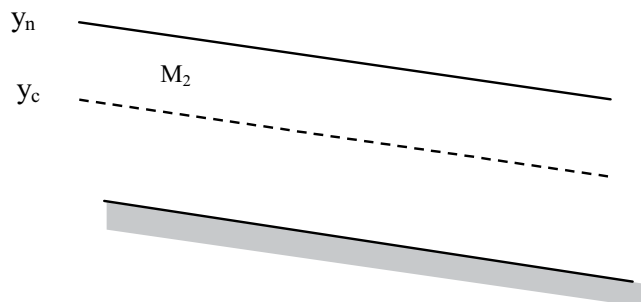
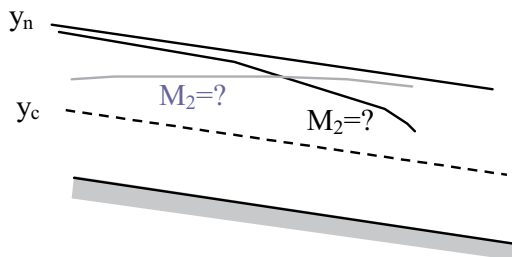

i.e. $\frac{dy}{dx} >$ or < 0 ?

i.e. $\frac{dy}{dx} >$ or < 0 ?

(Answer: the one with decreasing depth)

Steep slope cases (derived in the similar way as mild slope cases)

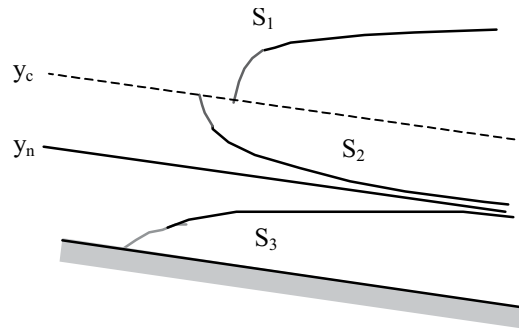

14.4 Flow transitions

1) *A smooth surface link*

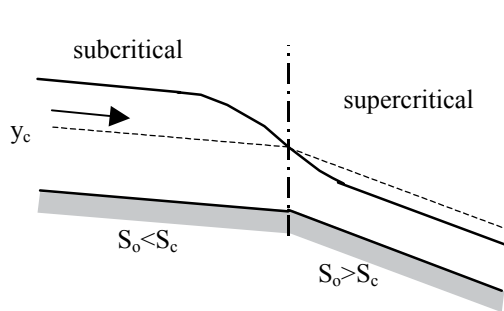

Subcritical to Subcritical
 Subcritical to Supercritical
 Supercritical to Supercritical

2) *Linked by hydraulic jump*

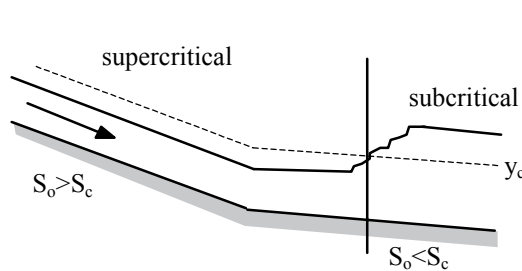

Supercritical to Subcritical

Questions 14
Gradually Varied Flow

- Water flows in a rectangular channel with a bottom slope of 0.8m/km and a head loss of 0.4m/km. At a section where the flow depth is 1.7m and the average velocity 1.8m/s, does the water depth increase or decrease in the direction of flow?

2. Roughly sketch the possible flow profiles in the channels shown below

a)

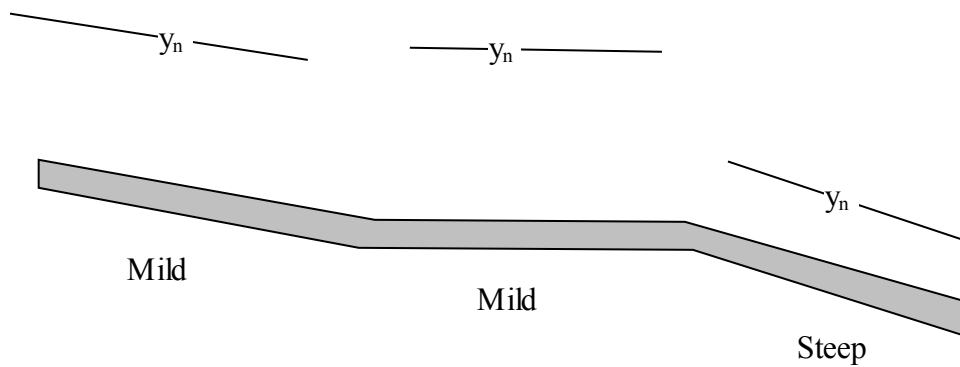

#1
in eco-friendly attitude

STUDY AT LINKÖPING UNIVERSITY, SWEDEN
RANKED AMONG TOP 50 UNIVERSITIES UNDER 50

Interested in Strategy and Management in International Organisations? Kick-start your career with a master's degree from Linköping University, Sweden.

→ **Click here!**

 **Linköping University**



b)

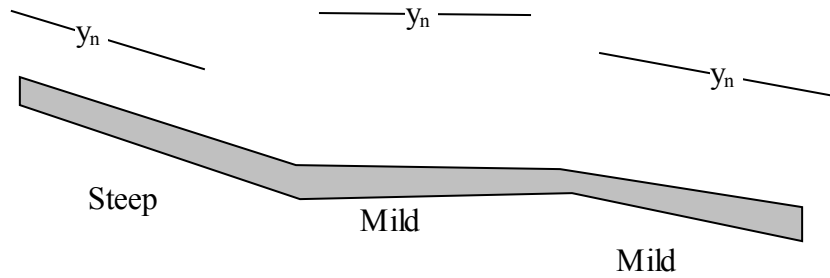

3) Show that the gradually varied flow equation is reduced to a uniform flow formula if $dy/dx=0$

Solutions 14
Gradually varied flow

1. The Froude number

$$Fr = \frac{V}{\sqrt{gy}} = \frac{1.8}{\sqrt{1.7g}} = 0.44, S_o=0.0008, S_f=0.0004$$

From the general flow profile equation

$$\frac{dy}{dx} = \left(\frac{S_o - S_f}{1 - Fr^2} \right) = \frac{0.0008 - 0.0004}{1 - 0.44^2} = 0.0005 > 0$$

so the flow depth is increasing.

2. a)

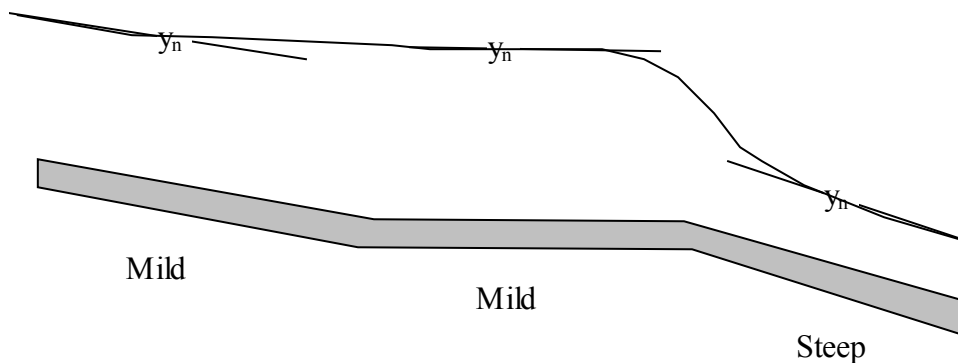

b)

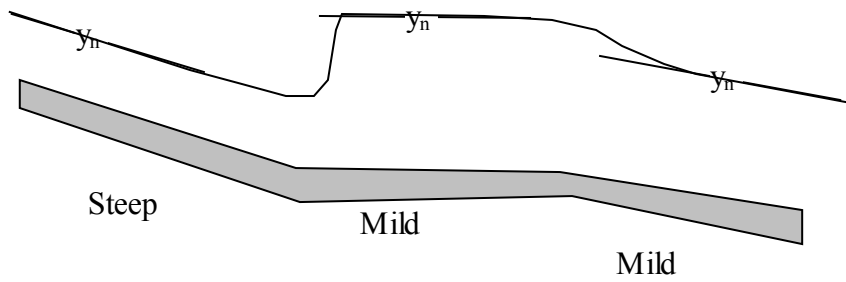

3. From $\frac{dy}{dx} = \frac{S_o - S_f}{1 - Fr^2}$

If, then $\frac{S_o - S_f}{1 - Fr^2} = 0$, i.e.

Since $S_f = \left(\frac{nQP^{2/3}}{A^{5/3}} \right)^2$

So $S_o = \left(\frac{nQP^{2/3}}{A^{5/3}} \right)^2$

Hence $Q = \frac{A^{5/3} \sqrt{S_o}}{nP^{2/3}}$ It is the Manning Equation for uniform flows.

15 Computation of Flow Profile

15.1 Introduction

The general flow profile equation is $\frac{dy}{dx} = \frac{S_o - S_f}{1 - Fr^2}$

It is possible to derive $y=f(x)$ from a simple differential equation. For example, if $dy/dx = 0.5$, the solution for it would be $y = x/2 + c$, where c is a constant. There are an infinite number of curves by changing the c value. To uniquely identify the profile, a control point is required (i.e., a boundary condition).



For example, if $y=3$ when $x=0$, the curve function would be fixed as $y = x/2 + 3$.

For practical flow profile computation, there are three types of solutions: 1. direct integration; 2. graphical integration; 3. numerical integration. The first two methods are superseded by numerical integration methods due to the widespread use of computers.

15.2 Numerical integration methods

1. *The direct step method:* to solve section length from depth.
2. *The standard step method:* to solve depth from section length.

1) The direct step method

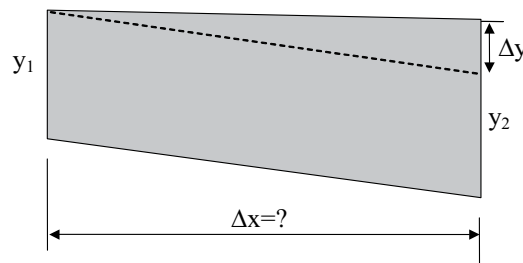

Known: y_1 and y_2 Unknown: $\Delta X=?$

By using a finite difference form

$$\Delta x = \Delta y \left(\frac{1 - Fr^2}{S_o - S_f} \right)_{mean}$$

where 'mean' refers to the mean value for the interval (Δx).

2) The standard step method

Known: y_1 and Δx Unknown: $y_2=?$

By using a finite difference form

$$\Delta y = \Delta x \left(\frac{S_o - S_f}{1 - Fr^2} \right)_{mean} \text{ (Iterations are required since } y_2 \text{ is unknown and the means of } S_f \text{ and } Fr \text{ need } y_2.)$$

For approximation, use

$$\Delta y = \Delta x \left(\frac{S_o - S_f}{1 - Fr^2} \right)_{Section1} \text{ to avoid iterations.}$$

"I studied English for 16 years but...
...I finally learned to speak it in just six lessons"
Jane, Chinese architect

ENGLISH OUT THERE

Click to hear me talking before and after my unique course download



15.3 Computation Procedure through an Example

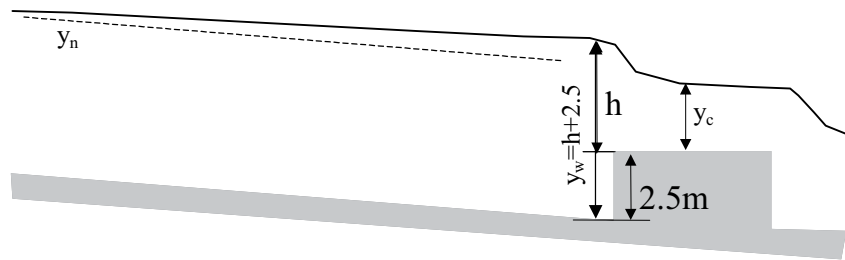

Determine the flow profile for the following conditions if 10 depth steps are used in the calculation:

- Channel: $Q=600\text{m}^3/\text{s}$,
- rectangular, width 50 m,
- $S_0=2\text{m}/\text{km}$, $n=0.04$
- Weir: $C_dC_v=0.88$
- Sill height: 2.5 m

Solution:

- a) The normal depth y_n from Manning's equation

$$Q = \frac{A^{5/3}\sqrt{S_0}}{nP^{2/3}} \quad \text{so} \quad 600 = \frac{(50y_n)^{5/3}\sqrt{0.002}}{0.04 \times (50 + 2y_n)^{2/3}}$$

By trial and error $y_n = 4.44\text{m}$

- b) The critical depth y_c

$$Q = AV_c = by_c\sqrt{gy_c}, \quad \text{so} \quad y_c = \left[\frac{(Q/b)^2}{g}\right]^{1/3} = \left(\frac{(600/50)^2}{g}\right)^{1/3} = 2.448\text{m}$$

- c) The depth over the weir (h)

From the weir equation $Q = 1.705C_dC_vBh^{3/2}$ then $600 = 1.705 \times 0.88 \times 50h^{3/2}$ so $h=4$ m

- d) The total depth over the weir (h_w)

$$y_w = h + 2.5 = 4 + 2.5 = 6.5 \text{ m}$$

$y_w > y_n > y_c$. This is a M1 type profile.

e) Profile computation

Take $y_w = 6.5$ m as the initial depth and $y = 4.5$ m (slightly greater than y_n) as the final depth, and proceed upstream at a small interval of depth

$$\Delta y = (4.5 - 6.5) / 10 = -0.2 \text{ m}$$

Simplify the formulas to be used as

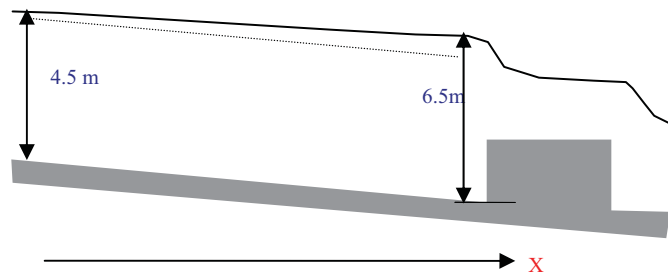

$$Fr = \frac{V}{\sqrt{gy}} = \frac{Q}{by\sqrt{gy}} = \frac{600}{50y\sqrt{gy}} = \frac{3.831}{y\sqrt{y}}$$

$$S_f = \left(\frac{nQP^{2/3}}{A^{5/3}} \right)^2 = \left(\frac{0.04 \times 600 P^{0.667}}{A^{1.667}} \right)^2 = \frac{576 P^{1.333}}{A^{3.333}}$$

$$\Delta x = \Delta y \left(\frac{1 - Fr^2}{S_o - S_f} \right)_{mean}$$

y	A	P	Fr	1-Fr ² mean	S _f	S _o -S _f mean	Dx	x
6.5	325	63.0	0.2312		0.0006			0
				0.9439		0.0014	-135	
6.3	315	62.6	0.2423		0.0007			-135
				0.9383		0.0013	-144	
6.1	305	62.2	0.2543		0.0007			-279
...								
4.9	245	59.8	0.3532		0.0015			-1491
				0.8669		0.0004		
4.7	235	59.4	0.3760		0.0017			-1920
				0.8488		0.0002		
4.5	225	59.0	0.4014		0.0019			-2769

Note: the negative values of x indicate that they are in the opposite direction of X .

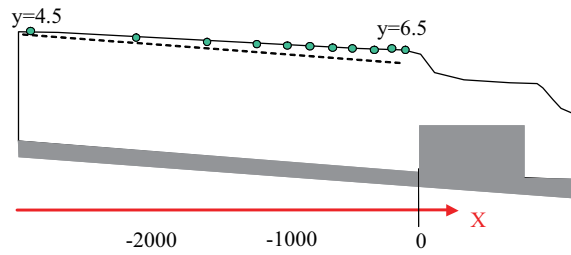

15.4 Further Computational Information

1) Computation steps for flow profiles

- a) find the critical and normal depths;
- b) find the slope type;
- c) find a control point with a known relationship between depth and discharge (weirs, flumes and gates):
 - i) Subcritical flow: its profile is controlled from downstream;
 - ii) Supercritical flow: its profile is controlled from upstream.

2) Computation direction

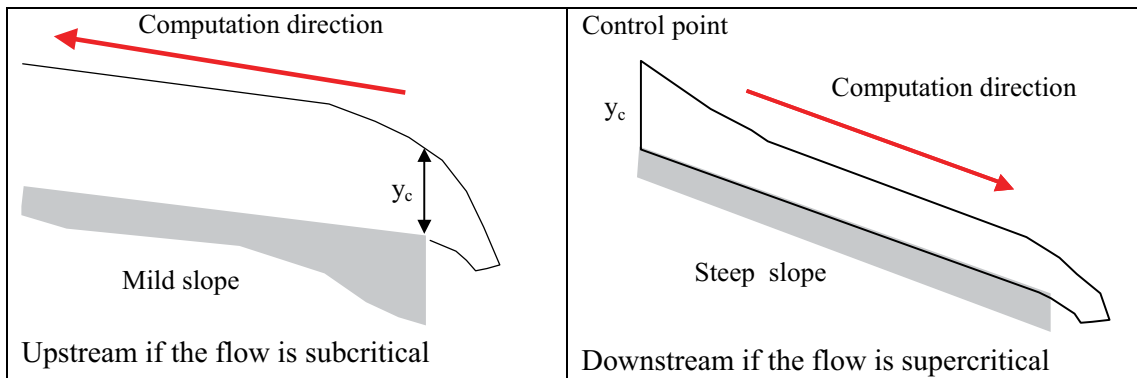

3) Locations of the control points

Subcritical flow

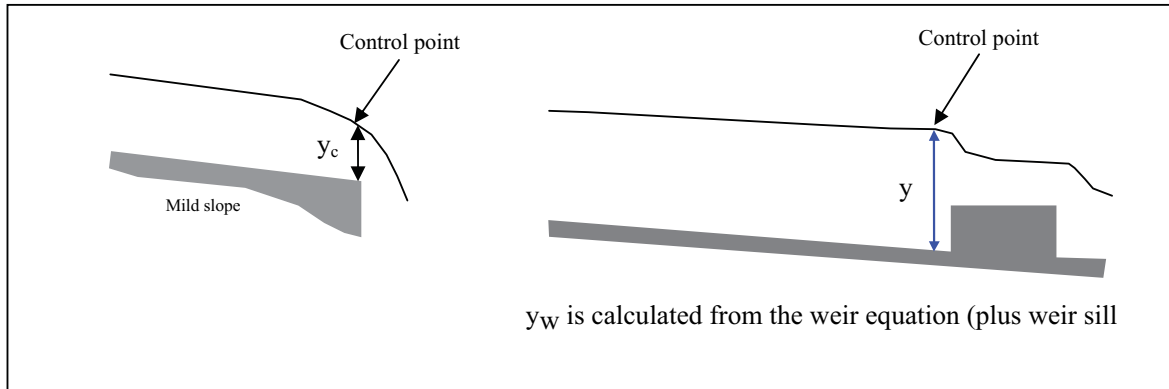

Excellent Economics and Business programmes at:



university of
 groningen



“The perfect start
 of a successful,
 international career.”

CLICK HERE
 to discover why both socially
 and academically the University
 of Groningen is one of the best
 places for a student to be

www.rug.nl/feb/education



Supercritical flow

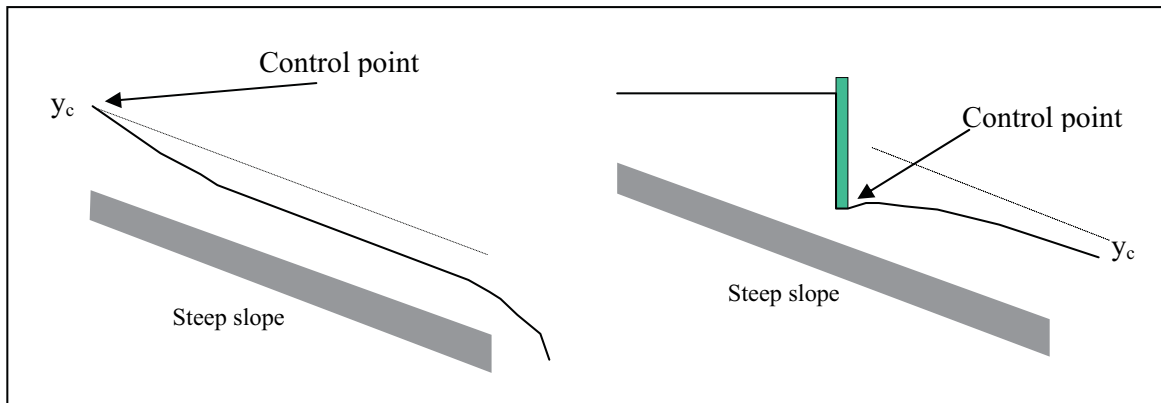

Questions 15
Computation of Flow Profile

1. A rectangular channel is 3.0 m wide, has a 0.01 slope, discharge of 5.3 m³/s, and n=0.011. Find y_n and y_c . If the actual depth of flow is 1.7 m, what type of profile exists?
(Answer: 0.4 m, 0.683 m, S1 curve)

2. A rectangular channel has a gradient of 2 in 1000 and ends in a free outfall. At a discharge of 4.53m³/s with Manning's n=0.012 and b=1.83m, how far from the outfall is the depth equal to 99% of normal depth if five depth steps are used in the calculation?
(Answer: 196.4 m)

Solutions 15
Computation of Flow Profile

1. From the Manning equation

$$A = by = 3y, P = b + 2y = 3 + 2y$$

$$\text{Since } Q = \frac{A^{\frac{5}{3}} \sqrt{S_0}}{nP^{\frac{2}{3}}} \text{ so } 5.3 = \frac{(3y)^{\frac{5}{3}} \sqrt{0.01}}{0.011(3 + 2y)^{\frac{2}{3}}}$$

Simplifying

$$0.093 = \frac{(y)^{5/3}}{(3 + 2y)^{2/3}}$$

Trial and error

y=1.0	0.342	
y=0.5	0.125	
y=0.3	0.057	
y=0.4	0.089	
y=0.45	0.107	close to 0.4

So $y_n=0.4$ m

From Froude number=1

$$Q = A\sqrt{gD_m} = By_c\sqrt{gy_c}$$

$$y_c^{\frac{3}{2}} = \left(\frac{Q}{B\sqrt{g}}\right)$$

so $y_c = \left(\frac{5.3^2}{3^2 g}\right)^{\frac{1}{3}} = 0.683m$

Since $y=1.7$ m, so $y_n < y_c < y$

This is a steep slope and the profile is S₁.

2. From the Manning equation

$$Q = \frac{A^{\frac{5}{3}}\sqrt{S_0}}{nP^{\frac{2}{3}}}$$

Since $A=by=1.83y$, $P=b+2y=1.83+2y$

The normal depth

$$4.53 = \frac{1}{0.012} 1.83y_n \left(\frac{1.83y_n}{1.83 + 2y_n}\right)^{\frac{2}{3}} \times 0.002^{1/2}$$

Simplifying

$$0.444 = \frac{y_n^{5/3}}{(1.83 + 2y_n)^{2/3}}$$

The right hand side

y=1.0	0.408	
y=1.1	0.463	
y=1.05	0.435	
y=1.07	0.446	close to 0.444

so $y_n = 1.07 \text{ m}$

The critical depth

$$y_c = \left(\frac{4.53^2}{1.83^2 g} \right)^{1/3} = 0.855 \text{ m}$$

Since $y_n > y_c$, the flow is subcritical and the water surface profile is M2.

In the past four years we have drilled

89,000 km

That's more than **twice** around the world.

Who are we?
We are the world's largest oilfield services company¹. Working globally—often in remote and challenging locations—we invent, design, engineer, and apply technology to help our customers find and produce oil and gas safely.

Who are we looking for?
Every year, we need thousands of graduates to begin dynamic careers in the following domains:

- Engineering, Research and Operations
- Geoscience and Petrotechnical
- Commercial and Business

What will you be?

careers.slb.com

Schlumberger

¹Based on Fortune 500 ranking 2011. Copyright © 2015 Schlumberger. All rights reserved.



The final depth $y = 0.99y_n = 0.99 \times 1.07 = 1.06m$

$$\Delta y = (1.06 - 0.855) / 5 = 0.041m$$

$$Fr = \frac{V}{\sqrt{gy}} = \frac{Q}{by\sqrt{gy}} = \frac{4.53}{1.83y\sqrt{gy}} = \frac{0.79}{y^{1.5}}$$

$$S_f = \left(\frac{nQP^{2/3}}{A^{5/3}} \right)^2 = \left(\frac{0.012 \times 4.53P^{0.667}}{A^{1.667}} \right)^2 = \frac{0.00296P^{1.333}}{A^{3.333}}$$

From $\Delta x = \Delta y \left(\frac{1 - F^2}{S_0 - S_f} \right)_{mean}$

The computations are shown in the following table:

Y	A	P	Fr	1-Fr ² mean	S _f	So-S _f mean	x
0.855	1.565	3.54	0.999		0.003588		0
				0.0676		-0.001375	
0.896	1.640	3.62	0.931		0.003162		-2.02
				0.1873		-0.000984	
0.937	1.715	3.70	0.871		0.002805		-9.82
				0.2869		-0.000658	
0.978	1.790	3.79	0.817		0.002511		-27.70
				0.3713		-0.000382	
1.019	1.865	3.87	0.768		0.002252		-67.6
				0.4430		-0.000141	
1.06	1.940	3.95	0.724		0.002029		-196.4

x= -196.4 m

16 Unsteady Flow

16.1 Basic Types

If the flow velocity at a point varies with time, the flow is called unsteady flow. They can be further divided into (in a similar way as to steady flow types):

- a) Rapidly varied unsteady flows: Surges and bores by dam break, quick operation of control structures, tidal effects
- b) Gradually varied unsteady flows: Translatory waves by flood waves, slow operation of control structures (gates, etc.)



American online
LIGS University
is currently enrolling in the
Interactive Online **BBA, MBA, MSc,**
DBA and PhD programs:

- ▶ enroll **by September 30th, 2014** and
- ▶ **save up to 16%** on the tuition!
- ▶ pay in 10 installments / 2 years
- ▶ Interactive Online education
- ▶ visit www.ligsuniversity.com to find out more!

Note: LIGS University is not accredited by any nationally recognized accrediting agency listed by the US Secretary of Education. More info [here](#).



16.2 Rapidly Varied Unsteady Flow

1) Dynamic Wave Propagation

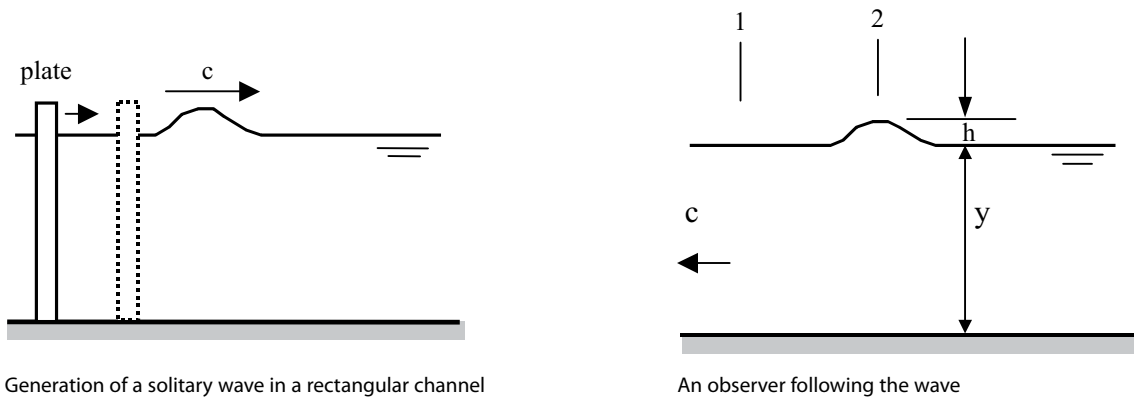

The energy equation

$$y_1 + \frac{V_1^2}{2g} = y_2 + \frac{V_2^2}{2g}$$

Since $y_1=y$, $y_2=y+h$, $V_1=c$, V_2 can be derived from the continuity equation $V_1y = V_2(y+h)$

Therefore

$$y + \frac{c^2}{2g} = y + h + \frac{c^2}{2g} \left(\frac{y}{y+h} \right)^2$$

Solving for c ,

$$c = \sqrt{\frac{2g(y+h)^2}{2y+h}}$$

for waves of small height $c = \sqrt{gy}$

Similarly, for non-rectangular channels $c = \sqrt{gD_m}$

where D_m – the hydraulic mean depth (A/B)

2) Surges & Bores

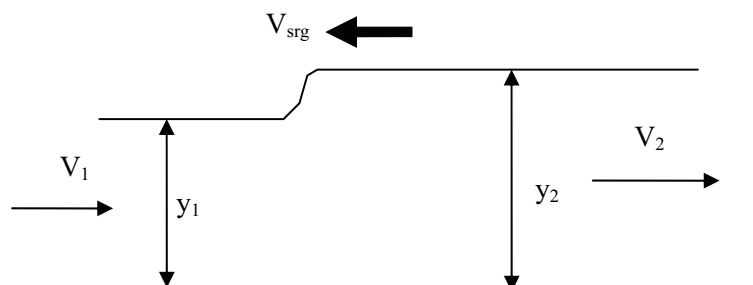

A surge wave results from a sudden change in flow (e.g., a partial or complete closure of a gate that increases the depth), called positive surge (similar to water hammers). It is termed as a bore if caused by tides. The momentum equation is used in a similar way to hydraulic jumps. A surge can be considered as a steady flow case if an observer is travelling at the surge speed.

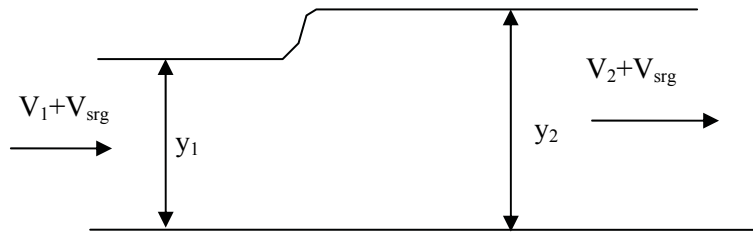

For a rectangular channel, the continuity equation is

$$(V_1 + V_{srg})y_1 = (V_2 + V_{srg})y_2$$

or simplified as
$$V_{srg} = \frac{V_1 y_1 - V_2 y_2}{(y_2 - y_1)}$$

The momentum equation

$$F_1 + M_1 = F_2 + M_2 \text{ (where } M = \rho QV \text{ and } F = \rho g A \bar{y} \text{)}$$

There are two equations so the two unknowns can be solved (with the three knowns). Iterations are usually required in the nonlinear calculations (assume $V_{srg} = 0$, calculate the other unknown from the continuity equation, then get V_{srg} from the momentum equation, enter it into the continuity equation again to get the other unknown, repeat the process until the required accuracy is achieved). Note, the surge velocity is much faster than small solitary waves.

16.3 Gradually Varied Unsteady Flows (Saint-Venant equations)

1) The Continuity Equation

At any time t , the outgoing velocity is

$$Q_2 = Q_1 + \frac{\partial Q}{\partial x} dx$$

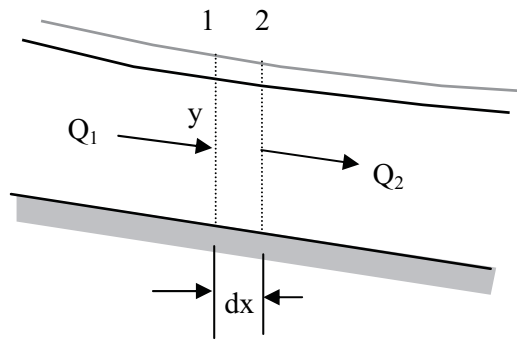

The net flow into the control volume (dx long) during dt period is

$$(Q_1 - Q_2)dt = \left(-\frac{\partial Q}{\partial x} dx \right) dt$$

.....Alcatel-Lucent 

www.alcatel-lucent.com/careers

What if you could build your future and create the future?

One generation's transformation is the next's status quo. In the near future, people may soon think it's strange that devices ever had to be "plugged in." To obtain that status, there needs to be "The Shift".



Click on the ad to read more

The storage change rate (the top part)

$$B \frac{\partial y}{\partial t} dx dt$$

Applying the conservation of mass

$$\frac{\partial Q}{\partial x} + B \frac{\partial y}{\partial t} = 0 \text{ or } \frac{\partial Q}{\partial x} + \frac{\partial A}{\partial t} = 0$$

The equation indicates that when the river level is going up with time ($\partial y / \partial t > 0$), the incoming discharge is greater than the outgoing discharge ($\partial Q / \partial x < 0$). This represents the flood wave's arrival.

2) The Momentum Equation (Dynamic equation)

From the momentum principle,

External Forces = Momentum Change Rate

The forces includes the gravity F_g , friction F_f along the channel bed and wall, and the pressure force F_p

Gravity

The total weight of water in the control volume is

$$W = \rho g A dx$$

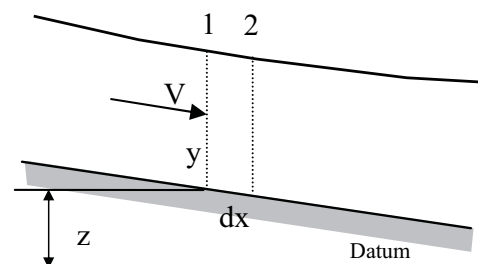

So

$$F_g = W \sin \theta = \rho g A dx \sin \theta \approx \rho g A dx S_o$$

(when the slope is mild, $S_o = \tan \theta \approx \sin \theta$)

Friction

The work done by friction force along distance dx is

$$F_r dx$$

This will result in the energy loss of water in the control volume (h_f)

$$Wh_f = \rho g Ah_f$$

So

$$F_r dx = Wh_f \text{ i.e. } F_r = Wh_f / dx = WS_f = \rho g A dx S_f$$

S_f is the friction slope (use the Manning, Chezy, etc. to estimate).

Pressure

The hydrostatic pressure force difference between Sections 1 and 2 is mainly caused by the extra depth increase at Section 2 to exert extra uniform pressure over cross section area A

$$F_p = (\rho g dy) A = \left(\rho g \frac{\partial y}{\partial x} dx \right) A$$

The momentum change rate

$$\text{Output - input } \frac{\partial(\rho QV)}{\partial x} dx$$

in the control volume with time

$$\frac{\partial[(\rho A dx)V]}{\partial t} = \rho \frac{\partial(AV)}{\partial t} dx$$

So
$$\rho g A S_o - \rho g A S_f - \rho g A \frac{\partial y}{\partial x} = \rho \frac{\partial(QV)}{\partial x} + \rho \frac{\partial(AV)}{\partial t}$$

Simplify and ignore wind effect

$$gA(S_o - S_f - \frac{\partial y}{\partial x}) = \frac{\partial(QV)}{\partial x} + \frac{\partial(AV)}{\partial t}$$

The right hand side can be expanded as

$$\frac{\partial(QV)}{\partial x} + \frac{\partial(AV)}{\partial t} = Q \frac{\partial V}{\partial x} + V \frac{\partial Q}{\partial x} + A \frac{\partial V}{\partial t} + V \frac{\partial A}{\partial t} = Q \frac{\partial V}{\partial x} + A \frac{\partial V}{\partial t}$$

(from continuity equation $\frac{\partial Q}{\partial x} + \frac{\partial A}{\partial t} = 0$)

So

$$g(S_o - S_f - \frac{\partial y}{\partial x}) = V \frac{\partial V}{\partial x} + \frac{\partial V}{\partial t}$$

Rearranging

$$S_f = S_o - \frac{\partial y}{\partial x} - \frac{V}{g} \frac{\partial V}{\partial x} - \frac{1}{g} \frac{\partial V}{\partial t}$$

or

$$S_o - S_f - \frac{\partial y}{\partial x} = \frac{V}{g} \frac{\partial V}{\partial x} + \frac{1}{g} \frac{\partial V}{\partial t}$$

Steady, uniform

Steady, nonuniform

Unsteady, nonuniform

Gravity

Friction

Pressure

Forces

With position

With time

Momentum change rate

The continuity and dynamic equations are also called the Saint-Venant equations

Solutions

Unknowns: V, y. Known: Initial and boundary conditions



Join the best at the Maastricht University School of Business and Economics!

Top master's programmes

- 33rd place Financial Times worldwide ranking: MSc International Business
- 1st place: MSc International Business
- 1st place: MSc Financial Economics
- 2nd place: MSc Management of Learning
- 2nd place: MSc Economics
- 2nd place: MSc Econometrics and Operations Research
- 2nd place: MSc Global Supply Chain Management and Change

Sources: Keuzegids Master ranking 2013; Elsevier 'Beste Studies' ranking 2012; Financial Times Global Masters in Management ranking 2012

Maastricht University is the best specialist university in the Netherlands (Elsevier)

Visit us and find out why we are the best!
Master's Open Day: 22 February 2014

www.mastersopenday.nl



Three methods:

- a) *Finite differences*: currently the most common method.
- b) *Characteristics*: suitable for the simple regular channel
- c) *Finite elements*: suitable for irregular boundaries

16.4 Software packages

1) Software packages for 1D river flows

Free Software

FLDWAV is a generalized flood routing model that can be used by hydrologists/ engineers for real-time flood forecasting of dam-break floods and/or natural floods, dam-breach flood analysis for sunny-day piping or overtopping associated with the PMF flood, floodplain inundation mapping for contingency dam-break flood planning, and design of waterway improvements. Its predecessors are DAMBRK, BREACH, DWOPER/NETWORK models that are also available from the same web site. Availability: *FLDWAV* version 2, June 2000.

http://www.nws.noaa.gov/oh/hrl/rvrmech/fldwav_instructions2.htm

HEC-RAS is (formerly HEC-2) is a comprehensive computer program designed to compute water surface profiles under a variety of conditions. The HEC-RAS software was developed at the Hydrologic Engineering Center (HEC). The system is capable of performing Steady Flow water surface profile calculations, and unsteady Flow, Sediment Transport, and several hydraulic design computations. HEC-RAS is the most widely used program by practitioners for the calculation of open channel flows. Its success is due to the detail that the program is able to handle. Availability: HEC-RAS version 4.0, November 2006, <http://www.hec.usace.army.mil/software/hec-ras/>.

Commercial Software

MIKE 11 is a professional engineering software package for the simulation of flows, water quality and sediment transport in estuaries, rivers, irrigation systems, channels and other water bodies. It is a dynamic, one-dimensional modelling tool for the detailed design, management and operation of both simple and complex river and channel systems. Availability: Purchase from DHI (Danish Hydraulic Institute), <http://www.dhisoftware.com/mike11/>.

ISIS models open channel systems containing loops, branches, floodplain conveyance and storage incorporates standard equations and modelling techniques for structures including weirs, sluices, bridges, culverts, pumps, siphons, orifices and outfalls, logical control of moving structures. Availability: Purchase from Wallingford Software Ltd, <http://www.wallingfordsoftware.com/products/isis.asp>.

2) Software packages for 2D river flows

Free packages

SSIIM: SSIIM is an abbreviation for Sediment Simulation In Intakes with Multiblock option. The program is designed to be used in teaching and research for hydraulic/river/sedimentation engineering. It solves the Navier-Stokes equations using the control volume method with the SIMPLE algorithm and the k-epsilon turbulence model. <http://www.bygg.ntnu.no/~nilsol/ssiimwin/>.

Commercial packages

MIKE21: MIKE 21 is the preferred 2D engineering modelling tool for rivers, estuaries and coastal waters. MIKE 21 consists of more than twenty modules covering the following areas: Coastal hydrodynamics; Environmental hydraulics; Sediment Processes; Wave processes, <http://www.dhisoftware.com/mike21/>.

3) Software packages for 3D river flows

Free packages

SSIIM: as above

Commercial packages

MIKE 3: MIKE 3 is applicable for simulations of hydrodynamics, water quality and sediment transport in all water bodies where 3D effects are important. MIKE 3 is compatible with MIKE 21 and other DHI Software products, allowing for easy model setup, transfer of boundary data, etc. <http://www.dhisoftware.com/mike3/>.

DELFT-3D: DELFT3D is a fully-integrated two or three-dimensional compound modelling system. It simulates the flows, waves, sediments, morphological developments and water quality aspects. The *sediment transport module* models bottom and suspended transport of sediment separately using a variety of formulae. The effects of wave motion on transport magnitude and direction are included. The *morphological module* computes bottom changes due to transport gradients and various types of boundary conditions. It can be run in a time-dependent way (coupling of hydrodynamics with computed bottom changes) or in a time-independent mode.

In the time dependent mode, animation's can be made of the bottom development over several years. <http://www.alkyon.nl/Tools/Delft3D.htm>

Questions 16
Unsteady Flow

1. The average depth of oceans is 3720m. Estimate the tsunami wave speed in km/hour based on the dynamic wave propagation equation and the average ocean depth.

(Answer: 687 km/hour)

2. There is a uniform flow of 4 m³/s of 0.6m deep in a rectangular channel of 4m wide. If the upstream gate is suddenly lifted up and the flow in the channel is increased to 6.7m³/s. Estimate the surge wave speed and wave height.

(Answer: 4.5m/s, 0.15m)

Solutions 16
Unsteady Flow

1. From the dynamic wave propagation equation

$$c = \sqrt{gy} = \sqrt{9.81 \times 3720} = 191 \text{ m/s} = 687 \text{ km/hour}$$



> Apply now

REDEFINE YOUR FUTURE
**AXA GLOBAL GRADUATE
PROGRAM 2015**

redefining / standards 

agence.cdg © Photonistop

2. The surge wave moves from the upstream to downstream,

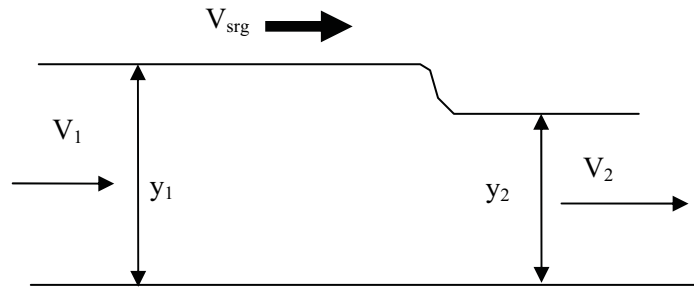

$$V_1 = Q_2 / (by_1) = 6.7 / (4y_1) = 1.68 / y_1$$

$$V_2 = Q_2 / (by_2) = 4 / (4 \times 0.6) = 1.67 \text{ m / s}$$

The surge can be considered as a steady flow case if an observer is travelling at the surge speed.

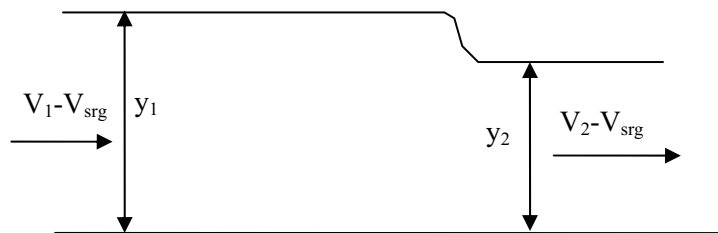

The continuity equation is

$$(V_1 - V_{srg})y_1 = (V_2 - V_{srg})y_2$$

$$\text{or simplified as } V_{srg} = \frac{V_1 y_1 - V_2 y_2}{(y_1 - y_2)} = \frac{1.68 - 1.67 \times 0.6}{y_1 - 0.6} = \frac{0.68}{y_1 - 0.6}$$

The momentum equation

$$F_1 + M_1 = F_2 + M_2 \text{ (where } M = \rho QV \text{ and } F = \rho g A \bar{y} \text{)}$$

$$\text{i.e., } \frac{1}{2} \rho g b y_1^2 + \rho Q_1 (V_1 - V_{srg}) = \frac{1}{2} \rho g b y_2^2 + \rho Q_2 (V_2 - V_{srg})$$

$$\text{so } 2gy_1^2 + 6.7(1.68 / y_1 - V_{srg}) = 2g(0.6)^2 + 4(1.67 - V_{srg})$$

$$\text{Simplify } 19.6y_1^2 + 11.3 / y_1 - 2.7V_{srg} = 13.7$$

$$\text{Substitute } V_{srg} \quad 19.6y_1^2 + 11.3 / y_1 - \frac{1.84}{y_1 - 0.6} = 13.7$$

With trial and error

$$y_1 = 1, \text{ LHS} = 26,$$

$$0.7, \text{ LHS} = 7.3$$

$$0.75, \text{ LHS} = 13.8 \text{ close to } 13.7$$

so $y_1 = 0.75m$, the wave height is $0.75 - 0.6 = 0.15m$

$$V_{srg} = \frac{0.68}{y_1 - 0.6} = \frac{0.68}{0.75 - 0.6} = 4.5m/s$$



Empowering People. Improving Business.

BI Norwegian Business School is one of Europe's largest business schools welcoming more than 20,000 students. Our programmes provide a stimulating and multi-cultural learning environment with an international outlook ultimately providing students with professional skills to meet the increasing needs of businesses.

BI offers four different two-year, full-time Master of Science (MSc) programmes that are taught entirely in English and have been designed to provide professional skills to meet the increasing need of businesses. The MSc programmes provide a stimulating and multi-cultural learning environment to give you the best platform to launch into your career.

- MSc in Business
- MSc in Financial Economics
- MSc in Strategic Marketing Management
- MSc in Leadership and Organisational Psychology

BI NORWEGIAN BUSINESS SCHOOL

EFMD **EQUIS ACCREDITED**

www.bi.edu/master



17 Hydraulic Machinery

Hydraulic machinery refers to a device either for converting the energy held by a fluid into mechanical energy (turbines) or vice versa (pumps).

17.1 Hydropower and Pumping Station

1) Energy of water in motion

The gross energy head = potential energy head + pressure energy+ kinetic energy

$$H = z + \frac{p}{\rho g} + \frac{V^2}{2g} \quad (\text{unit: metre})$$

Total water power from the gross energy head if expressed in Watt

$$P = \rho g H Q \text{ (Watt)}$$

where

P= total water power by gross energy head (Watt)

H= gross energy head (m)

Q= discharge (m³/s)

ρ=density of water (1000 kg/m³)

2) Efficiency

Efficiency of a hydraulic machinery device is measured as the ratio of energy output to input. The overall efficiency of a hydro power plant/pumping station is a product of the efficiencies of its several elements.

$$\eta_s = \eta_1 \eta_2 \dots \eta_n$$

Hydropower plant/pumping station output power

$$P_o = \eta_s P_i$$

where

P_i = Input power (Watt or K Watt)

P_o= Output power (Watt or K Watt)

η_s= Overall Efficiency

3) Hydroelectric power

Water is dammed and then diverted through a mechanical device to convert water's kinetic energy into rotational energy which can then be converted into electrical energy in a generator.

Advantages of Hydro Power	Limitations
a) Continuous low-cost production; b) No consumption of fossil fuel; c) Low maintenance cost; d) No air pollution; e) Reservoir can be used for recreation and other purposes (irrigation, water supply, etc.); f) Low insurance and low tax.	a) High initial cost; b) Loss of land suitable for agriculture; c) Relocation of highways, railroads, even small towns; d) Change of local environment; e) Long transmission line.

System Components

- a) Hydraulic Works; b) Power House; c) Turbines; d) Generators; d) Power lines.

Classification of Hydropower Plant

- a) Storage Plant has a reservoir of sufficient size to develop a firm flow substantially more than the minimum natural flow.

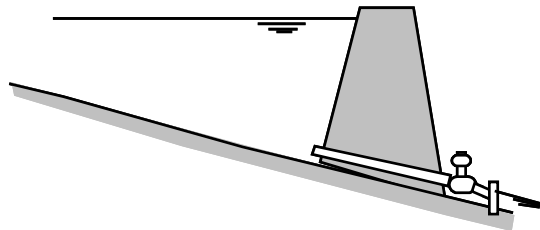

- b) Run-of-River Plant can use water only as it comes. It is cheaper than the storage plant of equal capacity, but suffers seasonal variation of output.

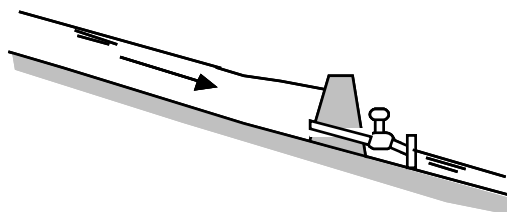

- c) Pumped Storage Plant generates energy at peak load and at off peak, water is pumped from the lower pool to upper pool.

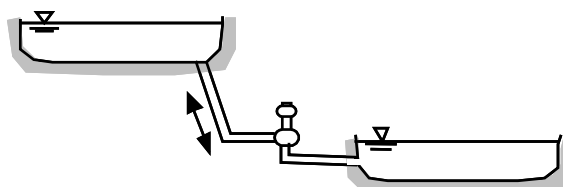

4) Pumping Station

Pumps play important role in various civil engineering projects. In water supply, pumps are necessary if gravitational flow could be not achieved. They are also used in urban sewers, drainage of low land, abstraction of water from bore hole, etc.

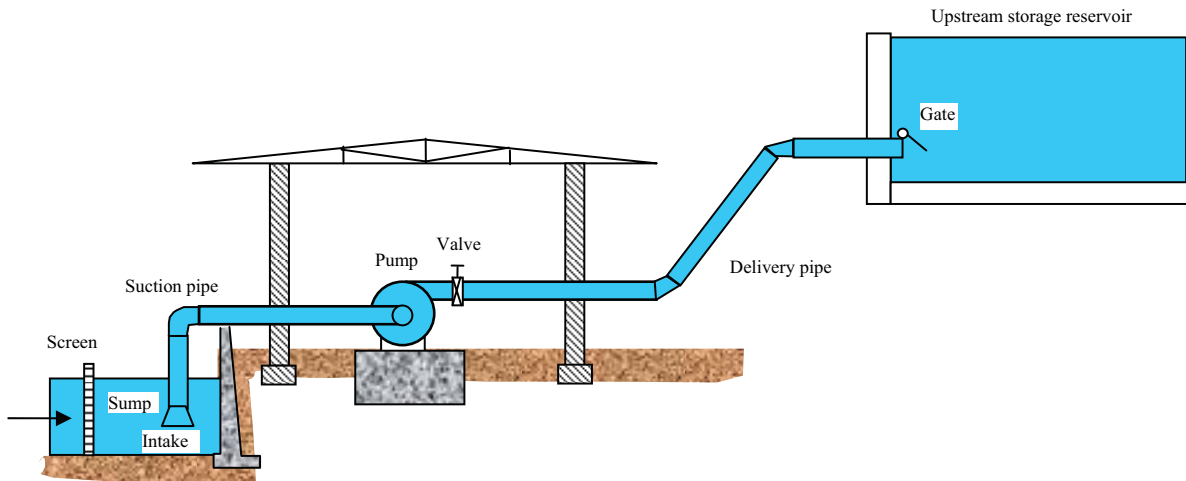

Classification of pumping stations

- a) *Abstraction from surface sources*: water is fed from an open-surface source such as canal, river, or a reservoir, often through a sump and intake. The water level may change over a large range and sediment trapping structure may be necessary.
- b) *Water supply from treatment plants*: treated water from treatment plants is usually supplied to a distribution network or a storage tower-reservoir through a pumping station. The water is clear and free from sediments, hence no screen and sediment settling structure is needed.
- c) *Storm water pumping*: storm water is full of suspended sediments and a coarse screen should be installed before the pump's intake. The pumping station is used intermittently.
- d) *Sewage (untreated) pumping*: a sewage pump should be able to pass all solid matter through its system. Stagnant areas or corners must be avoided.
- e) *Abstraction from borehole*: the pumps used are normally less bulky (around 100-400 mm diameter), which could be fitted into well diameters of 150-600mm.

17.2 Turbines

A turbine is a device that converts the energy in water into rotating mechanical energy.

1) Classification of Turbines

- a) *Impulse Turbines*: use water velocity to move the runner, rather than pressure (e.g., Pelton Wheel).
- b) *Reaction Turbines*: mainly use pressure rather than velocity (e.g., Francis turbine and Propeller turbine).

A Pelton Wheel is a disc with buckets attached to the outside edge. The jet strikes the buckets one at a time, causing the wheel to spin. For a Francis turbine, water is introduced just above the runner and all around it and then falls through, causing it to spin. A Propeller Turbine resembles a boat propeller running in a tube and operates on a similar principle. Type 'Pelton Wheel', 'Francis turbine' and 'Kaplan turbine' in Wikipedia for further information.

Selection of turbines is based on the following factors: performance (i.e. efficiency at various discharges), energy production, machine cost, availability, powerhouse construction cost, etc.

2) Hydraulics of Turbines

The geometry of turbines is specifically shaped so that the fluid exerts a torque on the rotor in the direction of its rotation. The shaft power generated is available to drive electric generators. The hydraulics of a Pelton Wheel is used here to illustrate the application of the momentum principle in turbine analysis. The wheel has a series of split buckets located around its periphery. When the jet strikes the dividing ridge of the bucket, it is split into two parts that discharge at both sides of the bucket. The speed of the wheel is kept constant under varying load through use of a governor that actuates a mechanism that changes the setting of the nozzle.

Need help with your dissertation?

Get in-depth feedback & advice from experts in your topic area. Find out what you can do to improve the quality of your dissertation!

Get Help Now



Go to www.helpmyassignment.co.uk for more info



Helpmyassignment



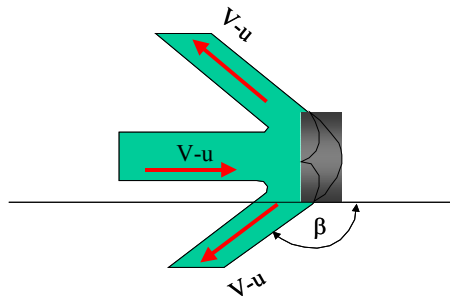

The momentum force is

$$F = \rho Q[(V - u) \cos \beta - (V - u)]$$

The force from water to the blades is

$$F_w = \rho AV(V - u)(1 - \cos \beta)$$

$$P = F_w u = \rho AV(V - u)(1 - \cos \beta)u$$

There is no power developed when $u=0$ or when $u=V$. For a given turbine and jet, the maximum power occurs at an intermediate u that can be found by differentiating the equation above and equating to zero.

$$\frac{dP}{du} = \rho AV(V - 2u)(1 - \cos \beta) = 0$$

from which $u=V/2$. Thus the greatest hydraulic efficiency (neglecting fluid friction) occurs when the peripheral speed of the wheel is half of the jet velocity.

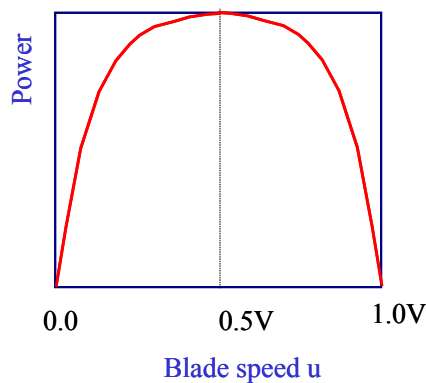

The maximum power

$$P_{\max} = 0.25\rho AV^3(1 - \cos \beta)$$

Torque

$$T_{\text{shaft}} = FR = R\rho AV(V - u)(1 - \cos \beta)$$

Pelton wheels are best suited (i.e., most efficient) for low flow rate and high head operations.

The efficiency of turbines is defined by

$$\eta = \frac{\text{power delivered to the shaft}}{\text{power taken from the water}} = \frac{T\omega}{\gamma Qh}$$

where T is the torque delivered to the shaft by the turbine, ω is the rotative speed in radians per second, Q is the discharge, and h is the net head on the turbine. The efficiencies of various types of turbines change with load. The impulse turbine maintains high efficiency over a wide range of loads, with significant decrease in efficiency occurring when the load drops below about 30% of normal load. The efficiency of propeller turbines is very sensitive to load, and a significant drop in efficiency is experienced as the load falls below the normal load. In contrast, the Kaplan turbine, with its adjustable blades, maintains high efficiency over a wide range

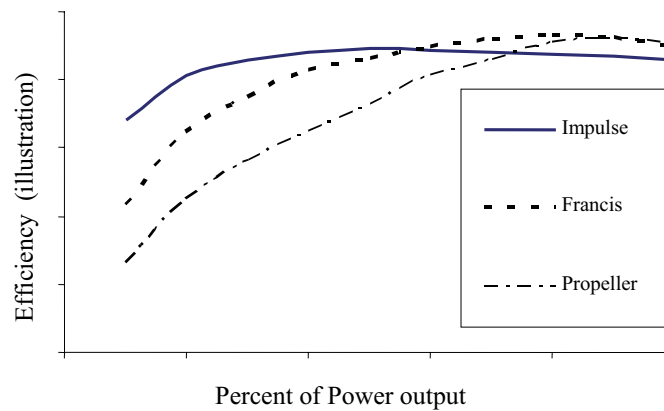

17.3 Pump and Pipeline

1) Performance curves

The following curves can be found using a pump test (or obtainable from the manufacturers)

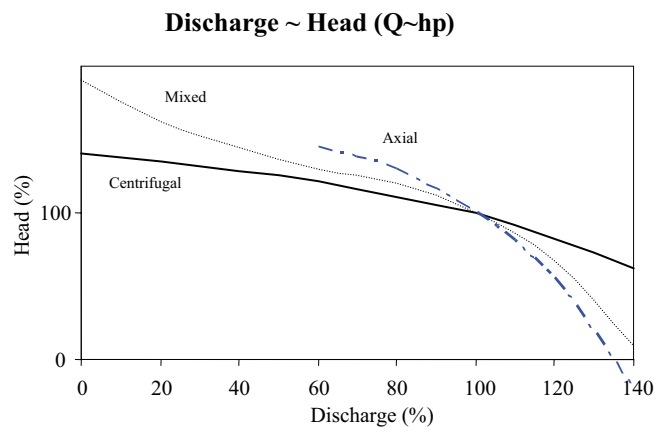

- Discharge and head $h_p \sim Q$,
- Discharge and power $P_s \sim Q$
- Discharge and efficiency $\eta \sim Q$

The discharge and efficiency curve is not independent and is derived from the other two curves.

Discharge and Head

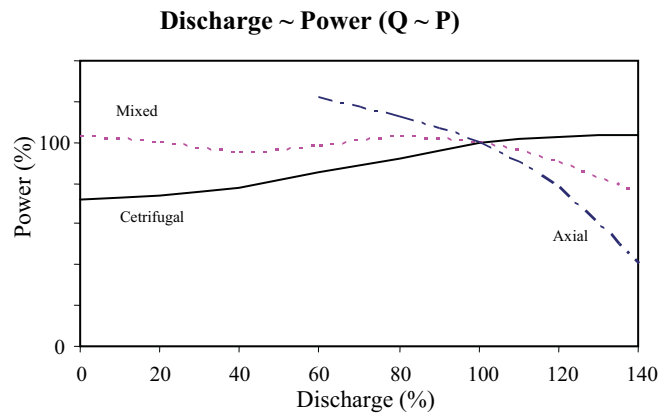

Brain power



By 2020, wind could provide one-tenth of our planet's electricity needs. Already today, SKF's innovative know-how is crucial to running a large proportion of the world's wind turbines.

Up to 25 % of the generating costs relate to maintenance. These can be reduced dramatically thanks to our systems for on-line condition monitoring and automatic lubrication. We help make it more economical to create cleaner, cheaper energy out of thin air.

By sharing our experience, expertise, and creativity, industries can boost performance beyond expectations. Therefore we need the best employees who can meet this challenge!

The Power of Knowledge Engineering

Plug into The Power of Knowledge Engineering.
Visit us at www.skf.com/knowledge





The discharge and head curve is the most important curve among the pump characteristics. It demonstrates that a pump can deliver a wide range of discharges but there will be the changes in pressure as the discharge changes. The speed of at which the pump runs can also change the discharge and head. Each curve is produced under a specified speed and several curves should be obtained from the manufacturers under different speeds so that a whole picture can be obtained. In the curve, the normal operating condition is represented as 100% and all other values are relative to this point. It can be seen that all pumps have higher heads at low discharge and lower heads when discharges go up.

Discharge and Power

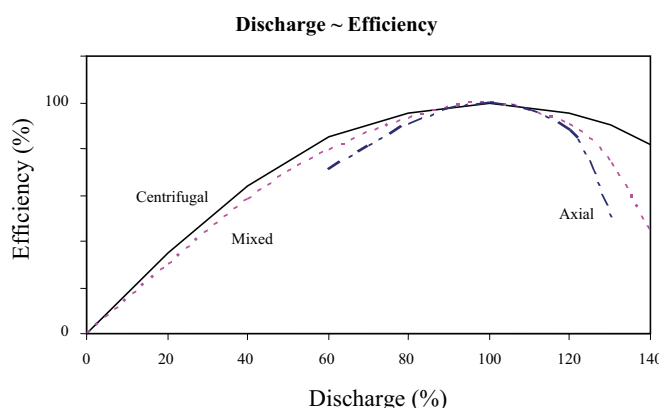

All pumps need power to rotate their impellers. The amount of power needed depends on the speed of a pump and the head and discharge required. For centrifugal pumps the power requirement is low when starting up but it rises steadily as the discharge increase. For axial pumps, the trend is different. There is a very large power demand when starting up and it will decrease as discharge increases. Mixed flow pumps lie in between other two types and their power consumption is more uniformly distributed.

Discharge and Efficiency

It is quite important to consider the pump efficiency under its operational conditions, because of losses occurring in transferring fuel energy to water energy via the power unit and pump. The losses are caused by friction and water turbulence. The maximum range of efficiency is usually between 30 and 80% so there is only limited range of discharges and heads over which pumps operate at maximum efficiency.

2) Initial pump selection

Many features of a pump are summarised into one factor, i.e., **specific speed**, which provides a common base for comparing pumps. It is the speed at which a pump will deliver 1m³/s at 1.0m head when operating at peak efficiency and is calculated as

$$n_s = n \frac{\sqrt{Q}}{h_p^{3/4}}$$

where *n* is rotational speed of the pump (rpm), *Q* is the pump discharge (m³/s), *H* is the pump head (m).

Specific speed is independent of the pump size so it describes the shape of the pump rather than how large it is.

Specific speed for different pumps (Kay 1998)

Pump type	Specific speed ns	Comments
Centrifugal	10~70	High head, low discharge
Mixed flow	70~170	Medium head, medium discharge
Axial flow	>170	Low head, large discharge

A user can calculate the specific speed required and check the table to find the suitable pump types.

3) Similarity and pump model

From dimensional analysis, the scaling law can be derived, so it is possible to experimentally determine the performance characteristics of one pump in the laboratory and then use these data to predict the corresponding characteristics for other pumps with the geometrically similar shape under different operating condition. The two geometrically similar pumps will have the same specific speed.

For two pumps with the geometric ratio $\lambda = L/L_M$,

$$\frac{Q}{Q_M} = \lambda_l^3 \frac{n}{n_M}, \quad (n \text{ is the angular speed of the pump rotor})$$

$$\frac{h_p}{h_{pM}} = \lambda_l^2 \left(\frac{n}{n_M} \right)^2, \quad \frac{P_s}{P_{sM}} = \lambda_l^5 \left(\frac{n}{n_M} \right)^3$$

For the same pump,

$$\frac{Q_1}{Q_2} = \frac{n_1}{n_2}, \quad \frac{h_{p1}}{h_{p2}} = \left(\frac{n}{n_M} \right)^2, \quad \frac{P_{s1}}{P_{s2}} = \left(\frac{n_1}{n_2} \right)^3$$

Example: A centrifugal pump having an impeller diameter of 1m is to be constructed so that it will supply a head rise of 200m at a discharge of 4.1m³/s of water when operating at a speed of 1200rpm. To study the characteristics of this pump, a 1/5 scale geometrically similar model operated at the same speed is to be tested in the laboratory. Determine the required model discharge and head rise based on the pump similarity law.

Solution:

The scale $\lambda_1 = 5$

From

$$\frac{Q}{Q_M} = \lambda_1^3 \frac{n}{n_M}, \quad Q_M = \frac{n_M Q}{n \lambda_1^3} = \frac{4.1}{5^3} = 0.0328 \text{ m}^3 / \text{s}$$

From

$$\frac{h_p}{h_{pM}} = \lambda_1^2 \left(\frac{n}{n_M} \right)^2, \quad h_{pM} = \frac{h_p}{\lambda_1^2} \left(\frac{n_M}{n} \right)^2 = \frac{200}{5^2} = 8 \text{ m}$$

4) Pump selection and pipeline

Duty Point

A duty point refers to the point in terms of head and discharge at which a pump normally operates. There are many pumps on the market and there may be several that can meet the duty point or near it. The next is to examine the efficiency of each pump at the duty point and select the one that will operate near the maximum efficiency.

What do you want to do?

No matter what you want out of your future career, an employer with a broad range of operations in a load of countries will always be the ticket. Working within the Volvo Group means more than 100,000 friends and colleagues in more than 185 countries all over the world. We offer graduates great career opportunities – check out the Career section at our web site www.volvogroup.com. We look forward to getting to know you!

VOLVO
AB Volvo (publ)
www.volvogroup.com

VOLVO TRUCKS | RENAULT TRUCKS | MACK TRUCKS | VOLVO BUSES | VOLVO CONSTRUCTION EQUIPMENT | VOLVO PENTA | VOLVO AERO | VOLVO IT
VOLVO FINANCIAL SERVICES | VOLVO 3P | VOLVO POWERTRAIN | VOLVO PARTS | VOLVO TECHNOLOGY | VOLVO LOGISTICS | BUSINESS AREA ASIA

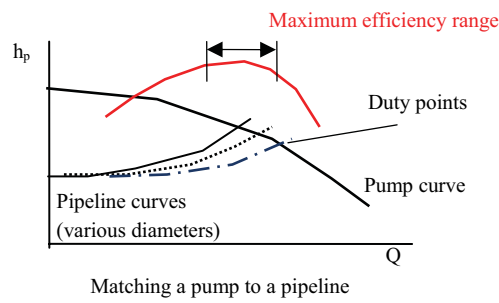

The pipeline could have a few diameter options and several pipeline curves could be generated by the hydraulic loss equation. Select the diameter which could make the duty point within the maximum efficiency range. Several pumps and various diameters should be compared and economic analysis considering the initial capital cost and running cost of the whole system should be used as the final decision criterion.

Example: Water is to be pumped from a river through a 150mm diameter pipeline 950m long to an open storage tank with a water level 45m above the river. A pump is available and has the discharge ~ head performance characteristics shown below. Calculate the duty point for the pump when the friction factor $\lambda=0.04$ (ignore local losses).

Pump head (m)	30	50	65	80
Discharge (litre/m)	2000	1750	1410	800

Solution:

Calculate the pipeline curve with $\lambda=0.04$, $L=950\text{m}$ and $D=0.15\text{m}$

$$h_f = \lambda \frac{L V^2}{D 2g}$$

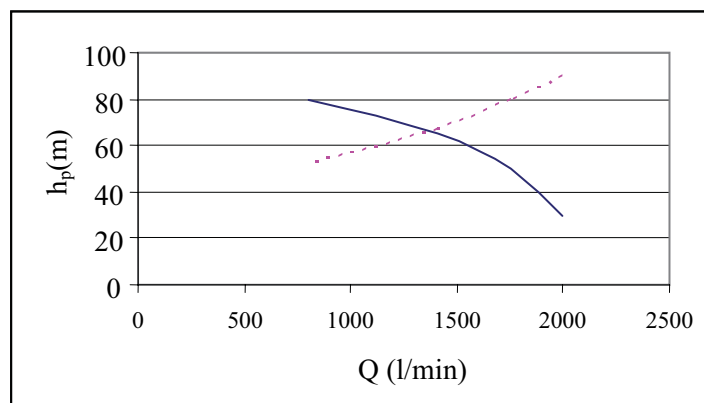

For different discharge, we can derive

Q	hf	hf+45m
2000	46.0	91.0
1750	35.2	80.2
1410	22.9	67.9
800	7.14	52.4

The duty point can be found at $Q = 1400 \text{ l/s}$, $H = 65 \text{ m}$

Series and parallel arrangement

When the required flow or head is greater than a single centrifugal pump, two or more pumps could be combined to meet the demand. Also if the demand varies greatly with time, it is desirable to have a few smaller pumps that can be run in parallel instead of a single one.

To increase the head, two or more identical pumps are operated in series. The same flow passes through Pump 1 and Pump 2 so that the discharge is the same as individual pumps but the head is doubled (in case of two pumps). The discharge-head curve for two pumps can be obtained by taking the curve for one pump and doubling the head for each value of discharge. Like in series electricity circuit, the whole system breaks down when one pump stops.

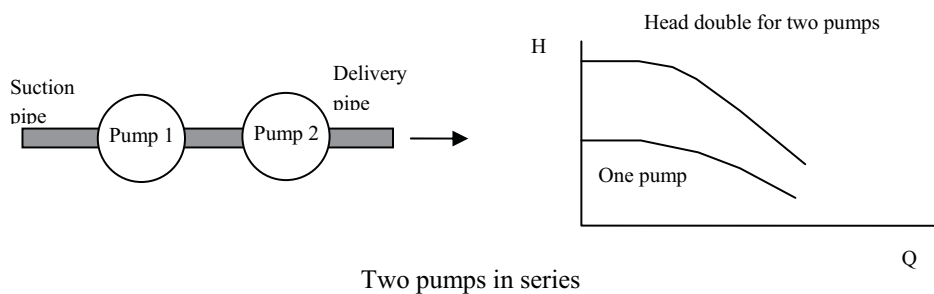

Two pumps in series

To increase the discharge, two or pumps could be operated in parallel. Again the pumps must be identical, have individual suction pipes but share a common delivery pipe. The head is the same as for a single pump but the discharge is doubled. The discharge-head curve is obtained by taking the curve for one pump and doubling the discharge for each value of head. Usually one pump is used to provide low flow demand and other pumps are used to provide extra flow when the demand is increased.

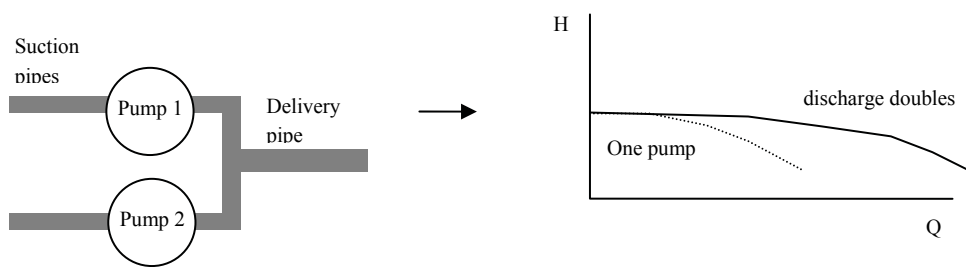

Two pumps in parallel

Cavitation and safe installation height

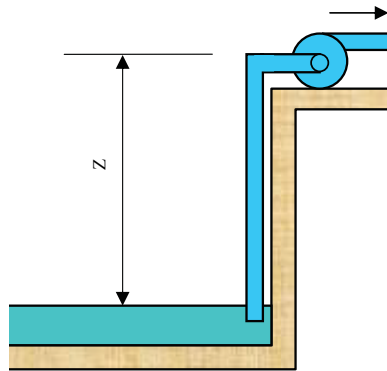

When a pump is operating, it draws water from the sump and the water is pushed by the atmospheric pressure. At the sea level, the atmospheric pressure is about 10m of water head and would be considerably less in high mountains. Considering the hydraulic loss along the pipeline, the practical limit is below 7 meters. In addition, low pressure will increase the possibility of cavitation within the pump, which occurs when the liquid pressure at a given location is reduced to vapour pressure of the liquid. When this occurs, vapour bubbles form (the liquid starts to ‘boil’). Cavitation can cause a loss in efficiency as well as structural damage to the pump. To decide the maximum elevation for a pump installation, an important parameter is introduced: $NPSH_R$ (Net Positive Suction Head), which is a value provided by pump manufacturers as a reference for limiting suction lift under each discharge to ensure that a pump operates satisfactorily.



The actual NPSH for an installation can be calculated as $NPSH_a = P_a - Z - V_p - h_L$

where P_a is the atmospheric pressure (m), Z is the elevation difference between the pump and intake water level (m), V_p is the vapour pressure of water (approximately 0.5m, depending temperature) and h_L is the head loss in the suction pipe (approximately 0.75m, local loss is more dominant). To prevent cavitation, it is necessary that

$$NPSH_A \geq NPSH_R$$

Example:

A centrifugal pump is to be placed above a large open water tank with discharge 14 litres/s. The required net positive suction head (NPSHR) is 4.6 m, as specified by the pump manufacturer. If the water temperature is 27°C and atmospheric pressure is 101.353 KPa, determine the maximum height Z , that the pump can be located above the water surface without cavitation. Ignore the friction loss, and the local loss is mainly caused by a special inlet filter with $K_L=20$. The diameter of the inlet pipe is 10cm.

The water properties are

Temperature (°C)	0	4	10	20	30	40
Density (kg/m³)	999.9	1000.0	999.7	998.2	995.7	992.2
Vapour pressure (N/m²)	610.5	872.2	1228	2338	4243	7376

Solution

The energy loss $h_L = K_L \frac{V^2}{2g} = 20 \frac{[0.014 / (0.05^2 \pi)]^2}{2g} = 3.24m$

From the table, water at 27°C, density = 996 kg/m³, vapour pressure = 3671 N/m²,

From $NPSH_a = P_a - Z - V_p - h_L \geq NPSH_R$

So

$$101353 / (996g) - Z - 3671 / (996g) - 3.24 \geq 4.6,$$

$$Z \leq 2.16m$$

Surges in pumping stations

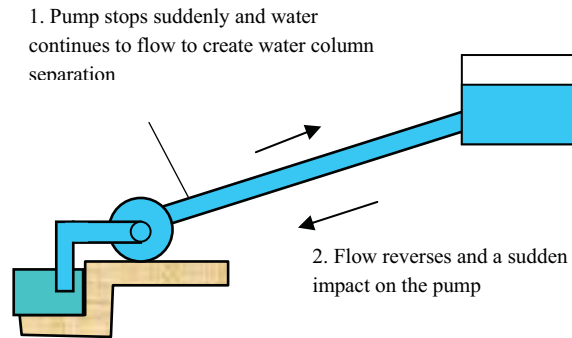

Water hammer can cause damages to the pipelines and this could also be a problem for pump mains, which is the slower mass movement of water often resulting from the faster-moving water hammer shock waves. When a pump stops, the flow in the pipe does not stop immediately but continues to move along the pipe. Since the driving force is gone and the water will gradually slow down due to friction. As the flow moves away from the pump and no water enters the pipe, the empty space forms near the pump. This is called water column separation and pressure in the empty space drops rapidly to the vapour pressure. Then the water begins to flow back towards the pump gathering speed as it goes, and comes to a sudden stop as it hits the pump (similar to a sudden closure of a valve on a pipeline). This could burst the pipe and the pump.

Possible solutions are:

- 1) Stop pumps slowly: This will avoid the water column separation and minimise the surge. Diesel pumps are more suitable for this solution since they stop gradually after the fuel is cut off, while electric pumps usually have sudden stop when the electricity is switched off.
- 2) Use a non-return valve: it will allow water to pass in one direction only and protect the pump (not the pipeline) when water flows back.

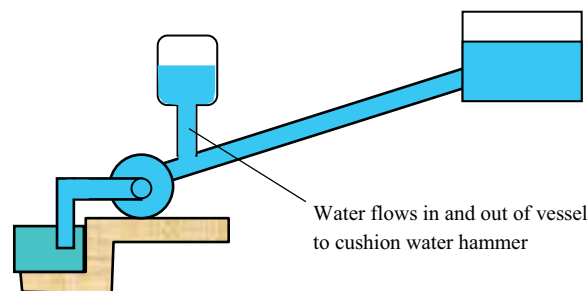

- 3) Use an air vessel: This is similar to a surge tank. When a pump stops and pressure starts to drop, water flows from a pressured tank into the pipeline to fill the void and stop the water column from separating, and water is allowed to flow back into the tank when the flow is reversed. The water will oscillate back and forth until it eventually stops through friction (much like a car shock absorbers). This device is expensive and should be used only for large scale pump stations where serious water hammers are expected.

Questions 17
Hydraulic Machinery

1. Each day 600m^3 of water is pumped by 10m to a tank above the ground. Calculate the amount of power required to do this (assume the system is 100% efficient and there is no energy loss in the pipeline).

(Answer: about 0.7 kW)

2. A Hydraulic power plant takes in $30\text{m}^3/\text{s}$ of water through its turbine and discharges it at $V=2\text{m/s}$ at atmospheric pressure. The head loss in the turbine and conduit system is 20 meters. Estimate the power extracted by the turbine.

(Answer: 23.5 MW)

This e-book
is made with
SetaPDF

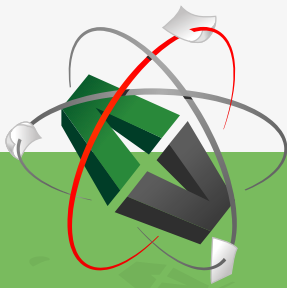

PDF components for PHP developers

www.setasign.com



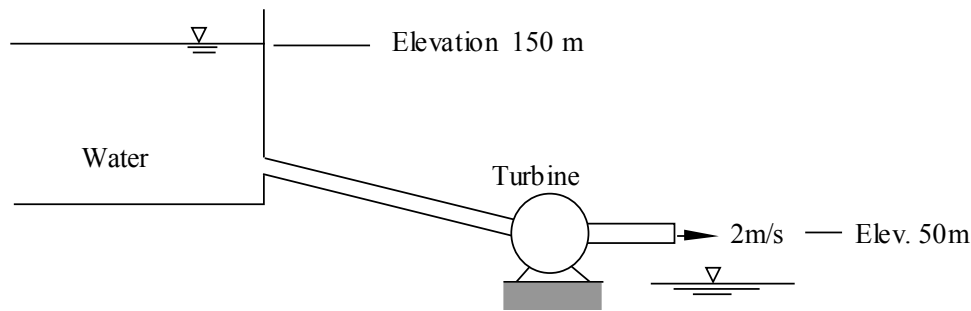

3. A power plant is to be built on a stream capable of utilising a flow up to $1 \text{ m}^3/\text{s}$ with a gross head of 40m at 78 percent overall efficiency. Assume the stream has enough flow to maintain the plant working at full capacity continuously and the power is valued at £0.05 per kilowatt-hour. What annual revenue could be expected from this plant?

(Answer: £134,000)

4. A Pelton Wheel is to be selected to drive a generator at 600rpm. The water jet is 75mm in diameter and has a velocity of 100m/s. With the blade angle at 170° , the ratio of vane speed to initial jet speed at 0.47, and neglecting losses, determine 1) diameter of wheel to centerline of buckets (vanes); 2) power developed. (Note $P = \rho AV(V - u)(1 - \cos \beta)u$)

(Answer: 1.497m, 2.18 MW)

Solutions 17
Hydraulic Machinery

1. Convert discharge to m^3/s

$$Q = 600 / 24 / 3600 = 0.007 \text{ m}^3 / \text{s}$$

$$P = \rho g H Q = 1000 \times 9.81 \times 10 \times 0.007 = 686 \text{ W} \approx 0.7 \text{ kW}$$

2. Set up the energy equation between the reservoir surface and the turbine outlet

$$z_1 + \frac{V_1^2}{2g} = z_2 + \frac{V_2^2}{2g} + h_L + H$$

so $100 = \frac{2^2}{2g} + h_L + H$

With $h_f = 20\text{m}$, so $H = 100 - 20 - 0.2 = 79.8 \text{ m}$

Power extracted by turbine will be

$$P = \rho g Q H = 1000 \times 9.81 \times 30 \times 79.8 = 23.5 \text{ MW}$$

$$\begin{aligned}
 3) \text{ Power output } P &= \eta \rho g Q H / 1000 \text{ kW} \\
 &= 0.78 \times 1000 \times 9.81 \times 1 \times 40 / 1000 \\
 &= 306.1 \text{ kW}
 \end{aligned}$$

$$\text{Annual revenue} = P \times 365 \times 24 \times 0.05 = \text{£}134.1 \times 10^3$$

So the annual revenue from this plant will be 134 thousand pounds.

$$4) \text{ 1) The peripheral speed of the wheel is } u = 0.47 \times 100 \text{ m/s} = 47 \text{ m/s}$$

$$\frac{u}{\pi D} \times 60 = 600 \text{ rpm} \text{ so } D = \frac{u}{600\pi} \times 60 = \frac{47}{10\pi} = 1.497 \text{ m}$$

$$2) \text{ The power is } P = \rho A V (V - u)(1 - \cos \beta) u$$

$$\begin{aligned}
 \text{so } P &= 1000 \frac{\pi \times 0.075^2}{4} 100(100 - 47)(1 - \cos 170^\circ) 47 \\
 &= 2183154 \text{ W} = 2.18 \text{ MW}
 \end{aligned}$$



www.sylvania.com

**We do not reinvent
the wheel we reinvent
light.**

Fascinating lighting offers an infinite spectrum of possibilities: Innovative technologies and new markets provide both opportunities and challenges. An environment in which your expertise is in high demand. Enjoy the supportive working atmosphere within our global group and benefit from international career paths. Implement sustainable ideas in close cooperation with other specialists and contribute to influencing our future. Come and join us in reinventing light every day.

Light is OSRAM

**OSRAM
SYLVANIA** 

18 Appendix: Further Reading Resources

The following resources are highly recommended if you want to further explore the interested topics in hydraulics. This is not an exhaustive list and will be updated regularly in the future. You are welcome to recommend useful books/web sites that are not on the list.

Biswas, A.K., 1970, History of Hydrology, North-Holland Publishing Company

Chadwick, A., Morfett, J. and Borthwick, 2004, Hydraulics in Civil and Environmental Engineering, 4th Edition, Spon Press

Chanson, H., 1999, The Hydraulics of Open Channel Flow, Butterworth-Heinemann, Oxford

Chow, V.T., 1959, Open Channel Hydraulics, McGraw-Hill College

Evetts, J.B. and Liu, C., 1989, 2500 solved problems in Fluid Mechanics & Hydraulics, McGraw Hill

French, R.H., 1985, Open-Channel Hydraulics, McGraw-Hill

IAHR, 2008, Media Library, <http://www.iahrmedialibrary.net/>

Kay, M., 1998, Practical Hydraulics, E&FN Spon

Liggett, J.A. and Caughey, D.A., 1999, Fluid Mechanics, ASCE Press

Munson, B.R., Yong, D.F. and Okiishi, T.H., 2002, Fundamentals of Fluid Mechanics, John Wiley and Sons.

Novak, P., Moffat, A, Nalluri, C. and Narayanan, 1996, Hydraulic Structures, Second Edition, E & FN Spon

Wikipedia, 2008, 'Hydraulics', 'Hydrostatics', ... <http://en.wikipedia.org/wiki/Hydraulics>